

CLOVER



NATURALMENTE
AUTENTICA
NATURALLY AUTHENTIC

La cucina è l'ambiente che da sempre sta al centro della casa e che è destinata ad accogliere la parte più vera ed emozionale della nostra vita domestica. Clover è stata creata per durare nel tempo, grazie ai materiali con i quali potrete vestirla. La naturale bellezza delle essenze materiche, i legni, abbinati ai colori ed ai materiali che più raccontano il mondo della natura. Clover è fatta di questo. Autentica e naturale declinabile in mille forme, dalla più razionale, squadrata ed essenziale, alla più sinuosa, stondata ed eclettica, è una cucina che saprà rispondere alle più diverse esigenze arredative.

The kitchen is a space that has always been the heart of any home. It should be the setting for the most authentic and emotional parts of our domestic lives. Clover is designed to last, thanks to the materials you can use to clothe it. The natural beauty of tactile wood finishes is combined with colours and materials that evoke the world of nature. This is Clover. Authentic, natural and available in a thousand different shapes, from the most rational, square and minimalist, to the most sinuous, rounded and eclectic. This is a kitchen that can adapt to the most diverse furnishing requirements.

Neck

ANTA SENZA PROFILO PER APERTURA CON GOLA

DOOR WITHOUT PROFILE
FOR FINGER RAIL OPENING



ANTA SQUADRATA
SQUARE DOOR

GOLA TIPO "ELLE"
"ELLE" TYPE FINGER RAIL

LUX

ANTA CON PROFILO PER APERTURE CON GOLA

DOOR WITH PROFILE
OPENINGS WITH FINGER RAIL

LA TIPOLOGIA LUX OFFRE ANTE ARRICCHITE
DA UN PROFILO IN METALLO, CURVO OPPURE
AD "ELLE", CHE HA LA CARATTERISTICA DI
PRESERVARE IL BORDO DELL'ANTA STESSA.

THE LUX RANGE OFFERS DOORS EMBELLISHED WITH METAL
EDGES THAT ARE EITHER CURVED OR "L" TYPE. THESE PROTECT
THE EDGES OF THE DOOR ITSELF.

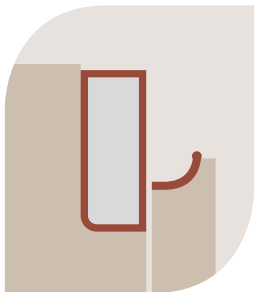

GOLA PIATTA
FLAT FINGER RAIL

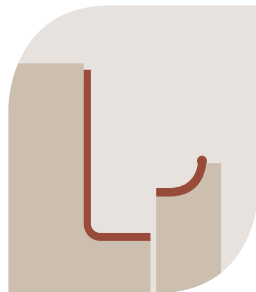

GOLA TIPO "ELLE"
"ELLE" TYPE FINGER RAIL

ANTA CON PROFILO CURVO

DOOR WITH CURVED PROFILE

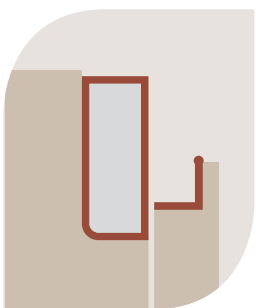

GOLA PIATTA
FLAT FINGER RAIL

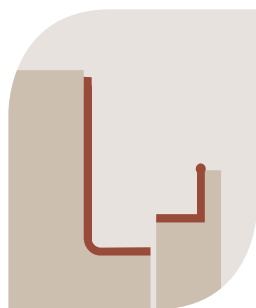

GOLA TIPO "ELLE"
"ELLE" TYPE FINGER RAIL

ANTA CON PROFILO AD "ELLE"

DOOR WITH "ELLE" SHAPED PROFILE

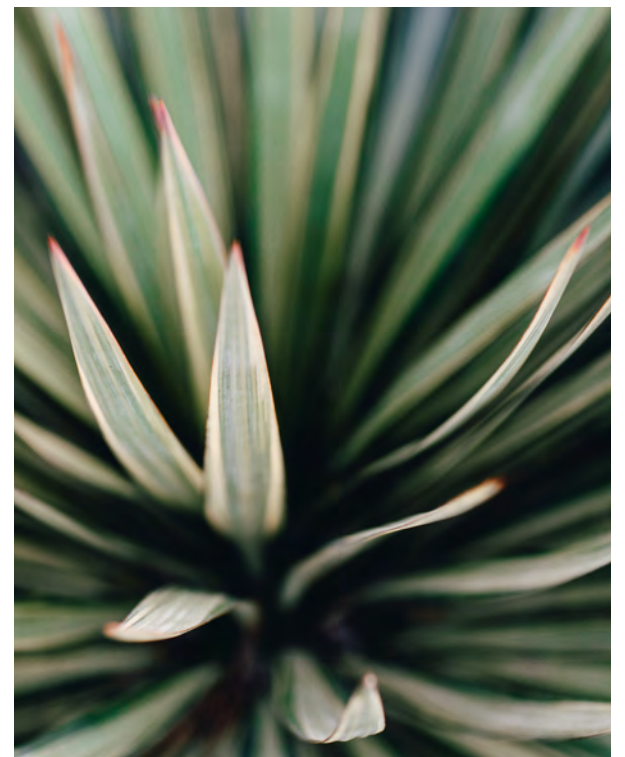

Bridge

ANTA QUADRATA CON MANIGLIA

SQUARE DOOR WITH HANDLE

MANIGLIA FRONTALE, APPLICATA IN TESTA O AD INCASSO, OPPURE TECNOLOGIA PUSH/PULL PER GLI AMANTI DELLO STILE MINIMAL. LA TIPOLOGIA DI APERTURA BRIDGE, CON LE SUE VARIANTI ESTETICHE E FUNZIONALI, SAPRÀ FORNIRE LA GIUSTA SOLUZIONE AD OGNI ESIGENZA.

FRONT HANDLE, APPLIED AT THE END OR RECESSED, OR WITH PUSH-PULL TECHNOLOGY FOR THOSE THAT LOVE THE MINIMALIST LOOK. THE BRIDGE OPENING WITH ITS AESTHETIC AND FUNCTIONAL VARIANTS IS ABLE TO OFFER THE RIGHT SOLUTION FOR ANY REQUIREMENT.

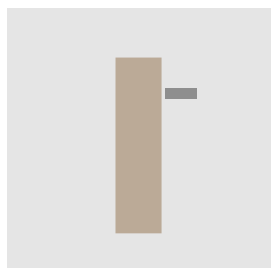

FRONTALE
anta con maniglia frontale
door with front handle

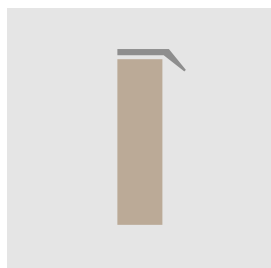

IN TESTA
anta con maniglia in testa
door with top mounted handle

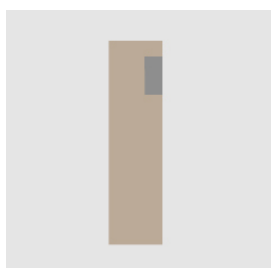

INCASSATA
anta con maniglia incassata
door with built-in handle



Impiallacciato

SP. 22 MM

Neck cod. **N01**

Lux cod. **L01**

Bridge cod. **B01**

CARATTERISTICHE TECNICHE

ANTE E FRONTALI CASSETTI

anta sp.22 mm impiallacciata **rovere laccato a poro aperto opaco** fiamma orizzontale con bordo in massello di rovere 10/10 sui 4 lati vena longitudinale nei colori: rovere bianco (opz.5415), rovere sahara (opz.5416), rovere visone (opz.5417), rovere grigio cenere (opz.5418), rovere lavagna (opz.5419), rovere nero (opz.5420)

anta sp.22 mm impiallacciata **rovere spazzolata materica** fiamma verticale con nodo, bordo in massello di rovere 10/10 sui 4 lati, di cui 2 lati in larghezza vena trasversale e 2 lati in altezza vena longitudinale nei colori: rovere grigio nebbia (opz.5401), rovere polvere (opz.5402), rovere grafite (opz.5403), rovere naturale (opz.5404), rovere tabacco (opz.5405)

anta sp.22 mm impiallacciata **senza nodo poro semiaperto** fiamma verticale con bordo in massello di rovere 10/10 sui 4 lati in larghezza vena longitudinale nei colori: rovere termocotto (opz.5410), noce canaletto (opz.1324)

GOLE E PROFILI

vedi pag.36-37

MANIGLIE

vedi pag.46-55

STRUTTURE

ANTA: rovere bianco

di serie : nobilitato bianco (opz.001) schiena e ripiano bianco (opz.001)

ANTE: rovere naturale, rovere grigio nebbia, noce canaletto, rovere sahara, rovere visone

di serie : nobilitato visone (opz.948M) schiena e ripiano visone (opz.948M)

ANTE: rovere grafite, rovere polvere, rovere lavagna, rovere grigio cenere, rovere nero

di serie : nobilitato lavagna (opz.9620) schiena e ripiano lavagna (opz.9620)

ANTE: rovere tabacco, rovere termocotto

di serie : nobilitato fango (opz.8860) schiena e ripiano fango (opz.8860)

a richiesta : nobilitato perla d'oriente (opz.940) schiena e ripiano bianco (opz.001)

nobilitato devalè finitura grafis (opz.796) schiena e ripiano bianco (opz.001)



MENSOLE

vedi pag.56

ZOCCOLI

vedi pag.57



Veneered

TH. 22 MM

Neck cod. **N01**

Lux cod. **L01**

Bridge cod. **B01**

TECHNICAL FEATURES

DOORS AND DRAWER FRONTS

22 mm th. veneered door **open-pore matt lacquered oak with horizontal grain** and 10/10 solid oak edging (lengthwise grain) on the 4 sides, available in the following colours: white oak (opt.5415), sahara oak (opt.5416), mink oak (opt.5417), ash grey oak (opt.5418), slate grey oak (opt.5419), black oak (opt.5420)

22 mm th. veneered **brushed door in oak with knots and vertical grain textured finish**, with 10/10 solid oak edge on the 4 sides, of which 2 upright sides with lengthwise grain and 2 horizontal sides with transverse grain, available in the following colours: mist grey oak (opt.5401), dust oak (opt.5402), graphite oak (opt.5403), natural oak (opt.5404), tobacco oak (opt.5405)

22 mm th. veneered door **semi open-pore vertical grain without knots**, with 10/10 solid oak edging (lengthwise grain) on the 4 sides, available in the following colours: thermo-treated oak (opt.5410), canaletto walnut (opt.1324)

FINGER RAILS AND PROFILES

[see page 36-37](#)

HANDLES

[see page 46-55](#)

STRUCTURES

DOOR: white oak

standard: melamine-coated white (opt.001), white back panel and shelf (opt.001)

DOORS: natural oak, mist grey oak, canaletto walnut, sahara oak, mink oak

standard: melamine-coated mink (opt.948M), mink back panel and shelf (opt.948M)

DOORS: graphite oak, dust oak, slate grey oak, ash grey oak, black oak

standard: melamine-coated slate grey (opt.9620), slate grey back panel and shelf (opt.9620)

DOORS: tobacco oak, thermo-treated oak

standard: melamine-coated mud (opt.8860), mud back panel and shelf (opt.8860)

on request: melamine-coated oriental pearl (opt.940), white back panel and shelf (opt.001)

melamine-coated devalè with grafis finish (opt.796), white back panel and shelf (opt.001)

SHELVES

[see page 56](#)

PLINTHS

[see page 57](#)

Impiallacciato **V**eneered

SP. 22 MM TH. 22 MM

ante rovere laccato a poro aperto opaco
door in open-pore matt lacquered oak

Neck cod.

Lux cod. **L01**

Bridge cod. **B01**



rovere bianco (opz.5415)
fiamma orizzontale
white oak (opt.5415),
horizontal grain



rovere sahara (opz.5416)
fiamma orizzontale
sahara oak (opt.5416),
horizontal grain



rovere visone (opz.5417)
fiamma orizzontale
mink oak (opt.5417),
horizontal grain



rovere grigio cenere (opz.5418)
fiamma orizzontale
ash grey oak (opt.5418),
horizontal grain



rovere lavagna (opz.5419)
fiamma orizzontale
slate grey oak (opt.5419),
horizontal grain



rovere nero (opz.5420)
fiamma orizzontale
black oak (opt.5420),
horizontal grain

ante rovere spazzolate materiche con nodo
brushed door in oak with knots textured finish



rovere grigio nebbia (opz.5401)
fiamma verticale
mist grey oak (opt.5401),
vertical grain



rovere polvere (opz.5402)
fiamma verticale
dust oak (opt.5402),
vertical grain



rovere grafite (opz.5403)
fiamma verticale
graphite oak (opt.5403),
vertical grain



rovere naturale (opz.5404)
fiamma verticale
natural oak (opt.5404),
vertical grain



rovere tabacco (opz.5405)
fiamma verticale
tobacco oak (opt.5405),
vertical grain

Impiallacciato **V**eneered

SP. 22 MM TH. 22 MM

ante rovere spazzolate materiche
brushed door in oak textured finish



rovere tan (opz.5408)
fiamma verticale, senza nodo
tan oak (opt.5408),
vertical grain, without knots



rovere cenere (opz.5409)
fiamma verticale, senza nodo
ash oak (opt.5409),
vertical grain, without knots

SP. 22 MM TH. 22 MM

ante poro semiaperto senza nodo
semi-open pore door without knots



rovere termocotto (opz.5410)
fiamma verticale
thermo-treated oak
(opt.5410), vertical grain



noce canaletto (opz.1324)
fiamma verticale
canaletto walnut (opt.1324),
vertical grain

Neck cod. **N01**

Lux cod. **L01**

Bridge cod. **B01**

Neck cod. **N01**

Lux cod. **L01**

Bridge cod. **B01**

Neck



particolare anta squadrata
squared edge door detail

Lux

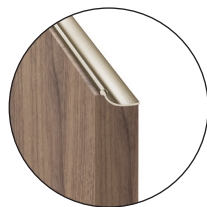

particolare anta profilo curvo
door with curved profile detail

Bridge



particolare anta profilo ad "ELLE"
door with "ELLE" shaped profile detail

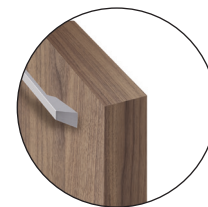

particolare anta squadrata
con maniglia
squared edge door detail
with handle

Malta Laccato Opaco Matt Lacquered Mortar Finish

SP. 22 MM TH. 22 MM

Neck cod. **N02**
Lux cod. **L02**
Bridge cod. **B02**

CARATTERISTICHE TECNICHE

ANTE E FRONTALI CASSETTI

anta sp.22 mm in mdf con fondo cemento laccata finitura pigmentata acrilica antigraffio nei colori opachi:
white (opz.LM11), mink (opz.LM15), dark grey (opz.LM12), light grey (opz.LM14), blackboard (opz.LM13)

GOLE E PROFILI

vedi pag.36-37

MANIGLIE

vedi pag.46-55

STRUTTURE

ANTA: white
di serie : nobilitato bianco (opz.001) schiena e ripiano bianco (opz.001)
ANTE: light grey, black board
di serie : nobilitato lavagna (opz.9620) schiena e ripiano lavagna (opz.9620)
ANTE: mink, dark grey
di serie : nobilitato visone (opz.948M) schiena e ripiano visone (opz.948M)

a richiesta : nobilitato perla d'oriente (opz.940) schiena e ripiano bianco (opz.001)
nobilitato devalè finitura grafis (opz.796) schiena e ripiano bianco (opz.001)
nobilitato fango (opz.8860) schiena e ripiano fango (opz.8860)



MENSOLE

vedi pag.56

ZOCCOLI

vedi pag.57

TECHNICAL FEATURES

DOORS AND DRAWER FRONTS

Th. 22 mm mdf lacquered door with cement surface anti-finger print acrylic pigmented finish in the following matt colours:
white (opt.LM11), mink (opt.LM15), dark grey (opt.LM12), light grey (opt.LM14), blackboard (opt.LM13)

FINGER RAILS AND PROFILES

see page 36-37

HANDLES

see page 46-55

STRUCTURES

DOOR: white
standard: melamine-coated white (opt.001), white back panel and shelf (opt.001)
DOORS: light grey, black board
standard: melamine-coated slate grey (opt.9620), slate grey back panel and shelf (opt.9620)
DOORS: mink, dark grey
standard: melamine-coated mink (opt. 948M), mink back panel and shelf (opt.948M)

on request: melamine-coated oriental pearl (opt.940), white back panel and shelf (opt.001)
melamine-coated devalè with grafis finish (opt.796), white back panel and shelf (opt.001)
melamine-coated mud (opt.8860), mud back panel and shelf (opt.8860)

SHELVES

see page 56

PLINTHS

see page 57



Malta Laccato Opaco

Matt Lacquered Mortar Finish

SP. 22 MM TH. 22 MM

ante laccate con fondo cemento
lacquered doors with cement surface



white (opz.LM11)
white (opt.LM11)



mink (opz.LM15)
mink (opt.LM15)



dark grey (opz.LM12)
dark grey (opt.LM12)



light grey (opz.LM14)
light grey (opt.LM14)



blackboard (opz.LM13)
blackboard (opt.LM13)



particolare anta
door detail

Neck cod. **N02**
Lux cod. **L02**
Bridge cod. **B02**

Neck

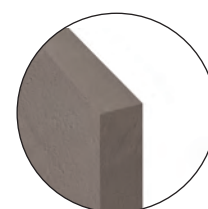

particolare anta squadrata
squared edge door detail

Lux

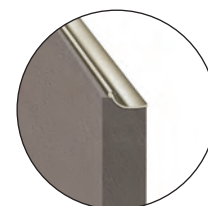

particolare anta profilo curvo
door with curved profile detail

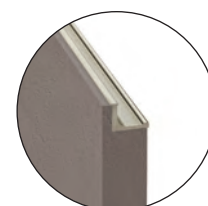

particolare anta profilo ad "ELLE"
door with "ELLE" shaped profile detail

Bridge

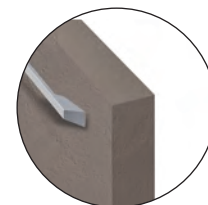

particolare anta squadrata
con maniglia
squared edge door detail
with handle

Laccato Opaco

Matt Lacquered

SP. 22 MM TH. 22 MM

Neck cod. N03
Lux cod. L03
Bridge cod. B03

CARATTERISTICHE TECNICHE

ANTE E FRONTALI CASSETTI

anta sp.22 mm in mdf laccata **finitura opaca soft nei colori:**

[CLICCA QUI PER LA GAMMA COLORI DISPONIBILI](#)

[CLICK HERE FOR THE RANGE OF AVAILABLE COLORS](#)

GOLE E PROFILI

vedi pag.36-37

MANIGLIE

vedi pag.46-55

STRUTTURE

di serie: nobilitato bianco (opz.001) schiena e ripiano bianco (opz.001)

a richiesta: nobilitato visone (opz.948M) schiena e ripiano visone (opz.948M)
nobilitato lavagna (opz.9620) schiena e ripiano lavagna (opz.9620)
nobilitato devalè finitura grafis (opz.796) schiena e ripiano bianco (opz.001)
nobilitato perla d'oriente (opz.940) schiena e ripiano bianco (opz.001)
nobilitato fango (opz.8860) schiena e ripiano fango (opz.8860)



MENSOLE

vedi pag.56

ZOCCOLI

vedi pag.57

TECHNICAL FEATURES

DOORS AND DRAWER FRONTS

22 mm th. MDF door, with **soft matt lacquered finish in the following colours:**

FINGER RAILS AND PROFILES

see page 36-37

HANDLES

see page 46-55

STRUCTURES

standard: melamine-coated white (opt.001), white back panel and shelf (opt.001)

on request: melamine-coated mink (opt.948M), mink back panel and shelf (opt.948M)
melamine-coated slate grey (opt.9620), slate grey back panel and shelf (opt.9620)
melamine-coated devalè with grafis finish (opt.796), white back panel and shelf (opt.001)
melamine-coated oriental pearl (opt.940), white back panel and shelf (opt.001)
melamine-coated mud (opt.8860), mud back panel and shelf (opt.8860)

SHELVES

see page 56

PLINTHS

see page 57



Laccato Lucido Spazzolato
Brushed Glossy Lacquered

SP. 22 MM TH. 22 MM

Neck cod. N04
Lux cod. L04
Bridge cod. B04

CARATTERISTICHE TECNICHE

ANTE E FRONTALI
CASSETTI

anta sp.22 mm in mdf laccata **finitura lucida spazzolata nei colori:**

[CLICCA QUI PER LA GAMMA COLORI DISPONIBILI](#)

[CLICK HERE FOR THE RANGE OF AVAILABLE COLORS](#)

GOLE E PROFILI

[vedi pag.36-37](#)

MANIGLIE

[vedi pag.46-55](#)

STRUTTURE

di serie: nobilitato bianco (opz.001) schiena e ripiano bianco (opz.001)

a richiesta: nobilitato visone (opz.948M) schiena e ripiano visone (opz.948M)
nobilitato lavagna (opz.9620) schiena e ripiano lavagna (opz.9620)
nobilitato devalè finitura grafis (opz.796) schiena e ripiano bianco (opz.001)
nobilitato perla d'oriente (opz.940) schiena e ripiano bianco (opz.001)
nobilitato fango (opz.8860) schiena e ripiano fango (opz.8860)



MENSOLE

[vedi pag.56](#)

ZOCCOLI

[vedi pag.57](#)

TECHNICAL FEATURES

DOORS AND
DRAWER FRONTS

22 mm th. MDF door, with **brushed glossy lacquered finish in the following colours:**

FINGER RAILS
AND PROFILES

[see page 36-37](#)

HANDLES

[see page 46-55](#)

STRUCTURES

standard: melamine-coated white (opt.001), white back panel and shelf (opt.001)

on request: melamine-coated mink (opt.948M), mink back panel and shelf (opt.948M)
melamine-coated slate grey (opt.9620), slate grey back panel and shelf (opt.9620)
melamine-coated devalè with grafis finish (opt.796), white back panel and shelf (opt.001)
melamine-coated oriental pearl (opt.940), white back panel and shelf (opt.001)
melamine-coated mud (opt.8860), mud back panel and shelf (opt.8860)

SHELVES

[see page 56](#)

PLINTHS

[see page 57](#)



Laccato Opaco

Matt Lacquered

SP. 22 MM TH. 22 MM

Neck cod. **N03**

Lux cod. **L03**

Bridge cod. **B03**

Neck

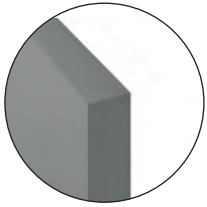

particolare anta squadrata
squared edge door detail

Lux

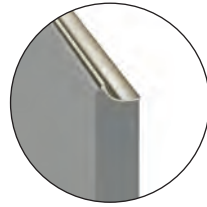

particolare anta profilo curvo
door with curved profile detail

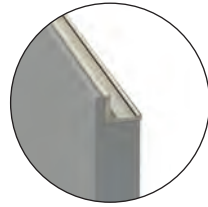

particolare anta profilo ad "ELLE"
door with "ELLE" shaped profile detail

Bridge

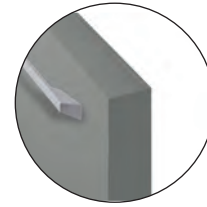

particolare anta squadrata
con maniglia
squared edge door detail
with handle

Laccato **L**ucido **S**pazzolato
Brushed **G**lossy **L**acquered

SP. 22 MM TH. 22 MM

Neck cod. **N04**

Lux cod. **L04**

Bridge cod. **B04**

Neck

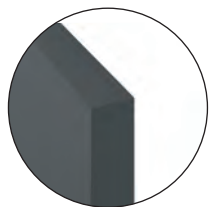

particolare anta squadrata
squared edge door detail

Lux

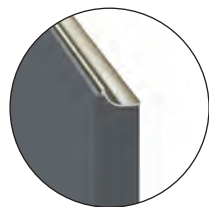

particolare anta profilo curvo
door with curved profile detail

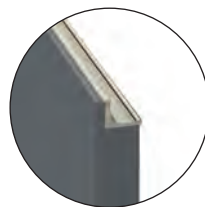

particolare anta profilo ad "ELLE"
door with "ELLE" shaped profile detail

Bridge

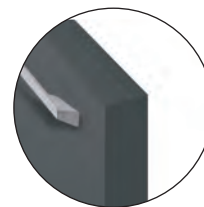

particolare anta squadrata
con maniglia
squared edge door detail
with handle

Laccato Vintage Vintage Lacquered

SP. 22 MM TH. 22 MM

Neck cod. **N04**
Lux cod. **L04**
Bridge cod. **B04**

CARATTERISTICHE TECNICHE

ANTE E FRONTALI CASSETTI anta sp.22 mm in mdf laccata **finitura semilucida effetto metallo vintage** nei colori: peltro (opz.9549), ferro (opz.9506), urban (opz.7894), bronzo (opz.8904)

GOLE E PROFILI [vedi pag.36-37](#)

MANIGLIE [vedi pag.46-55](#)

STRUTTURE
ANTE: peltro, ferro, urban
di serie: nobilitato lavagna (opz.9620) schiena e ripiano lavagna (opz.9620)
ANTA: bronzo
di serie: nobilitato fango (opz.8860) schiena e ripiano fango (opz.8860)

a richiesta: nobilitato visone (opz.948M) schiena e ripiano visone (opz.948M)
nobilitato bianco (opz.001) schiena e ripiano bianco (opz.001)
nobilitato devalè finitura grafis (opz.796) schiena e ripiano bianco (opz.001)
nobilitato perla d'oriente (opz.940) schiena e ripiano bianco (opz.001)



MENSOLE [vedi pag.56](#)

ZOCCOLI [vedi pag.57](#)

TECHNICAL FEATURES

DOORS AND DRAWER FRONTS 22 mm th. door in mdf with **vintage metal effect semi-gloss lacquered finish** in the following colours: pewter (opt.9549), iron (opt.9506), urban (opt.7894), bronze (opt.8904)

FINGER RAILS AND PROFILES [see page 36-37](#)

HANDLES [see page 46-55](#)

STRUCTURES
DOORS: pewter, iron, urban
standard: melamine-coated slate grey (opt.9620), slate grey back panel and shelf (opt.9620)
DOOR: bronze
standard: melamine-coated mud (opt.8860), mud back back panel and shelf (opt.8860)

on request: melamine-coated mink (opt.948M), mink back panel and shelf (opt.948M)
melamine-coated white (opt.001), white back panel and shelf (opt.001)
melamine-coated devalè with grafis finish (opt.796), white back panel and shelf (opt.001)
melamine-coated oriental pearl (opt.940), white back panel and shelf (opt.001)

SHELVES [see page 56](#)

PLINTHS [see page 57](#)



Laccato Vintage Vintage Lacquered

SP. 22 MM TH. 22 MM

ante laccate vintage effetto metallo
lacquered vintage doors metal effect



anta peltro (opz.9549)
pewter door (opt.9549)



anta ferro (opz.9506)
iron door (opt.9506)



anta urban (opz.7894)
urban door (opt.7894)



anta bronzo (opz.8904)
bronze door (opt.8904)

Neck cod. **N04**
Lux cod. **L04**
Bridge cod. **B04**

Neck

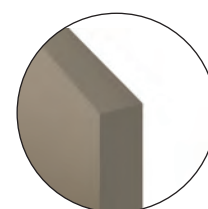

particolare anta squadrata
squared edge door detail

Lux

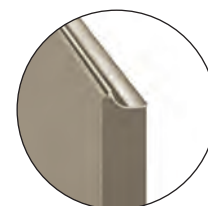

particolare anta profilo curvo
door with curved profile detail



particolare anta profilo ad "ELLE"
door with "ELLE" shaped profile detail

Bridge



particolare anta squadrata
con maniglia
squared edge door detail
with handle

Laccato Vintage Vintage Lacquered

SP. 22 MM TH. 22 MM

Neck cod. **N04**
Lux cod. **L04**
Bridge cod. **B04**

CARATTERISTICHE TECNICHE

ANTE E FRONTALI CASSETTI

anta sp.22 mm in mdf laccata **finitura semilucida effetto metallo vintage spazzolato** nei colori:
bronzo anticato (opz.8909), rame anticato (opz.8159), nichel (opz.9505), bronzo brunito (opz.8903), grafite (opz.9508)

GOLE E PROFILI

vedi pag.10-11

MANIGLIE

vedi pag.12

STRUTTURE

ANTE: rame anticato, bronzo brunito, bronzo anticato
di serie: nobilitato fango (opz.8860) schiena e ripiano fango (opz.8860)
ANTE: grafite
di serie: nobilitato lavagna (opz.9620) schiena e ripiano lavagna (opz.9620)
ANTA: nichel
di serie: nobilitato visone (opz.948M) schiena e ripiano visone (opz.948M)



MENSOLE

vedi pag.14

ZOCCOLI

vedi pag.15

TECHNICAL FEATURES

DOORS AND DRAWER FRONTS

22 mm th. door in mdf with **vintage metal effect semi-gloss lacquer brushed finish** in the following colours:
antique bronze (opt. 8909), antique copper (opt. 8159), nickel (opt. 9505), burnished bronze (opt. 8903), graphite (opt. 9508)

FINGER RAILS AND PROFILES

see page 10-11

HANDLES

see page 12

STRUCTURES

DOORS: antique copper, burnished bronze, antique bronze
standard: melamine-coated mud (opt.8860), mud back panel and shelf (opt.8860)
DOORS: graphite
standard: melamine-coated slate grey (opt.9620), slate grey back panel and shelf (opt.9620)
DOOR: nickel
standard: melamine-coated mink (opt.948M), mink back panel and shelf (opt.948M)

SHELVES

see page 14

PLINTHS

see page 15



Laccato Vintage Vintage Lacquered

SP. 22 MM TH. 22 MM

ante laccate vintage effetto metallo
lacquered vintage doors metal effect



bronzo brunito (opz.8903)
burnished bronze (opt.8903)



grafite (opz.9508)
graphite (opt.9508)



nicel (opz.9505)
nickel (opt.9505)



bronzo anticato (opz.8909)
antique bronze (opt.8909)



rame anticato (opz.8159)
antique copper (opt.8159)

Neck cod. **N04**
Lux cod. **L04**
Bridge cod. **B04**

Neck

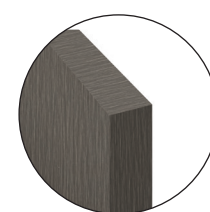

particolare anta squadrata
squared edge door detail

Lux

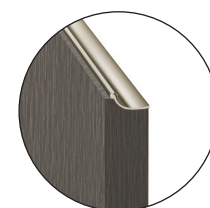

particolare anta profilo curvo
door with curved profile detail

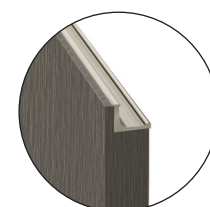

particolare anta profilo ad "ELLE"
door with "ELLE" shaped profile detail

Bridge

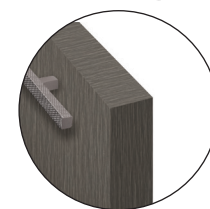

particolare anta squadrata
con maniglia
squared edge door detail
with handle

Dune Laccato Opaco

"Dunes" Matt Lacquered

SP. 22 MM TH. 22 MM

Neck cod. **N05**
Bridge cod. **B05**

CARATTERISTICHE TECNICHE

ANTE E FRONTALI
CASSETTI

anta sp.22 mm in mdf pantografata in bassorilievo **laccata finitura opaca soft nei colori:**

[CLICCA QUI PER LA GAMMA COLORI DISPONIBILI](#)

[CLICK HERE FOR THE RANGE OF AVAILABLE COLORS](#)

GOLE

vedi pag.36-37

MANIGLIE

senza maniglia apertura push-pull

STRUTTURE

di serie: nobilitato bianco (opz.001) schiena e ripiano bianco (opz.001)

a richiesta: nobilitato visone (opz.948M) schiena e ripiano visone (opz.948M)
nobilitato lavagna (opz.9620) schiena e ripiano lavagna (opz.9620)
nobilitato devalè finitura grafis (opz.796) schiena e ripiano bianco (opz.001)
nobilitato perla d'oriente (opz.940) schiena e ripiano bianco (opz.001)
nobilitato fango (opz.8860) schiena e ripiano fango (opz.8860)



MENSOLE

vedi pag.56

ZOCCOLI

vedi pag.57

TECHNICAL FEATURES

DOORS AND
DRAWER FRONTS

22 mm th. MDF door low relief pantographed, with **soft matt lacquered finish in the following colours:**

FINGER RAIL

see page 36-37

HANDLES

without handle, push-pull opening

STRUCTURES

standard: melamine-coated white (opt.001), white back panel and shelf (opt.001)

on request: melamine-coated mink (opt.948M), mink back panel and shelf (opt.948M)
melamine-coated slate grey (opt.9620), slate grey back panel and shelf (opt.9620)
melamine-coated devalè with grafis finish (opt.796), white back panel and shelf (opt.001)
melamine-coated oriental pearl (opt.940), white back panel and shelf (opt.001)
melamine-coated mud (opt.8860), mud back panel and shelf (opt.8860)

SHELVES

see page 56

PLINTHS

see page 57



Dune Laccato Opaco

"Dunes" Matt Lacquered

SP. 22 MM TH. 22 MM

ante dune laccate opache

matt lacquered dunes doors



Neck cod. **N05**

Bridge cod. **B05**

Neck-Bridge

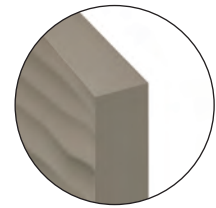

particolare anta squadrata
squared edge door detail

SP. 22 MM TH. 22 MM

Neck cod. **N06**
Lux cod. **L06**
Bridge cod. **B06**

CARATTERISTICHE TECNICHE

ANTE E FRONTALI CASSETTI telaio alluminio verniciato a polvere finitura opaca tamburata nella parte posteriore con pannello HDF grigio cenere e frontale in gres laminam sp.3 mm nei colori: gres avorio blend (opz.G40C), gres nero blend (opz.G43B), gres terra fokos (opz.G71C), gres sale fokos (opz.G70F), gres pietra di savoia naturale (opz.G73A)

GOLE vedi pag.36-37

MANIGLIE maniglia incorporata all'anta

STRUTTURE
ANTE: gres avorio blend, gres terra fokos
di serie : nobilitato fango (opz.8860) schiena e ripiano fango (opz.8860)
ANTE: gres nero blend, gres pietra di savoia naturale
di serie : nobilitato lavagna (opz.9620) schiena e ripiano lavagna (opz.9620)
ANTA: gres sale fokos
di serie : nobilitato visone (opz.948M) schiena e ripiano visone (opz.948M)

a richiesta : nobilitato perla d'oriente (opz.940) schiena e ripiano bianco (opz.001)
nobilitato devalè finitura grafis (opz.796) schiena e ripiano bianco (opz.001)
nobilitato bianco (opz.001) schiena e ripiano bianco (opz.001)



MENSOLE vedi pag.56

ZOCCOLI vedi pag.57

TECHNICAL FEATURES

DOORS AND DRAWER FRONTS Aluminium frame dust painted matt finish, hollow-core back with a HDF panel ash grey colour and th.3 mm gres laminam front in the colours: ivory gres blend (opt.G40C), black gres blend (opt.G43B), earth gres fokos (opt.G71C), sale gres fokos (opt.G70F), pietra di Savoia gres naturale (opt.G73A)

FINGER RAILS see page 36-37

HANDLES built-in door handle

STRUCTURES
DOORS: ivory gres blend, earth gres fokos
standard: melamine-coated mud (opt.8860), mud back panel and shelf (opt.8860)
DOORS: black gres blend, pietra di Savoia gres naturale
standard: melamine-coated slate grey (opt.9620), slate grey back panel and shelf (opt.9620)
DOOR: sale gres fokos
standard: melamine-coated mink (opt.948M), mink back panel and shelf (opt.948M)

on request: melamine-coated oriental pearl (opt.940), white back panel and shelf (opt.001)
melamine-coated devalè with grafis finish (opt.796), white back panel and shelf (opt.001)
melamine-coated white (opt.001), white back panel and shelf (opt.001)

SHELVES see page 56

PLINTHS see page 57



CARATTERISTICHE TECNICHE

GRES LAMINAM

è un prodotto in gres porcellanato ottenuto con tecnologia innovativa attraverso la compattazione del materiale e la successiva cottura in forno elettrico a temperature superiori a 1220°C circa, appositamente studiato per garantire l'uniformità del prodotto. Le principali caratteristiche sono:

is a product developed using innovative technology which compacts the material and increases precision. Natural materials such as quarried clay, granite rocks and ceramic pigments are wet worked and then hybrid-cooked in an electric oven at temperatures above 1220 °C to guarantee solidity. The main features are:



RESISTENZA AGLI ATTACCHI CHIMICI

LAMINAM resiste ai solventi organici, inorganici, disinfettanti e detergenti. Si pulisce con estrema facilità mantenendo inalterate le caratteristiche della superficie; l'unico prodotto in grado di attaccare il prodotto è l'acido fluoridrico.

CHEMICAL RESISTANT

Laminam resists to organic and inorganic solvents, disinfectants and detergents. It can be easily cleaned without affecting its surface characteristics; the only product that can attack the slabs is hydrofluoric acid.



RESISTENZA ALL'USURA

LAMINAM resiste ai graffi e all'abrasione profonda. Le sue proprietà rimangono pertanto inalterate anche dopo un uso intensivo e una pulizia frequente.

WEAR RESISTANT

Laminam is highly scratchproof and resistant to deep abrasion. The properties of the slabs remain unchanged even after intensive use and frequent cleaning.



ELEVATA RESISTENZA ALLA FLESSIONE

LAMINAM presenta un elevato modulo di rottura.

HIGH FLEXURAL STRENGTH

Laminam has a high modulus of rupture.



REAZIONE AL FUOCO

LAMINAM non contiene materie organiche, pertanto, resiste al fuoco e alle alte temperature.

In caso d'incendio non sprigiona fumo e non emette sostanze tossiche.

FIRE RESISTANT

Laminam does not contain organic material therefore it is resistant to fire and high temperatures. In the event of fire it does not release smoke or toxic substances.



SUPERFICIE IGIENICA

LAMINAM è totalmente compatibile con le sostanze alimentari in quanto non rilascia elementi in soluzione.

Non consente l'insorgenza di muffe, batteri e funghi.

HYGIENIC SURFACE

Laminam is perfectly suitable for food substances since it does not release elements in solution. It does not allow the formation of mould, bacteria and fungi.



PROPRIETÀ CROMATICHE

Priva di pigmenti organici, LAMINAM resiste ai raggi UV. I colori non subiscono alcuna alterazione, anche se sottoposti a variazioni delle condizioni climatiche.

CHROMATIC PROPERTIES

Laminam does not contain organic pigments and is resistant to UV rays. Even if subjected to severe climate changes, the colours remain stable.



ECO-COMPATIBILITÀ E RICICLABILITÀ

LAMINAM è un prodotto totalmente naturale. Non cede elementi all'ambiente e può essere facilmente macinato e interamente riciclato in altri processi produttivi.

ECO-FRIENDLY AND RECYCLABLE

Laminam is a totally natural product. It does not release any elements into the environment and can be easily milled and recycled in other manufacturing processes.



ANTIGRAFFITI

LAMINAM è la prima superficie ceramica antigraffiti, si pulisce facilmente e non viene intaccato nemmeno dalle vernici più tenaci.

GRAFFITI PROOF

Laminam is the first graffiti proof ceramic surface; it is easy to clean and even the strongest paints can be easily removed.)

Gres Laminam

SP. 22 MM TH. 22 MM

Neck cod. **N06**
Lux cod. **L06**
Bridge cod. **B06**

ante gres laminam
gres laminam doors



gres avorio blend
telaio alluminio
laccato opaco castoro

ivory blend gres,
beaver matt lacquered
aluminium frame

Neck - Bridge (opz.G40C)
Lux curvo (opz.CG40C)
Lux "ELLE" (opz.LG40C)



gres nero blend
telaio alluminio
laccato opaco bistro

black blend gres,
bistro matt lacquered
aluminium frame

Neck - Bridge (opz.G43B)
Lux curvo (opz.CG43B)
Lux "ELLE" (opz.LG43B)



gres terra fokos
telaio alluminio
laccato opaco castoro

earth fokos gres,
beaver matt lacquered
aluminium frame

Neck - Bridge (opz.G71C)
Lux curvo (opz.CG71C)
Lux "ELLE" (opz.LG71C)



gres sale fokos
telaio alluminio
laccato opaco fumo

sale fokos gres,
smoke matt lacquered
aluminium frame

Neck - Bridge (opz.G70F)
Lux curvo (opz.CG70F)
Lux "ELLE" (opz.LG70F)



gres pietra di Savoia naturale
telaio alluminio
laccato opaco argilla

pietra di Savoia naturale gres,
clay matt lacquered
aluminium frame

Neck - Bridge (opz.G73A)
Lux curvo (opz.CG73A)
Lux "ELLE" (opz.LG73A)



particolare retro anta grigio cenere
detail of the back side of the door,
ash grey colour

Neck

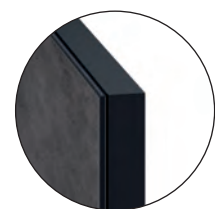

particolare anta squadrata
squared edge door detail

Lux

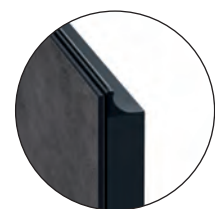

particolare anta profilo curvo
door with curved profile detail

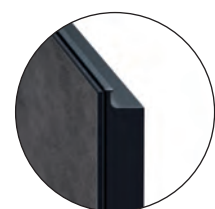

particolare anta profilo ad "ELLE"
door with "ELLE" shaped profile detail

Bridge



particolare maniglia
detail frame with handle

SP. 22 MM TH. 22 MM

Neck cod. **N06**
Lux cod. **L06**
Bridge cod. **B06**

CARATTERISTICHE TECNICHE

ANTE E FRONTALI CASSETTI telaio alluminio verniciato a polvere finitura opaca tamburata nella parte posteriore con pannello HDF grigio cenere e frontale in gres laminam sp.3 mm nei colori: statuario (opz.G50H), noir desir (opz.G75B)

GOLE vedi pag.10-11

MANIGLIE maniglia incorporata all'anta

STRUTTURE

ANTA: noir desir
di serie : nobilitato lavagna (opz.9620) schiena e ripiano lavagna (opz.9620)
ANTA: statuario
di serie : nobilitato conchiglia (opz.8910) schiena e ripiano conchiglia (opz.8910)



MENSOLE vedi pag.14

ZOCCOLI vedi pag.15

TECHNICAL FEATURES

DOORS AND DRAWER FRONTS Aluminium frame dust painted matt finish, hollow-core back with a HDF panel ash grey colour and th.3 mm gres laminam front in the colours: statuesque (opt.G50H), desir noir (opt.G75B)

FINGER RAILS see page 10-11

HANDLES built-in door handle

STRUCTURES

DOOR: desir noir
standard: melamine-coated slate grey (opt.9620), slate grey back panel and shelf (opt.9620)
DOOR: statuesque
standard: melamine-coated shell (opt.8910), shell back panel and shelf (opt.8910)

SHELVES see page 14

PLINTHS see page 15



Gres Laminam

SP. 22 MM TH. 22 MM

Neck cod. **N06**

Lux cod. **L06**

Bridge cod. **B06**

ante gres laminam
gres laminam doors



gres statuaria
telaio alluminio
laccato opaco conchiglia

statuesque gres,
shell matt lacquered
aluminium frame

Neck - Bridge (opz.G50H)
Lux curvo (opz.CG50H)
Lux "ELLE" (opz.LG50H)

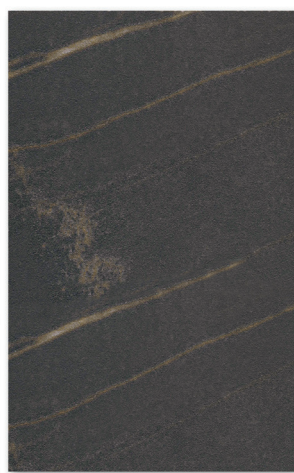

gres noir desir
telaio alluminio
laccato opaco bistro

desir noir gres,
bistro matt lacquered
aluminium frame

Neck - Bridge (opz.G75B)
Lux curvo (opz.CG75B)
Lux "ELLE" (opz.LG75B)

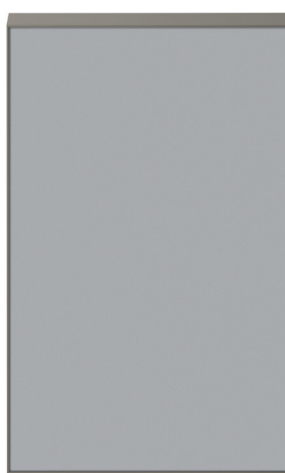

particolare retro anta grigio cenere
detail of the back side of the door,
ash grey colour



Vetro Satinato Verniciato

Painted Satin Glass

SP. 22 MM TH. 22 MM

Neck cod. **N07**
Lux cod. **L07**
Bridge cod. **B07**

CARATTERISTICHE TECNICHE

ANTE E FRONTALI CASSETTI

telaio alluminio sp.22 mm verniciato a polvere finitura opaca in tinta con il vetro, tamburato nella parte posteriore con pannello in HDF grigio cenere sp.3 mm.

Vetro temperato satinato sp.4 mm laccato nei colori **freddi**:
bianco assoluto, cenere, grigio bromo, nero

Vetro temperato satinato sp.4 mm laccato nei colori **caldi**:
bianco caldo, canapa, castoro, fumo, verde lichene, bistro, rosso toscano, giallo ambra, grigio piombo, verde positano, bronzo

GOLE

vedi pag.36-37

MANIGLIE

maniglia incorporata all'anta

STRUTTURE

di serie: nobilitato bianco (opz.001) schiena e ripiano bianco (opz.001)

a richiesta: nobilitato visone (opz.948M) schiena e ripiano visone (opz.948M)
nobilitato lavagna (opz.9620) schiena e ripiano lavagna (opz.9620)
nobilitato devalè finitura grafis (opz.796) schiena e ripiano bianco (opz.001)
nobilitato perla d'oriente (opz.940) schiena e ripiano bianco (opz.001)
nobilitato fango (opz.8860) schiena e ripiano fango (opz.8860)



MENSOLE

vedi pag.56

ZOCCOLI

vedi pag.57

TECHNICAL FEATURES

DOORS AND DRAWER FRONTS

Aluminium frame Th.22 mm dust painted with matt finish matching with the glass and back coated with a HDF panel ash grey colour

Hardened satin glass, lacquered in the following **cold** colours:
absolute white, ash, bromine grey, black

Hardened satin glass, lacquered in the following **warm** colours:
warm white, hemp, beaver, smoke, lichen green, bistro, tuscan red, amber yellow, lead grey, positano green, bronze

FINGER RAILS

see page 36-37

HANDLES

built-in door handle

STRUCTURES

standard: melamine-coated white (opt.001), white back panel and shelf (opt.001)

on request: melamine-coated mink (opt.948M), mink back panel and shelf (opt.948M)
melamine-coated slate grey (opt.9620), slate grey back panel and shelf (opt.9620)
melamine-coated devalè with grafis finish (opt.796), white back panel and shelf (opt.001)
melamine-coated oriental pearl (opt.940), white back panel and shelf (opt.001)
melamine-coated mud (opt.8860), mud back panel and shelf (opt.8860)

SHELVES

see page 56

PLINTHS

see page 57



Vetro Lucido Verniciato Painted Glossy Glass

SP. 22 MM TH. 22 MM

Neck cod. **N08**
Lux cod. **L08**
Bridge cod. **B08**

CARATTERISTICHE TECNICHE

ANTE E FRONTALI CASSETTI

telaio alluminio sp.22 mm verniciato a polvere finitura opaca in tinta con il vetro, tamburato nella parte posteriore con pannello in HDF grigio cenere sp.3 mm.

Vetro temperato lucido sp.4 mm laccato nei colori **freddi**:
bianco assoluto, cenere, grigio bromo, nero

Vetro temperato lucido sp.4 mm laccato nei colori **caldi**:
bianco caldo, canapa, castoro, fumo, verde lichene, bistro, rosso toscano, giallo ambra, grigio piombo, verde positano, bronzo

GOLE

vedi pag.36-37

MANIGLIE

maniglia incorporata all'anta

STRUTTURE

di serie: nobilitato bianco (opz.001) schiena e ripiano bianco (opz.001)

a richiesta: nobilitato visone (opz.948M) schiena e ripiano visone (opz.948M)
nobilitato lavagna (opz.9620) schiena e ripiano lavagna (opz.9620)
nobilitato devalè finitura grafis (opz.796) schiena e ripiano bianco (opz.001)
nobilitato perla d'oriente (opz.940) schiena e ripiano bianco (opz.001)
nobilitato fango (opz.8860) schiena e ripiano fango (opz.8860)



MENSOLE

vedi pag.56

ZOCCOLI

vedi pag.57

TECHNICAL FEATURES

DOORS AND DRAWER FRONTS

Aluminium frame Th.22 mm dust painted with matt finish matching with the glass and back coated with a HDF panel ash grey colour

Hardened glossy glass, lacquered in the following **cold** colours:
absolute white, ash, bromine grey, black

Hardened glossy glass, lacquered in the following **warm** colours:
warm white, hemp, beaver, smoke, lichen green, bistro, tuscan red, amber yellow, lead grey, positano green, bronze

FINGER RAILS

see page 36-37

HANDLES

built-in door handle

STRUCTURES

standard: melamine-coated white (opt.001), white back panel and shelf (opt.001)

on request: melamine-coated mink (opt.948M), mink back panel and shelf (opt.948M)
melamine-coated slate grey (opt.9620), slate grey back panel and shelf (opt.9620)
melamine-coated devalè with grafis finish (opt.796), white back panel and shelf (opt.001)
melamine-coated oriental pearl (opt.940), white back panel and shelf (opt.001)
melamine-coated mud (opt.8860), mud back panel and shelf (opt.8860)

SHELVES

see page 56

PLINTHS

see page 57



Vetro Satinato Verniciato

Painted Satin Glass

SP. 22 MM TH. 22 MM

anta vetro satinato
satin glass door

Neck cod. **N07**
Lux cod. **L07**
Bridge cod. **B07**



telaio alluminio, vetro fumo
aluminum frame, smoke glass



particolare retro anta grigio cenere
detail of the back side of the door,
ash grey colour

COLORI FREDDI SATINATI SATIN COLD COLOURS



bianco assoluto
satinato
satin absolute white

Neck-Bridge (opz.V740S)
Lux curvo (opz.C740S)
Lux "ELLE" (opz.L740S)

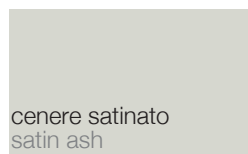

cenere satinato
satin ash

Neck-Bridge (opz.V9547)
Lux curvo (opz.C9547)
Lux "ELLE" (opz.L9547)

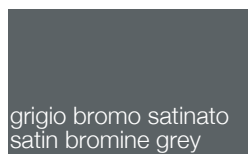

grigio bromo satinato
satin bromine grey

Neck-Bridge (opz.V9533)
Lux curvo (opz.C9533)
Lux "ELLE" (opz.L9533)

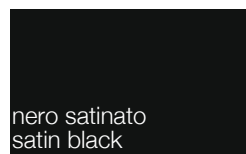

nero satinato
satin black

Neck-Bridge (opz.V7892)
Lux curvo (opz.C7892)
Lux "ELLE" (opz.L7892)

COLORI CALDI SATINATI SATIN WARM COLOURS



bianco caldo satinato
satin warm white

Neck-Bridge (opz.V7401)
Lux curvo (opz.C7401)
Lux "ELLE" (opz.L7401)



canapa satinato
satin hemp

Neck-Bridge (opz.V8531)
Lux curvo (opz.C8531)
Lux "ELLE" (opz.L8531)



castoro satinato
satin beaver

Neck-Bridge (opz.V8907)
Lux curvo (opz.C8907)
Lux "ELLE" (opz.L8907)

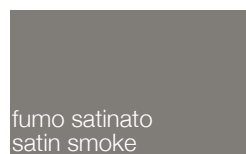

fumo satinato
satin smoke

Neck-Bridge (opz.V9531)
Lux curvo (opz.C9531)
Lux "ELLE" (opz.L9531)



verde lichene satinato
satin lichen green

Neck-Bridge (opz.V8463)
Lux curvo (opz.C8463)
Lux "ELLE" (opz.L8463)

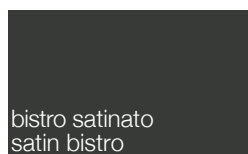

bistro satinato
satin bistro

Neck-Bridge (opz.V9535)
Lux curvo (opz.C9535)
Lux "ELLE" (opz.L9535)



rosso toscano satinato
satin tuscan red

Neck-Bridge (opz.V8157)
Lux curvo (opz.C8157)
Lux "ELLE" (opz.L8157)

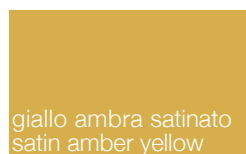

giallo ambra satinato
satin amber yellow

Neck-Bridge (opz.V327S)
Lux curvo (opz.C327S)
Lux "ELLE" (opz.L327S)

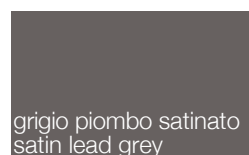

grigio piombo satinato
satin lead grey

Neck-Bridge (opz.V9537)
Lux curvo (opz.C9537)
Lux "ELLE" (opz.L9537)



verde positano satinato
satin positano green

Neck-Bridge (opz.V8471)
Lux curvo (opz.C8471)
Lux "ELLE" (opz.L8471)

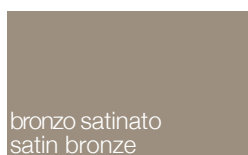

bronzo satinato
satin bronze

Neck-Bridge (opz.V8903)
Lux curvo (opz.C8903)
Lux "ELLE" (opz.L8903)

Neck

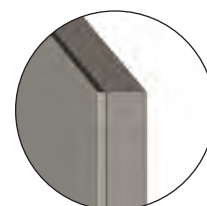

particolare anta squadrata
squared edge door detail

Lux

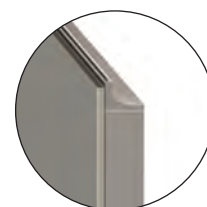

particolare anta profilo curvo
door with curved profile detail

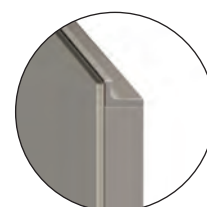

particolare anta profilo ad "ELLE"
door with "ELLE" shaped profile detail

Bridge



particolare maniglia
detail frame with handle

Vetro Lucido Verniciato Painted Glossy Glass

SP. 22 MM TH. 22 MM

anta vetro lucido
glossy glass doors

Neck cod. **N08**
Lux cod. **L08**
Bridge cod. **B08**



telaiο alluminio, vetro fumo
aluminum frame, smoke glass



particolare retro anta grigio cenere
detail of the back side of the door,
ash grey colour

COLORI FREDDI LUCIDO GLOSSY COLD COLOURS

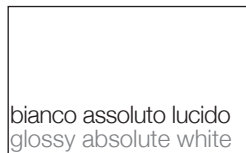

bianco assoluto lucido
glossy absolute white

Neck-Bridge (opz.V741)
Lux curvo (opz.C741)
Lux "ELLE" (opz.L741)

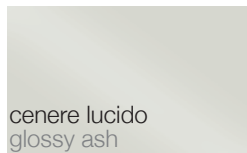

cenere lucido
glossy ash

Neck-Bridge (opz.V9548)
Lux curvo (opz.C9548)
Lux "ELLE" (opz.L9548)

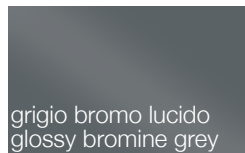

grigio bromo lucido
glossy bromine grey

Neck-Bridge (opz.V9534)
Lux curvo (opz.C9534)
Lux "ELLE" (opz.L9534)

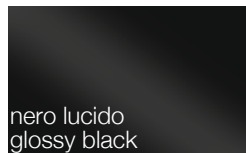

nero lucido
glossy black

Neck-Bridge (opz.V7893)
Lux curvo (opz.C7893)
Lux "ELLE" (opz.L7893)

COLORI CALDI LUCIDO GLOSSY WARM COLOURS

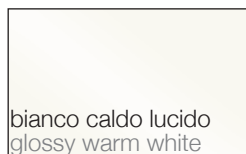

bianco caldo lucido
glossy warm white

Neck-Bridge (opz.V7402)
Lux curvo (opz.C7402)
Lux "ELLE" (opz.L7402)

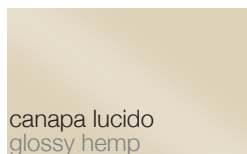

canapa lucido
glossy hemp

Neck-Bridge (opz.V8532)
Lux curvo (opz.C8532)
Lux "ELLE" (opz.L8532)

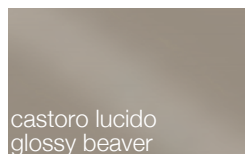

castoro lucido
glossy beaver

Neck-Bridge (opz.V8908)
Lux curvo (opz.C8908)
Lux "ELLE" (opz.L8908)

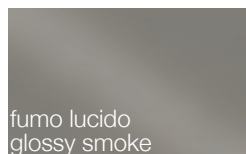

fumo lucido
glossy smoke

Neck-Bridge (opz.V9532)
Lux curvo (opz.C9532)
Lux "ELLE" (opz.L9532)

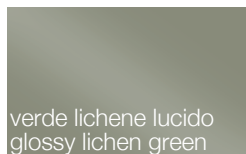

verde lichene lucido
glossy lichen green

Neck-Bridge (opz.V8464)
Lux curvo (opz.C8464)
Lux "ELLE" (opz.L8464)

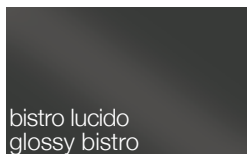

bistro lucido
glossy bistro

Neck-Bridge (opz.V9536)
Lux curvo (opz.C9536)
Lux "ELLE" (opz.L9536)



rosso toscano lucido
glossy tuscan red

Neck-Bridge (opz.V8158)
Lux curvo (opz.C8158)
Lux "ELLE" (opz.L8158)

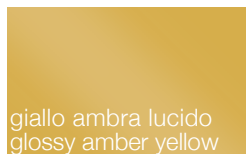

giallo ambra lucido
glossy amber yellow

Neck-Bridge (opz.V328)
Lux curvo (opz.C328)
Lux "ELLE" (opz.L328)

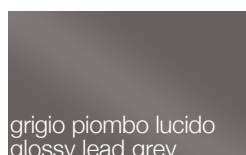

grigio piombo lucido
glossy lead grey

Neck-Bridge (opz.V9538)
Lux curvo (opz.C9538)
Lux "ELLE" (opz.L9538)

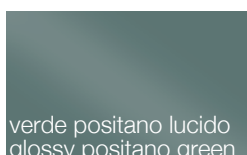

verde positano lucido
glossy positano green

Neck-Bridge (opz.V8472)
Lux curvo (opz.C8472)
Lux "ELLE" (opz.L8472)

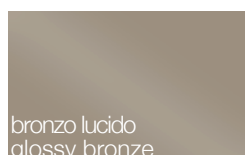

bronzo lucido
glossy bronze

Neck-Bridge (opz.V8904)
Lux curvo (opz.C8904)
Lux "ELLE" (opz.L8904)

Neck

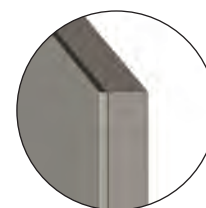

particolare anta squadrata
squared edge door detail

Lux

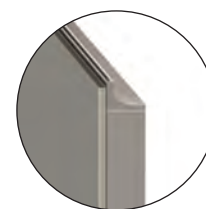

particolare anta profilo curvo
door with curved profile detail

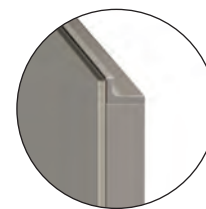

particolare anta profilo ad "ELLE"
door with "ELLE" shaped profile detail

Bridge



particolare maniglia
detail frame with handle

Telaio alluminio

Aluminium frame

[CLICCA QUI PER LA GAMMA DEI VETRI TELAIO ALLUMINIO](#)

[CLICK HERE FOR THE RANGE OF ALUMINIUM FRAMED GLASS](#)

Gres Mutina

Collezione Déchirer by Patricia Urquiola

SP. 22 MM TH. 22 MM

Neck cod. **N06**

Lux cod. **L06**

Bridge cod. **B06**

CARATTERISTICHE TECNICHE

N.B.: per le ante di finitura

Note: for finishing doors

ANTE E FRONTALI CASSETTI telaio alluminio verniciato a polvere finitura opaca tamburata nella parte posteriore con pannello HDF grigio cenere e frontale in gres mutina sp.3 mm nei colori: grafite (opz.G90B), avana (opz.G91B), gesso (opz.G92C)

GOLE vedi pag.36-37

MANIGLIE maniglia incorporata all'anta

STRUTTURE
ANTE MUTINA: grafite, avana
di serie : nobilitato lavagna (opz.9620) schiena e ripiano lavagna (opz.9620)
ANTA MUTINA: gesso
di serie : nobilitato conchiglia (opz.8910) schiena e ripiano conchiglia (opz.8910)

I PRODOTTI IN LEGNO SONO CONFORMI AL REGOLAMENTO (US EPA TSCA Title VI) RIGUARDO ALL'EMISSIONE DI FORMALDEIDE
WOODEN PRODUCTS ARE COMPLIANT WITH REGULATIONS (US EPA TSCA Title VI) GOVERNING FORMALDEHYDE EMISSIONS



MENSOLE vedi pag.56

ZOCCOLI vedi pag.57

TECHNICAL FEATURES

DOORS AND DRAWER FRONTS Aluminium frame dust painted matt finish, hollow-core back with a HDF panel ash grey colour and th.3 mm gres mutina front in the colours: graphite (opt.G90B), havana (opt.G91B), plaster (opt.G92C)

FINGER RAILS see page 36-37

HANDLES built-in door handle

STRUCTURES
MUTINA DOORS: graphite, havana
standard: melamine-coated slate grey (opt.9620), slate grey back panel and shelf (opt.9620)
MUTINA DOOR: plaster
standard: melamine-coated shell (opt.8910) back panel and shelf shell (opt.8910)

SHELVES see page 56

PLINTHS see page 57



Gres Mutina

Collezione Déchirer by Patricia Urquiola

SP. 22 MM TH. 22 MM

Neck cod. **N06**

Lux cod. **L06**

Bridge cod. **B06**

CARATTERISTICHE TECNICHE

N.B.: per le ante di finitura

Note: for finishing doors

GRES MUTINA

è un prodotto in gres porcellanato non smaltato ad impasto omogeneo ottenuto con tecnologia innovativa attraverso la compattazione del materiale e la successiva cottura in forno elettrico a temperature superiori a 1220°C circa, appositamente studiato per garantire l'uniformità del prodotto.

Le principali caratteristiche sono:

is a product not enamelled uniform mixture developed using innovative technology which compacts the material and increases precision. Natural materials such as quarried clay, granite rocks and ceramic pigments are wet worked and then hybrid-cooked in an electric oven at temperatures above 1220 °C to guarantee solidity.

The main features are:



RESISTENZA AGLI ATTACCHI CHIMICI

resiste ai solventi organici, inorganici, disinfettanti e detergenti. Si pulisce con estrema facilità mantenendo inalterate le caratteristiche della superficie; l'unico prodotto in grado di attaccare il prodotto è l'acido fluoridrico.

CHEMICAL RESISTANT

resists to organic and inorganic solvents, disinfectants and detergents. It can be easily cleaned without affecting its surface characteristics; the only product that can attack the slabs is hydrofluoric acid.



RESISTENZA ALL'USURA

resiste ai graffi e all'abrasione profonda. Le sue proprietà rimangono pertanto inalterate anche dopo un uso intensivo e una pulizia frequente.

WEAR RESISTANT

is highly scratchproof and resistant to deep abrasion. The properties of the slabs remain unchanged even after intensive use and frequent cleaning.



ELEVATA RESISTENZA ALLA FLESSIONE

presenta un elevato modulo di rottura.

HIGH FLEXURAL STRENGTH

has a high modulus of rupture.



REAZIONE AL FUOCO

non contiene materie organiche, pertanto, resiste al fuoco e alle alte temperature.

In caso d'incendio non sprigiona fumo e non emette sostanze tossiche.

FIRE RESISTANT

does not contain organic material therefore it is resistant to fire and high temperatures. In the event of fire it does not release smoke or toxic substances.



SUPERFICIE IGIENICA

è totalmente compatibile con le sostanze alimentari in quanto non rilascia elementi in soluzione.

Non consente l'insorgenza di muffe, batteri e funghi.

HYGIENIC SURFACE

is perfectly suitable for food substances since it does not release elements in solution. It does not allow the formation of mould, bacteria and fungi.



PROPRIETÀ CROMATICHE

Priva di pigmenti organici, resiste ai raggi UV. I colori non subiscono alcuna alterazione, anche

se sottoposti a variazioni delle condizioni climatiche.

CHROMATIC PROPERTIES

does not contain organic pigments and is resistant to UV rays. Even if subjected to severe climate changes, the colours remain stable.



ECO-COMPATIBILITÀ E RICICLABILITÀ

è un prodotto totalmente naturale. Non cede elementi all'ambiente e può essere facilmente

macinato e interamente riciclato in altri processi produttivi.

ECO-FRIENDLY AND RECYCLABLE

is a totally natural product. It does not release any elements into the environment and can be easily milled and recycled in other manufacturing processes.



ANTIGRAFFITI

è la prima superficie ceramica antigraffiti, si pulisce facilmente e non viene intaccato nemmeno

dalle vernici più tenaci.

GRAFFITI PROOF

is the first graffiti proof ceramic surface; it is easy to clean and even the strongest paints can be easily removed.

Gres Mutina

Collezione Déchirer by Patricia Urquiola

SP. 22 MM TH. 22 MM

Neck

cod. N06

Lux

cod. L06

Bridge

cod. B06

N.B.: per le ante di finitura

Note: for finishing doors

ante gres mutina
gres mutina doors



mutina grafite
telaio alluminio
laccato opaco bistro

graphite mutina,
bistro matt lacquered
aluminium frame

Neck - Bridge (opz.G90B)
Lux curvo (opz.CG90B)
Lux "ELLE" (opz.LG90B)

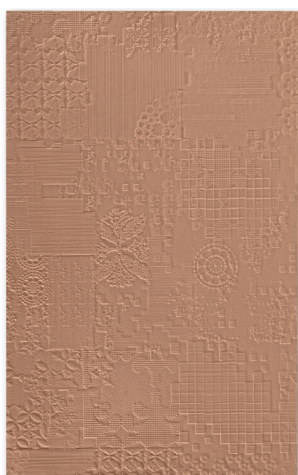

mutina avana
telaio alluminio
laccato opaco bistro

havana mutina,
bistro matt lacquered
aluminium frame

Neck - Bridge (opz.G91B)
Lux curvo (opz.CG91B)
Lux "ELLE" (opz.LG91B)

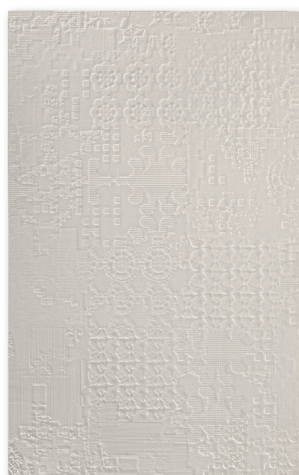

mutina gesso
telaio alluminio
laccato opaco conchiglia

plaster mutina,
coated shell matt lacquered
aluminium frame

Neck - Bridge (opz.G92C)
Lux curvo (opz.CG92C)
Lux "ELLE" (opz.LG92C)

Neck

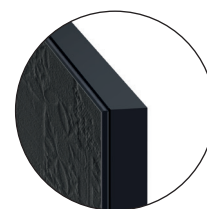

particolare anta squadrata
squared edge door detail

Lux

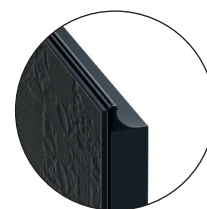

particolare anta profilo curvo
door with curved profile detail

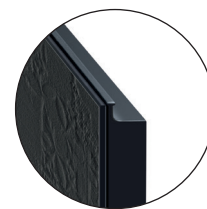

particolare anta profilo ad "ELLE"
door with "ELLE" shaped profile detail

Bridge



particolare maniglia
detail frame with handle



particolare retro anta grigio cenere
detail of the back side of the door,
ash grey colour



APERTURA CON GOLA OPENING BY FINGER RAIL

Neck

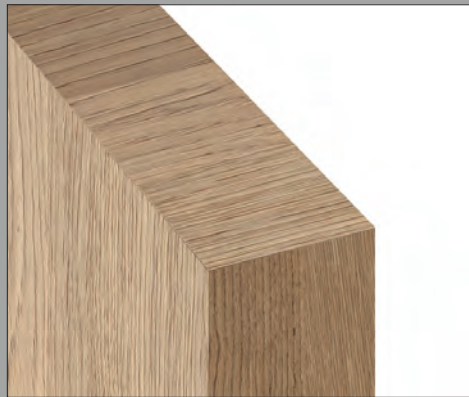

GOLA TIPO "ELLE"
"ELLE" TYPE FINGER RAIL

ANTA **NECK** PER GOLA TIPO "ELLE"

"NECK" DOOR FOR "ELLE" TYPE FINGER RAIL

LUX

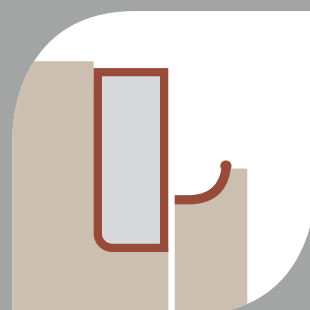
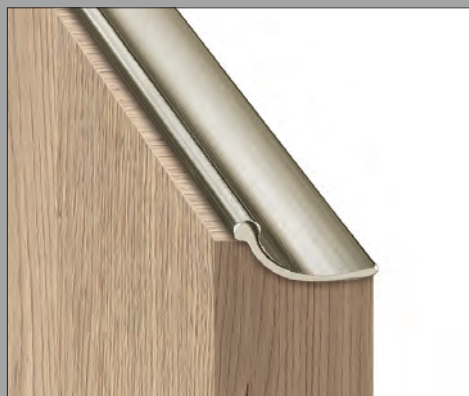

GOLA PIATTA
FLAT FINGER RAIL



GOLA TIPO "ELLE"
"ELLE" TYPE FINGER RAIL

ANTA CON PROFILO CURVO

(OPZ. P C + COD. COLORE)
DOOR WITH CURVED PROFILE

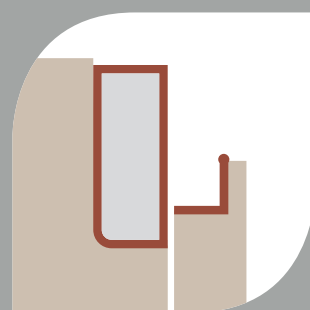
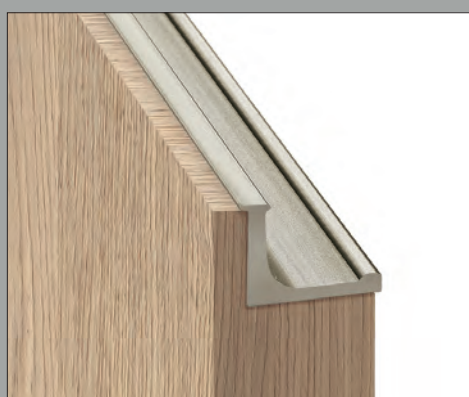

GOLA PIATTA
FLAT FINGER RAIL

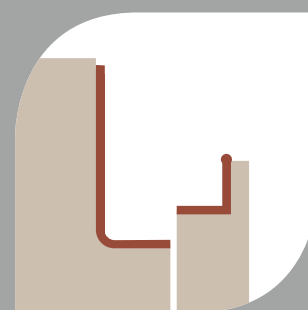

GOLA TIPO "ELLE"
"ELLE" TYPE FINGER RAIL

ANTA CON PROFILO AD "ELLE"

(OPZ. P L + COD. COLORE)
DOOR WITH "ELLE" SHAPED PROFILE



FINITURE GOLE E PROFILI SPAZZOLATI

FINGER RAILS AND PROFILES BRUSHED FINISHES



* opz. 412 brill non disponibile per profili

FINITURE GOLE E PROFILI VERNICIATI A POLVERE OPACHI

MATT FINGER RAILS AND PROFILES POWDER COATED FINISHES

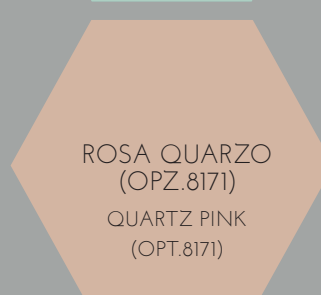
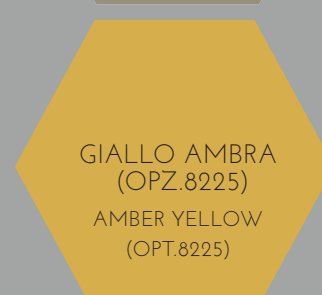
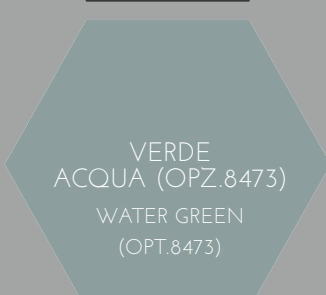
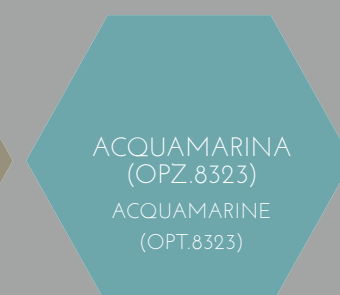
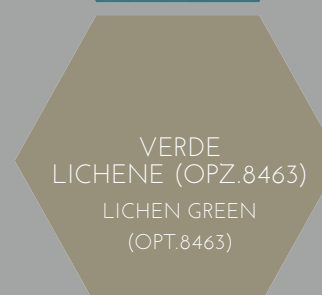
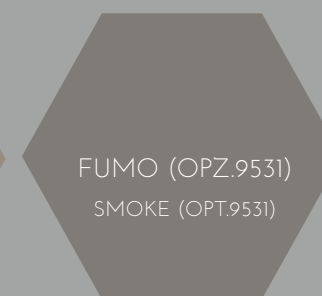

GOLE
PROFILI
FINGER RAILS
PROFILE

Neck

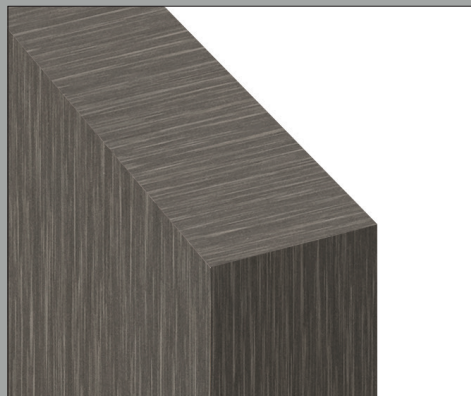

GOLA TIPO "ELLE"
"ELLE" TYPE FINGER RAIL

ANTA **NECK** PER GOLA TIPO "ELLE"

"NECK" DOOR FOR "ELLE" TYPE
FINGER RAIL

FINITURE GOLE SPAZZOLATE MATT FINGER RAILS BRUSHED FINISHES

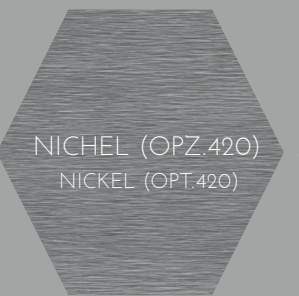

N.B.: ABBINAMENTO CONSIGLIATO
CON L'ANTA BRONZO BRUNITO
NOTE: BEST MATCHING WITH THE
BURNISHED BRONZE

FINITURE GOLE VERNICIATE A POLVERE OPACHE MATT FINGER RAILS POWDER COATED FINISHES

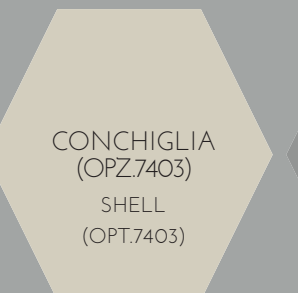

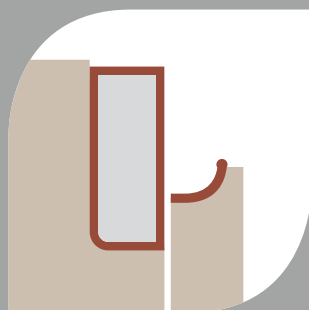

GOLA PIATTA
FLAT FINGER RAIL



GOLA TIPO "ELLE"
"ELLE" TYPE FINGER RAIL

ANTA CON
PROFILO CURVO
(OPZ.P.C + COD.COLORE)
DOOR WITH CURVED PROFILE

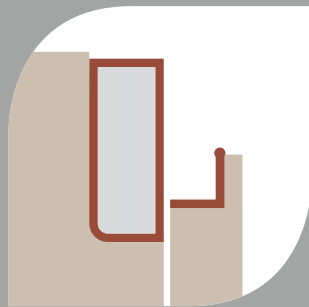
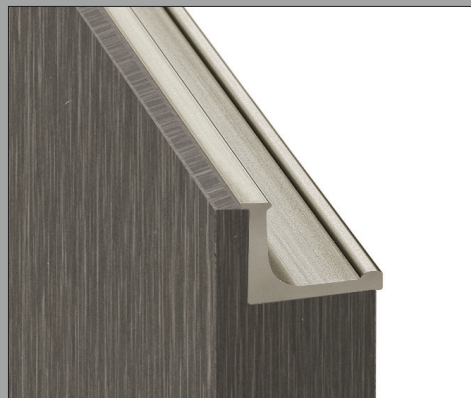

GOLA PIATTA
FLAT FINGER RAIL

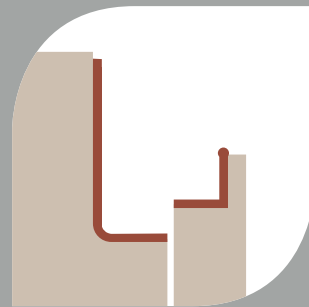

GOLA TIPO "ELLE"
"ELLE" TYPE FINGER RAIL

ANTA CON
PROFILO AD "ELLE"
(OPZ.P.L + COD.COLORE)
DOOR WITH "ELLE" SHAPED PROFILE

FINITURE GOLE E PROFILO SPAZZOLATO

MATT FINGER RAILS AND PROFILE BRUSHED FINISHES



N.B.: ABBINAMENTO CONSIGLIATO
CON L'ANTA BRONZO BRUNITO
NOTE: BEST MATCHING WITH THE
BURNISHED BRONZE





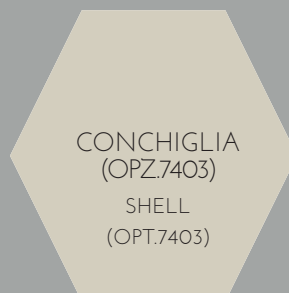

FINITURE GOLE E PROFILO VERNICIATI A POLVERE OPACHI

MATT FINGER RAILS AND PROFILE POWDER COATED FINISHES



GOLA "ELLE" ORIZZONTALE SOTTOTOP

UNDERMOUNT HORIZONTAL "ELLE" FINGER RAIL





	COD.			COD.	
<p>Gola sottotop tipo "A" Type "A" undermount finger rail</p> 				<p>Angolo interno a 90° per gola tipo "A" 90° interior corner for "A" type finger rail</p> 	
	al ml per lm	G950010		cadauno each	G950050
<p>Terminale aperto dx o sx per gola tipo "A" da utilizzare a fine composizione RH or LH open end for type "A" finger rail to be placed at the end of the composition</p> 				<p>Angolare con snodo per unione fuori squadra per gola tipo "A" Corner piece with joint for out-of-plumb joining for type "A" finger rail</p> 	
	terminale DX RH end	G950021			
	terminale SX LH end	G950022			
<p>Terminale chiuso dx o sx per gola tipo "A" da utilizzare solo tra basi e colonne RH or LH closure for type "A" finger rail to be placed only between base units and column</p> 					
	terminale DX RH end	G950031			
	terminale SX LH end	G950032			
					G950060
<p>Angolo esterno a 90° per gola tipo "A" 90° external corner for "A" type finger rail</p> 					
	cadauno each	G950055			





GOLA "ELLE" ORIZZONTALE INTERMEDIA

INTERMEDIATE HORIZONTAL "ELLE" FINGER RAIL

GOLE "ELLE" VERTICALI PER COLONNE

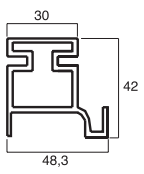
VERTICAL "ELLE" FINGER RAILS FOR COLUMNS

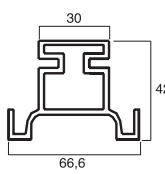
	COD.	
<p>Gola intermedia tipo "B"</p> <p>Type "B" intermediate finger rail</p>  <p style="text-align: right;">al ml per lm</p>	G950110	
<p>Terminale aperto dx o sx per gola tipo "B" da utilizzare a fine composizione</p> <p>RH or LH open end for type "B" finger rail to be placed at the end of the composition</p>  <p style="text-align: right;">terminale DX RH end terminale SX LH end</p>	G950121 G950122	
<p>Terminale chiuso dx o sx per gola tipo "B" da utilizzare solo tra cassettiere e lavastoviglie/colonne</p> <p>RH or LH closure for type "B" finger rail to be placed only between drawer units and dishwasher/columns</p>  <p style="text-align: right;">terminale DX RH end terminale SX LH end</p>	G950131 G950132	
<p>Angolo esterno a 90° per gola tipo "B"</p> <p>90° external corner for "B" type finger rail</p>  <p style="text-align: right;">cadauno each</p>	G950155	

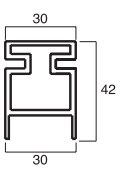
	COD.	
<p>Mezza gola verticale tipo "C" (completa di distanziale)</p> <p>Type "C" half vertical finger rail (complete with spacer)</p>   <p style="text-align: center;">sezione mezza gola tipo "C" cross section of type "C" finger rail</p> <p style="text-align: right;">al ml per lm</p>	G950310 G950330 G950350 G950390 G950390	H 96 H 132 H 204 H 240 H 252
<p>Gola verticale intermedia tipo "D" (completa di distanziale)</p> <p>Type "D" intermediate vertical finger rail (complete with spacer)</p>   <p style="text-align: center;">sezione gola tipo "D" cross section of type "D" finger rail</p> <p style="text-align: right;">al ml per lm</p>	G950410 G950430 G950450 G950490 G950490	H 96 H 132 H 204 H 240 H 252
<p>Gola verticale laterale tipo "E" (completa di distanziale)</p> <p>Type "E" lateral vertical finger rail (complete with spacer)</p>   <p style="text-align: center;">sezione gola tipo "E" cross section of type "E" finger rail</p> <p style="text-align: right;">al ml per lm</p>	G950510 G950530 G950550 G950590 G950590	H 96 H 132 H 204 H 240 H 252

NOZIONI UTILI - gole "elle" orizzontali per basi

USEFUL INFORMATION - HORIZONTAL "ELLE" FINGER RAILS FOR BASE UNITS

VISTA FRONTALE ZOCCOLO H 13 PER BASI H 88

FRONT VIEW PLINTH H 13 FOR BASE UNITS H 88

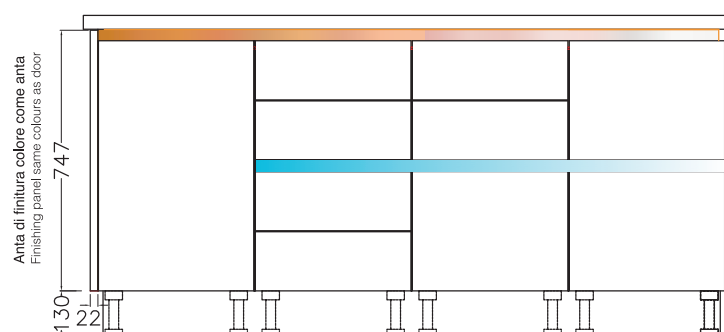
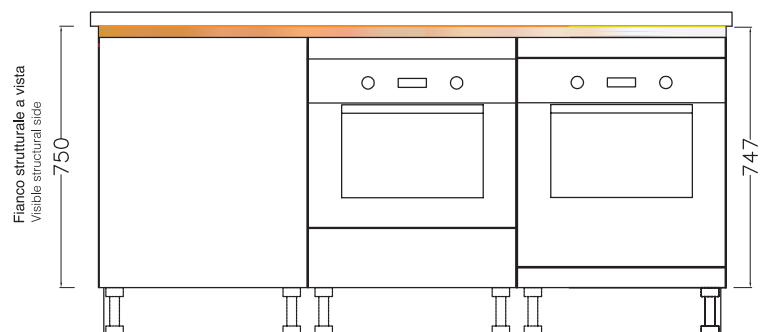

VISTA LATERALE (sezione) ZOCCOLO H 13 PER BASI H 88

SIDE VIEW (CROSS SECTION) PLINTH H 13 FOR BASE UNITS H 88

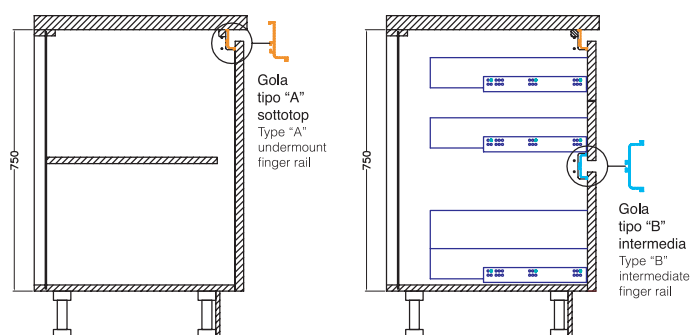

VISTA DALL'ALTO

TOP VIEW

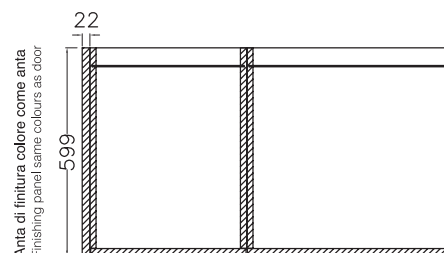
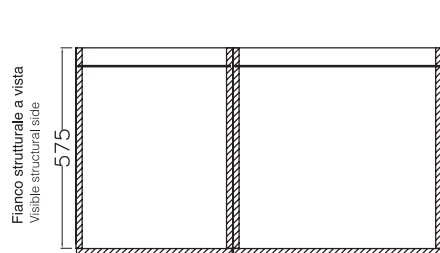

Composizione con ante di finitura laterali: alla dimensione finale della cucina, sommare sempre lo spessore delle ante di finitura (ogni anta 2,2 cm)

Composition with side finishing panels: to the final size of the kitchen, always add the thickness of the finishing panels (each panel 2,2 cm)

NOZIONI UTILI - gole "elle" verticali per colonne

USEFUL INFORMATION - VERTICAL "ELLE" FINGER RAILS FOR COLUMNS

VISTA FRONTALE ZOCCOLO H 13

FRONT VIEW PLINTH H 13

N.B.: per la versione Lux sulle colonne il profilo anta è sempre verticale
 Note: door profile on the columns for Lux version is always vertical

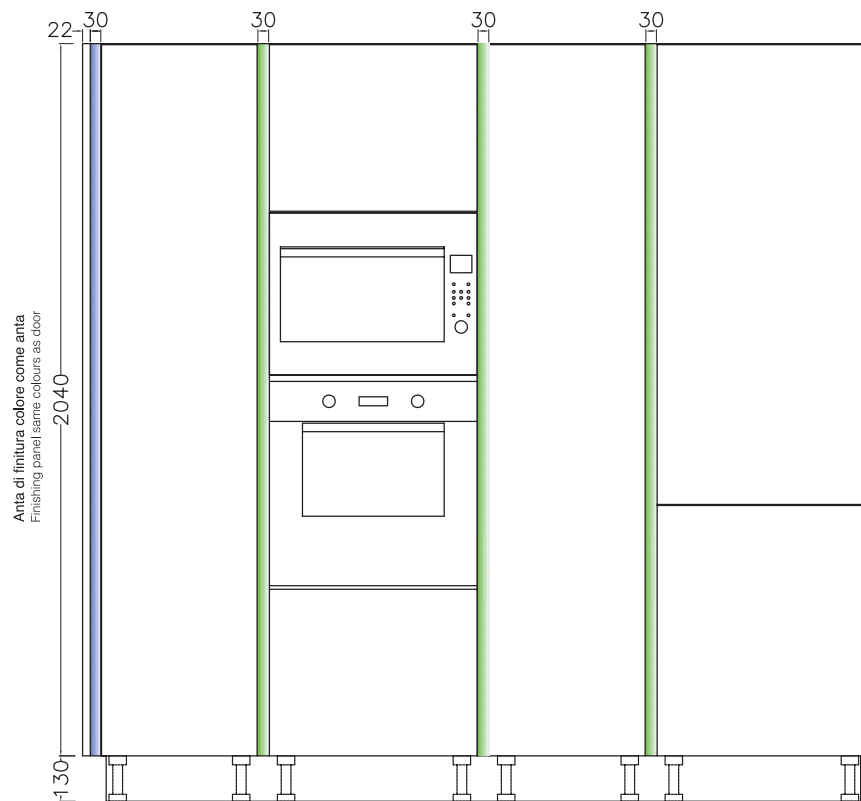

VISTA DALL'ALTO

TOP VIEW

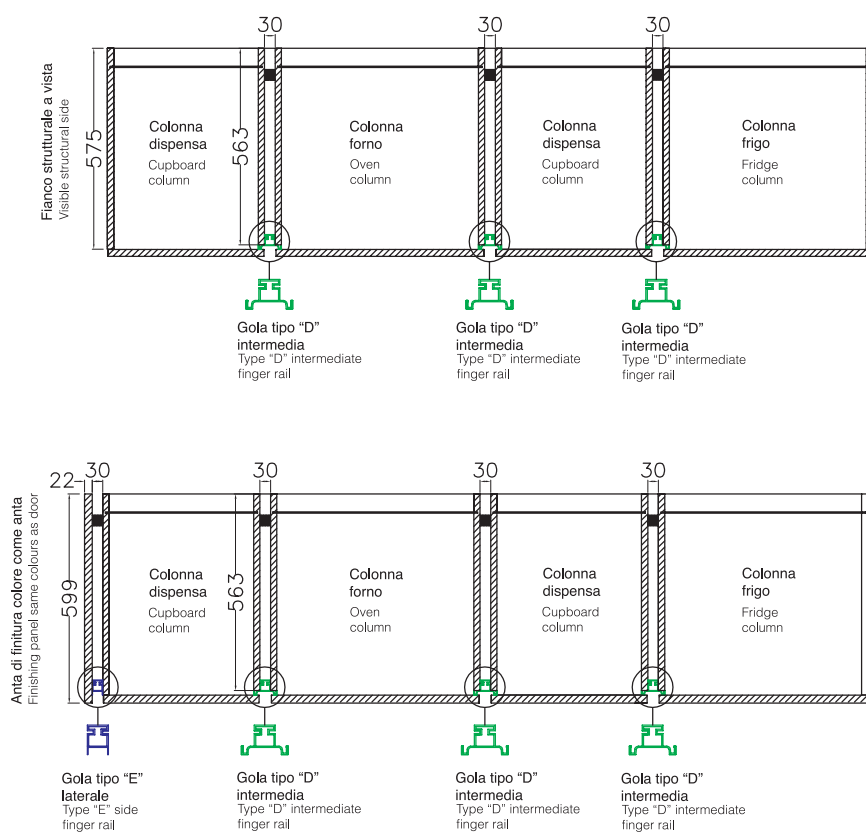

Composizione fianco strutturale a vista come anta:
 alla dimensione finale della cucina, sommare sempre lo spessore dei distanziali tra le colonne (ogni distanziale 3 cm)

Composition with visible side panel to match door:
 to the final size of the kitchen, always add the thickness of the spacers between the two columns (each spacer 3 cm)

Composizione con ante di finitura laterali, alla dimensione finale della cucina, sommare sempre lo spessore dei distanziali tra le colonne (ogni distanziale 3 cm) e lo spessore delle ante di finitura (ogni anta 2,2 cm)







Composition with side finishing panels to the final size of the kitchen, always add the thickness of the spacer between the two columns (each spacer 3 cm) and the thickness of the finishing panels (each panel 22 mm)

GOLA PIATTA ORIZZONTALE INTERMEDIA

INTERMEDIATE HORIZONTAL **FLAT** FINGER RAIL

GOLE VERTICALI PIATTE PER COLONNE

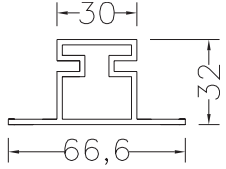
VERTICAL **FLAT** FINGER RAILS FOR COLUMNS

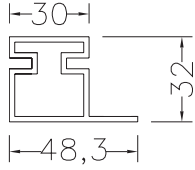
	COD.			
<p>Gola piatta intermedia tipo "BP" Type "BP" intermediate flat finger rail</p> 				
	<p>al ml per lm</p> <p>G960110</p>			
<p>Terminale chiuso "T3" dx o sx per gola tipo "BP" da utilizzare a fine composizione "T3" RH or LH closure for type "BP" finger rail to be placed at the end of the composition</p> 				
	<p>terminale DX RH end</p> <p>G960121</p> <p>terminale SX LH end</p> <p>G960122</p>			
<p>Terminale chiuso "T4" dx o sx per gola tipo "BP" da utilizzare solo tra cassettiere e lavastoviglie/colonne "T4" RH or LH closure for type "BP" finger rail To be placed only between drawer units and dishwasher/columns</p> 				
	<p>terminale DX RH end</p> <p>G960131</p> <p>terminale SX LH end</p> <p>G960132</p>			
<p>Angolo esterno a 90° per gola tipo "BP" 90° external corner for "BP" type finger rail</p> 				
	<p>cadauno each</p> <p>G960155</p>			
<p>Gola verticale piatta intermedia tipo "DP" (completa di distanziale) Type "DP" intermediate vertical flat finger rail (complete with spacer)</p> 				
	<p>Sezione gola tipo "DP" Cross section of type "DP" finger rail</p>  <p>H 96</p> <p>H 132</p> <p>H 204</p> <p>al ml per lm</p> <p>H 240</p> <p>H 252</p>			
<p>Gola verticale piatta laterale tipo "CP" (completa di distanziale) Type "CP" vertical side flat finger rail (complete with spacer)</p> 				
	<p>Sezione gola tipo "CP" Cross section of type "CP" finger rail</p>  <p>H 96</p> <p>H 132</p> <p>H 204</p> <p>al ml per lm</p> <p>H 240</p> <p>H 252</p>			

NOZIONI UTILI - gole orizzontali **piatte** per basi

USEFUL INFORMATION - HORIZONTAL **FLAT** FINGER RAILS FOR BASE UNITS

VISTA FRONTALE ZOCCOLO H 13 PER BASI H 88

FRONT VIEW PLINTH H 13 FOR BASE UNITS H 88

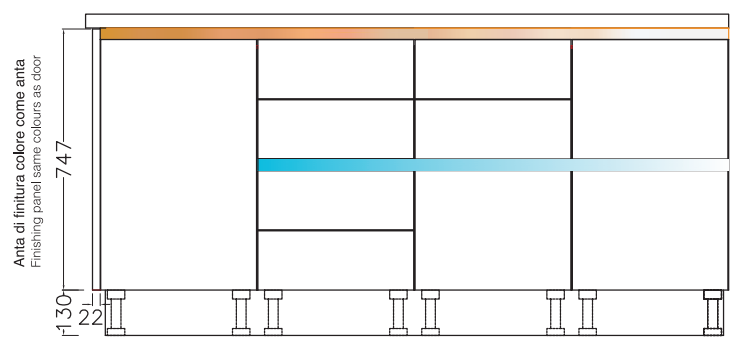
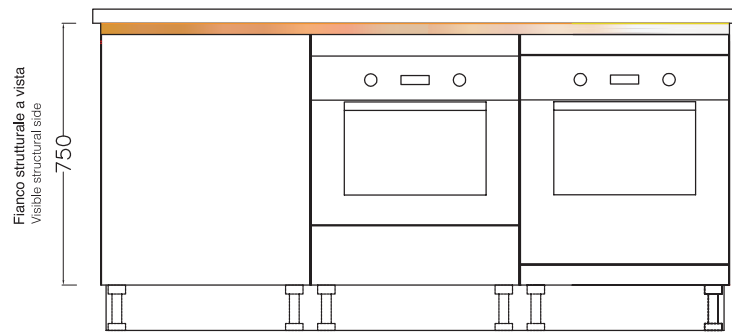

VISTA LATERALE (sezione) ZOCCOLO H 13 PER BASI H 88

SIDE VIEW (CROSS SECTION) PLINTH H 13 FOR BASE UNITS H 88

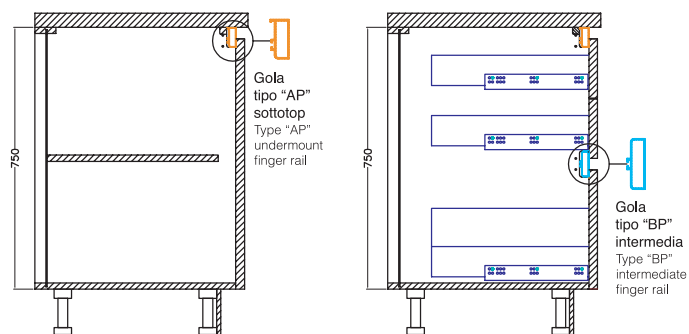

VISTA DALL'ALTO

TOP VIEW

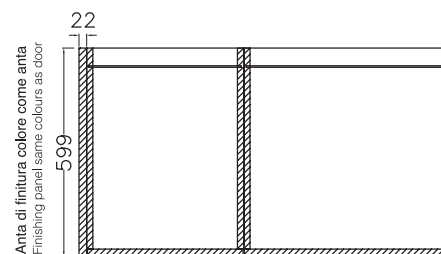
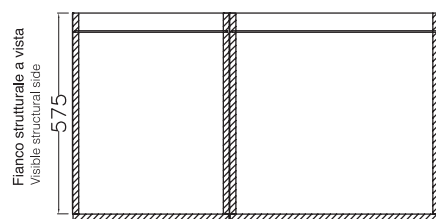

Composizione con ante di finitura laterali: alla dimensione finale della cucina, sommare sempre lo spessore delle ante di finitura (ogni anta 2,2 cm)

Composition with side finishing panels: to the final size of the kitchen, always add the thickness of the finishing panels (each panel 22 mm)

NOZIONI UTILI - gole verticali **piatte** per colonne

USEFUL INFORMATION - VERTICAL **FLAT** FINGER RAILS FOR COLUMNS

VISTA FRONTALE ZOCCOLO H 13

FRONT VIEW PLINTH H 13

N.B.: per la versione Lux sulle colonne il profilo anta è sempre verticale

Note: door profile on the columns for Lux version is always vertical

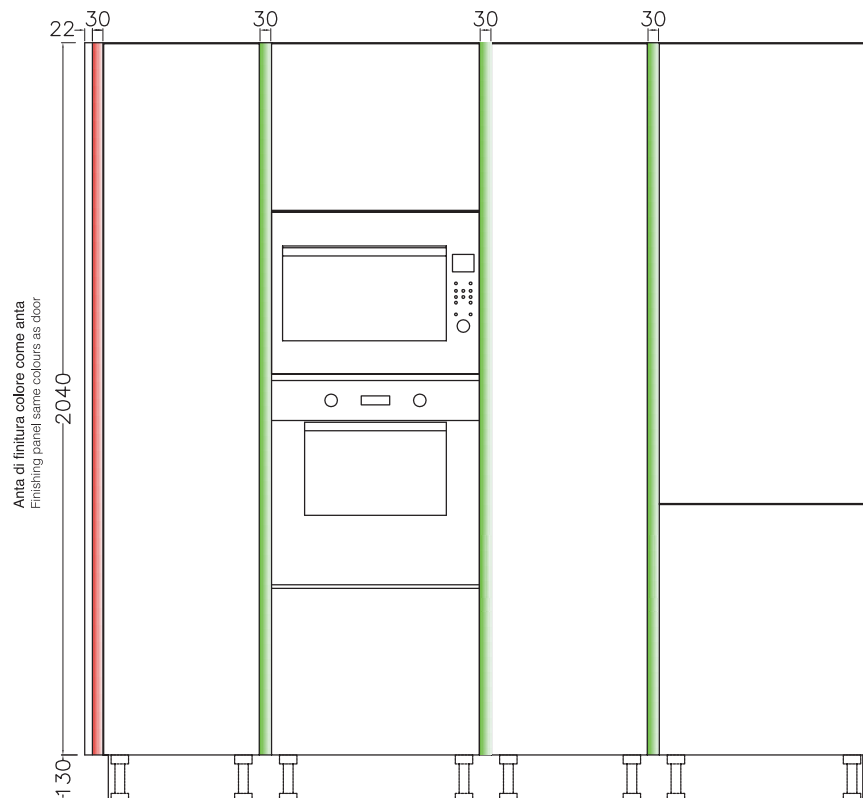

VISTA DALL'ALTO

TOP VIEW

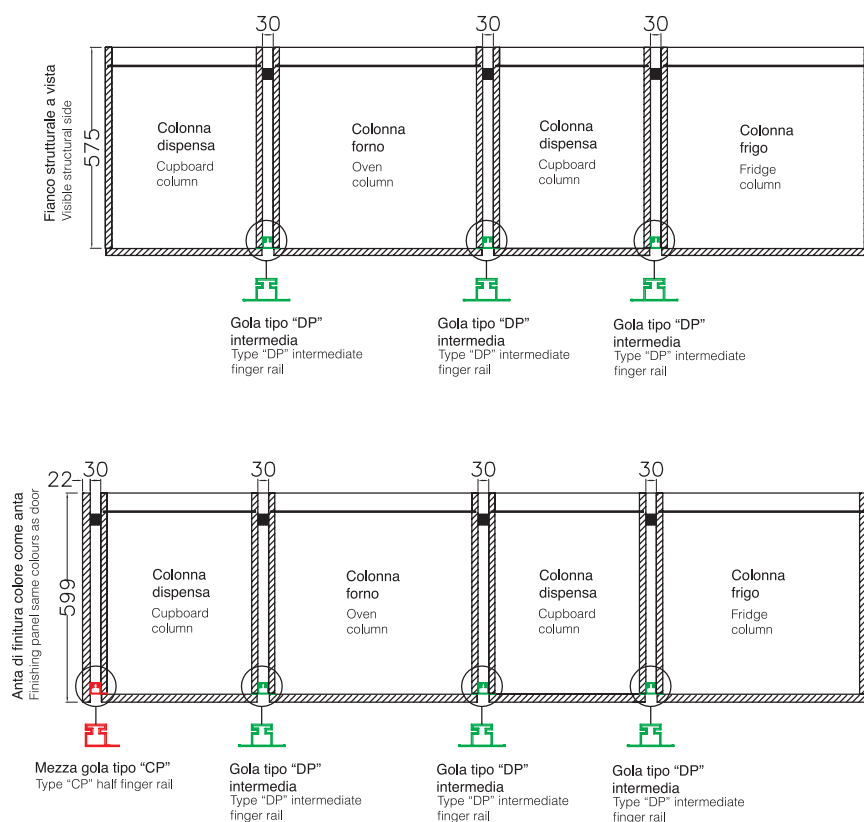

Composizione fianco strutturale a vista come anta:
alla dimensione finale della cucina, sommare sempre lo spessore dei distanziali tra le colonne (ogni distanziale 3 cm)

Composition with visible side panel to match door:
to the final size of the kitchen, always add the thickness of the spacers between the two columns (each spacer 3 cm)

Composizione con ante di finitura laterali, alla dimensione finale della cucina, sommare sempre lo spessore dei distanziali tra le colonne (ogni distanziale 3 cm) e lo spessore delle ante di finitura (ogni anta 2,2 cm)

Composition with side finishing panels to the final size of the kitchen, always add the thickness of the spacer between the two columns (each spacer 3 cm) and the thickness of the finishing panels (each panel 22 mm)

MANIGLIE HANDLES

Bridge

DI SERIE STANDARD **NEW**



Maniglia 572 finitura nichel perla satinato
 anta L 15 → passo 64 mm
 anta da L 30 a L 45 → passo 160 mm
 anta da L 60 a L 120 → passo 320 mm

Handle 572 pearl satin nickel finish
 door W 15 → centre-to-centre distance 64 mm
 door from W 30 to W 45 → centre-to-centre distance 160 mm
 door from W 60 to W 120 → centre-to-centre distance 320 mm

A RICHIESTA ON REQUEST **NEW**



Maniglia 579N finitura nichel satinato
 anta L 15 → passo 64 mm
 anta da L 30 a L 60 → passo 160 mm
 anta da L 90 a L 120 → passo 320 mm

Handle 579N satin nickel finish
 door W 15 → centre-to-centre distance 64 mm
 door from W 30 to W 60 → centre-to-centre distance 160 mm
 door from W 90 to W 120 → centre-to-centre distance 320 mm

NEW



Maniglia 579A finitura verniciata antracite
 anta L 15 → passo 64 mm
 anta da L 30 a L 60 → passo 160 mm
 anta da L 90 a L 120 → passo 320 mm

Handle 579A coated anthracite finish
 door W 15 → centre-to-centre distance 64 mm
 door from W 30 to W 60 → centre-to-centre distance 160 mm
 door from W 90 to W 120 → centre-to-centre distance 320 mm



Maniglia 568 finitura nichel satinato
 anta L 15 → passo 64 mm
 anta da L 30 a L 45 → passo 160 mm
 anta da L 60 a L 120 → passo 320 mm

Handle 568 satin nickel finish
 door W 15 → centre-to-centre distance 64 mm
 door from W 30 to W 45 → centre-to-centre distance 160 mm
 door from W 60 to W 120 → centre-to-centre distance 320 mm

NEW



Maniglia 568A finitura verniciata antracite
 anta L 15 → passo 64 mm
 anta da L 30 a L 45 → passo 160 mm
 anta da L 60 a L 120 → passo 320 mm

Handle 568A coated anthracite finish
 door W 15 → centre-to-centre distance 64 mm
 door from W 30 to W 45 → centre-to-centre distance 160 mm
 door from W 60 to W 120 → centre-to-centre distance 320 mm

NEW



Maniglia 568G finitura verniciata grigio chiaro
 anta L 15 → passo 64 mm
 anta da L 30 a L 45 → passo 160 mm
 anta da L 60 a L 120 → passo 320 mm

Handle 568G coated light grey finish
 door W 15 → centre-to-centre distance 64 mm
 door from W 30 to W 45 → centre-to-centre distance 160 mm
 door from W 60 to W 120 → centre-to-centre distance 320 mm



Maniglia 567 finitura nichel satinato
 anta L 15 → passo 64 mm
 anta da L 30 a L 45 → passo 160 mm
 anta da L 60 a L 120 → passo 320 mm

Handle 567 satin nickel finish
 door W 15 → centre-to-centre distance 64 mm
 door from W 30 to W 45 → centre-to-centre distance 160 mm
 door from W 60 to W 120 → centre-to-centre distance 320 mm

NEW



Maniglia 567A finitura soft verniciata antracite
 anta L 15 → passo 64 mm
 anta da L 30 a L 45 → passo 160 mm
 anta da L 60 a L 120 → passo 320 mm

Handle 567A coated soft anthracite finish
 door W 15 → centre-to-centre distance 64 mm
 door from W 30 to W 45 → centre-to-centre distance 160 mm
 door from W 60 to W 120 → centre-to-centre distance 320 mm

NEW



Maniglia 567R finitura soft verniciata rame antico
 anta L 15 → passo 64 mm
 anta da L 30 a L 45 → passo 160 mm
 anta da L 60 a L 120 → passo 320 mm

Handle 567R soft finish painted antique copper
 door W 15 → centre-to-centre distance 64 mm
 door from W 30 to W 45 → centre-to-centre distance 160 mm
 door from W 60 to W 120 → centre-to-centre distance 320 mm

NEW



Maniglia 584 finitura antracite
 anta L 15 → passo 64 mm
 anta da L 30 a L 45 → passo 160 mm
 anta da L 60 a L 120 → passo 320 mm

Handle 584 anthracite finish
 door W 15 → centre-to-centre distance 64 mm
 door from W 30 to W 45 → centre-to-centre distance 160 mm
 door from W 60 to W 120 → centre-to-centre distance 320 mm



Maniglia 491 finitura inox satinato
 anta L 15 → passo 96 mm
 anta da L 30 a L 45 → passo 160 mm
 anta da L 60 a L 120 → passo 320 mm

Handle 491 stainless steel satin finish
 door W 15 → centre-to-centre distance 96 mm
 door from W 30 to W 45 → centre-to-centre distance 160 mm
 door from W 60 to W 120 → centre-to-centre distance 320 mm

MANIGLIE HANDLES

Bridge

NEW



Maniglia 586 finitura bronzo
anta L 15 → passo 160 mm in verticale
anta da L 30 a L 45 → passo 160 mm
anta da L 60 a L 120 → passo 320 mm

Handle 586 bronze finish
door W 15 → centre-to-centre distance 160 mm vertical
door from W 30 to W 45 → centre-to-centre distance 160 mm
door from W 60 to W 120 → centre-to-centre distance 320 mm

NEW



Maniglia 583 finitura nichel satinato
anta L 15 → passo 160 mm in verticale
anta da L 30 a L 45 → passo 160 mm
anta da L 60 a L 120 → passo 320 mm

Handle 583 satin nickel finish
door W 15 → centre-to-centre distance 160 mm vertical
door from W 30 to W 45 → centre-to-centre distance 160 mm
door from W 60 to W 120 → centre-to-centre distance 320 mm

NEW



Maniglia 582 finitura nichel satinato
anta L 15 → passo 160 mm in verticale
anta da L 30 a L 45 → passo 160 mm
anta da L 60 a L 120 → passo 320 mm

Handle 582 satin nickel finish
door W 15 → centre-to-centre distance 160 mm vertical
door from W 30 to W 45 → centre-to-centre distance 160 mm
door from W 60 to W 120 → centre-to-centre distance 320 mm

MANIGLIA AD INCASSO BUILT-IN HANDLE NEW



Maniglia 952 finitura antracite
anta L 15 → lunghezza 100 mm
anta da L 30 a L 45 → lunghezza 165 mm
anta da L 60 a L 120 → lunghezza 292 mm

Handle 952 anthracite finish
door W 15 → length 100 mm
door from W 30 to W 45 → length 165 mm
door from W 60 to W 120 → length 292 mm



Maniglia 945T finitura titanio
anta L 15 → passo 180 mm in verticale
anta da L 30 a L 120 → passo 180 mm

Handle 945T titanium finish
door W 15 → centre-to-centre distance 180 mm vertical
door from W 30 to W 120 → centre-to-centre distance 180 mm



Maniglia 945L finitura lavagna
anta L 15 → passo 180 mm in verticale
anta da L 30 a L 120 → passo 180 mm

Handle 945L slate grey finish
door W 15 → centre-to-centre distance 180 mm vertical
door from W 30 to W 120 → centre-to-centre distance 180 mm

MANIGLIE

HANDLES

Bridge

A RICHIESTA ON REQUEST

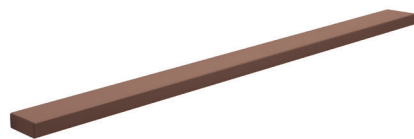

Maniglia 59RA finitura anodizzato rame anticato
anta L 15 → passo 32 mm
anta L 30 a L 45 → passo 160 mm
anta da L 60 a L 120 → passo 448 mm

Handle 59RA oxidized antique copper finish
door W 15 → centre-to-centre distance 32 mm
door W 30 to W 45 → centre-to-centre distance 160 mm
door from W 60 to W 120 → centre-to-centre distance 448 mm

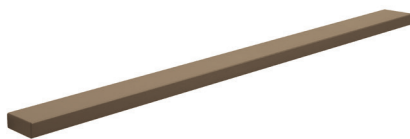

Maniglia 59BA finitura anodizzato bronzo anticato
anta L 15 → passo 32 mm
anta L 30 a L 45 → passo 160 mm
anta da L 60 a L 120 → passo 448 mm

Handle 59BA oxidized antique bronze finish
door W 15 → centre-to-centre distance 32 mm
door W 30 to W 45 → centre-to-centre distance 160 mm
door from W 60 to W 120 → centre-to-centre distance 448 mm

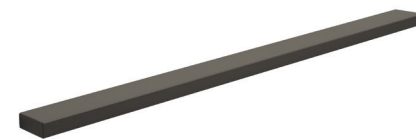

Maniglia 59BB finitura anodizzato titanio
anta L 15 → passo 32 mm
anta L 30 a L 45 → passo 160 mm
anta da L 60 a L 120 → passo 448 mm

Handle 59BB oxidized titanium finish
door W 15 → centre-to-centre distance 32 mm
door W 30 to W 45 → centre-to-centre distance 160 mm
door from W 60 to W 120 → centre-to-centre distance 448 mm

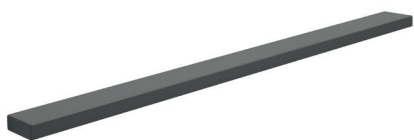

Maniglia 59F finitura anodizzato grafite
anta L 15 → passo 32 mm
anta L 30 a L 45 → passo 160 mm
anta da L 60 a L 120 → passo 448 mm

Handle 59F oxidized graphite finish
door W 15 → centre-to-centre distance 32 mm
door W 30 to W 45 → centre-to-centre distance 160 mm
door from W 60 to W 120 → centre-to-centre distance 448 mm

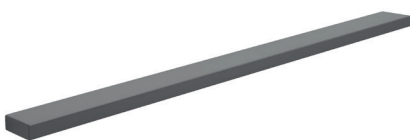

Maniglia 59K finitura anodizzato acciaio
anta L 15 → passo 32 mm
anta L 30 a L 45 → passo 160 mm
anta da L 60 a L 120 → passo 448 mm

Handle 59K oxidized stainless steel finish
door W 15 → centre-to-centre distance 32 mm
door W 30 to W 45 → centre-to-centre distance 160 mm
door from W 60 to W 120 → centre-to-centre distance 448 mm



Maniglia 59N finitura anodizzato nero
anta L 15 → passo 32 mm
anta L 30 a L 45 → passo 160 mm
anta da L 60 a L 120 → passo 448 mm

Handle 59N oxidized black finish
door W 15 → centre-to-centre distance 32 mm
door W 30 to W 45 → centre-to-centre distance 160 mm
door from W 60 to W 120 → centre-to-centre distance 448 mm



Maniglia 57RA finitura rame anticato
anta L 15 → passo 12 mm
anta L 30 a L 45 → passo 160 mm
anta da L 60 a L 120 → passo 320 mm

Handle 57RA antique copper finish
door W 15 → centre-to-centre distance 12 mm
door W 30 to W 45 → centre-to-centre distance 160 mm
door from W 60 to W 120 → centre-to-centre distance 320 mm



Maniglia 57BA finitura bronzo anticato
anta L 15 → passo 12 mm
anta L 30 a L 45 → passo 160 mm
anta da L 60 a L 120 → passo 320 mm

Handle 57BA antique bronze finish
door W 15 → centre-to-centre distance 12 mm
door W 30 to W 45 → centre-to-centre distance 160 mm
door from W 60 to W 120 → centre-to-centre distance 320 mm



Maniglia 57BB finitura bronzo brunito
anta L 15 → passo 12 mm
anta L 30 a L 45 → passo 160 mm
anta da L 60 a L 120 → passo 320 mm

Handle 57BB burnished bronze finish
door W 15 → centre-to-centre distance 12 mm
door W 30 to W 45 → centre-to-centre distance 160 mm
door from W 60 to W 120 → centre-to-centre distance 320 mm



Maniglia 57F finitura grafite
anta L 15 → passo 12 mm
anta L 30 a L 45 → passo 160 mm
anta da L 60 a L 120 → passo 320 mm

Handle 57F graphite finish
door W 15 → centre-to-centre distance 12 mm
door W 30 to W 45 → centre-to-centre distance 160 mm
door from W 60 to W 120 → centre-to-centre distance 320 mm



Maniglia 57K finitura nichel
anta L 15 → passo 12 mm
anta L 30 a L 45 → passo 160 mm
anta da L 60 a L 120 → passo 320 mm

Handle 57K nickel finish
door W 15 → centre-to-centre distance 12 mm
door W 30 to W 45 → centre-to-centre distance 160 mm
door from W 60 to W 120 → centre-to-centre distance 320 mm

MANIGLIA ORIZZONTALE M50 **NEW**

M50 HANDLE HORIZONTAL

Bridge



Maniglia M50 finitura titanio
 passo in funzione dell'anta
 Handle M50 titanium finish
 centre-to-centre distance varies according to the door

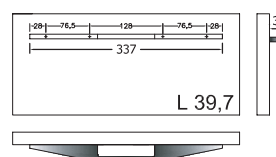
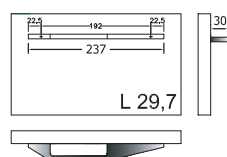
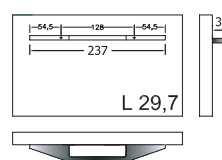
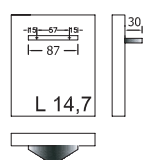

ANGOLO PENSILE A LIBRO
 corner wall unit folding

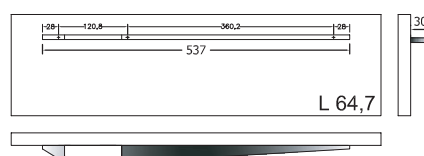
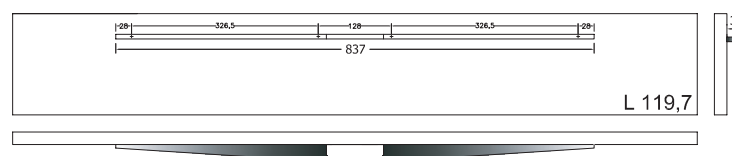
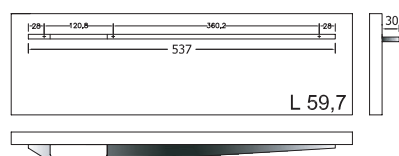
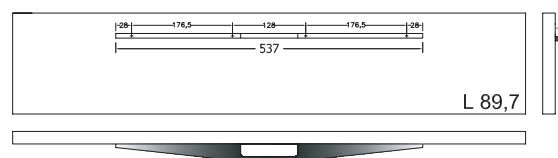
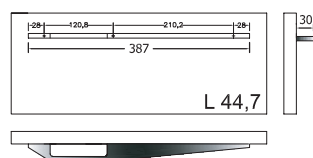
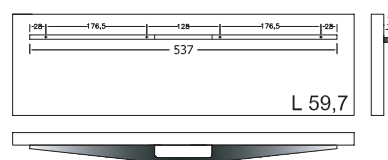
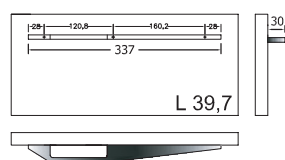
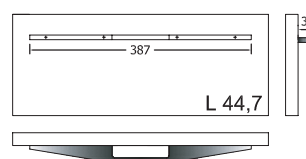
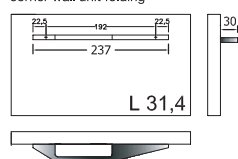

MANIGLIA VERTICALE M50V **NEW**

M50V HANDLE VERTICAL

Bridge



Maniglia M50V finitura titanio
 passo in funzione dell'anta
 Handle M50V titanium finish
 centre-to-centre distance varies according to the door

CASSETTI E CESTONE
 DRAWERS AND DEEP DRAWER

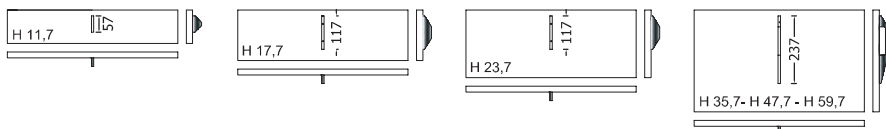

BASE
 BASE UNIT

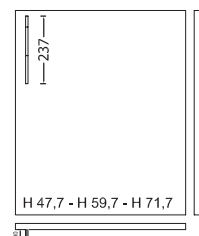

ANTA LAVASTOVIGLIE
ANTA CESTELLO ESTRAIBILE
 DISHWASHER DOOR
 PULL-OUT BASKET DRAWER DOOR

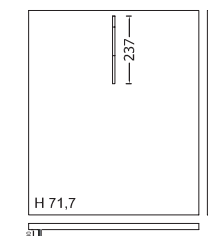

PENSILE
 WALL UNIT

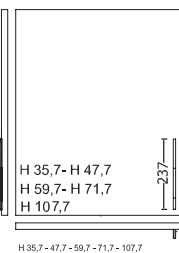

RIBALTA
 FLAP DOOR

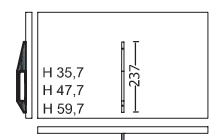

COLONNA 1 ANTA
 COLUMN DOOR

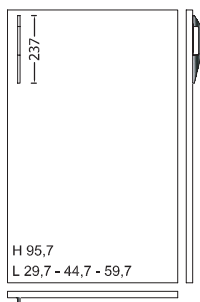

COLONNA ANTA CESTELLO ESTRAIBILE
 COLUMN PULL-OUT BASKET DRAWER DOOR

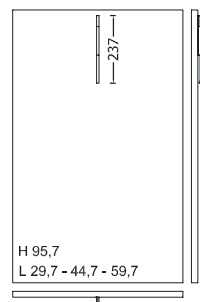

COLONNA 1 ANTA
 COLUMN DOOR

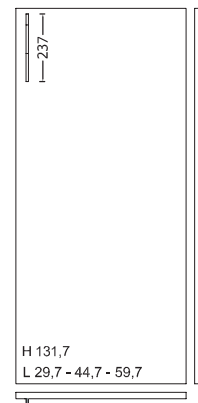

COLONNA ANTA CESTELLO ESTRAIBILE
 COLUMN PULL-OUT BASKET DRAWER DOOR

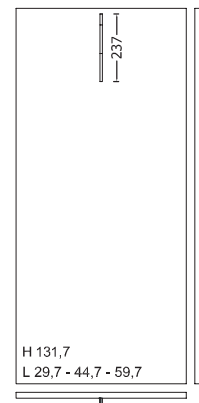

COLONNA FRIGO - DISPENSA 1 ANTA
 COLUMN FRIDGE - CABINET DOOR

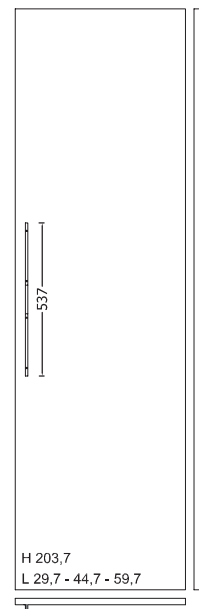

COLONNA ANTA CESTELLO ESTRAIBILE
 COLUMN PULL-OUT BASKET DRAWER DOOR

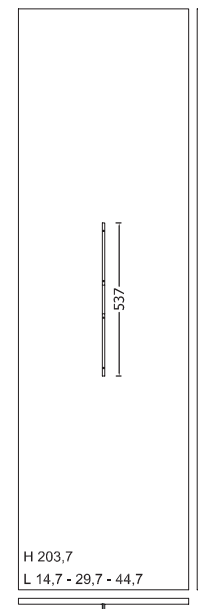

FRIGO - DISPENSA 1 ANTA
 COLUMN FRIDGE - CABINET

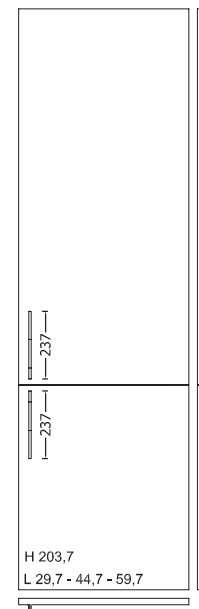

COLONNA FORNO
 COLUMN OVEN

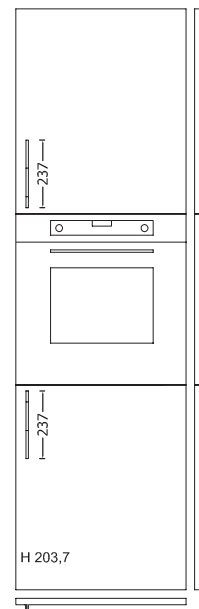

MANIGLIA ORIZZONTALE M42

M42 HANDLE HORIZONTAL



Maniglia M42 finitura nichel satinata
 passo in funzione dell'anta
 Handle M42 nickel satin finish
 centre-to-centre distance varies according to the door

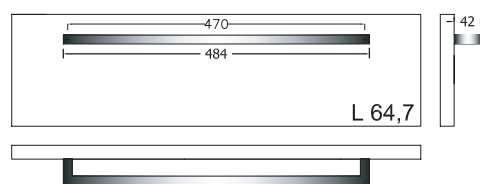
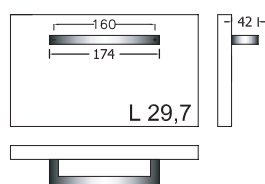
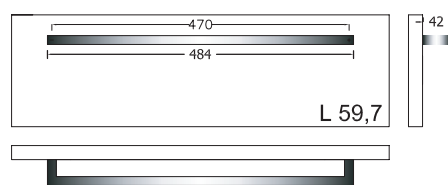
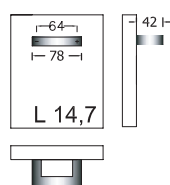

ANGOLO PENSILE A LIBRO
 corner wall unit folding

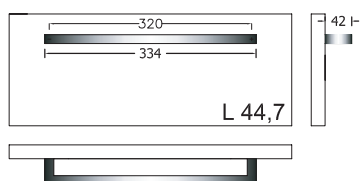
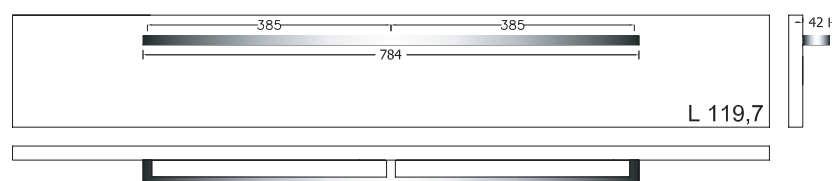
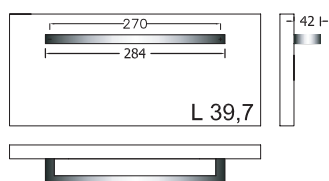
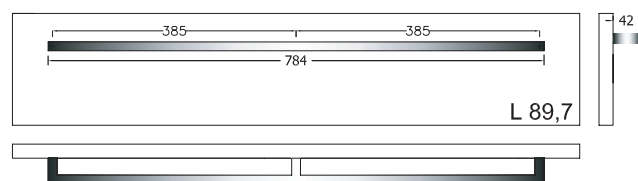
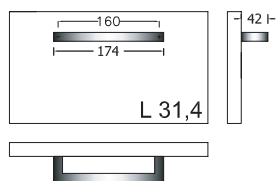

MANIGLIA ORIZZONTALE M41

M41 HANDLE HORIZONTAL

Bridge



Maniglia M41 finitura ferro grezzo
passo in funzione dell'anta
Handle M41 unrefined iron finish
centre-to-centre distance varies according to the door

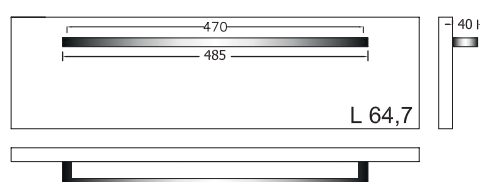
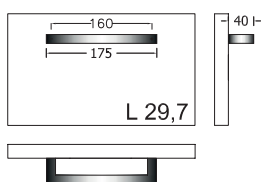
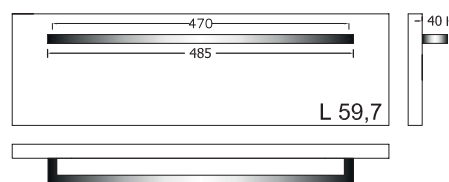
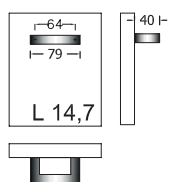

ANGOLO PENSILE A LIBRO
corner wall unit folding

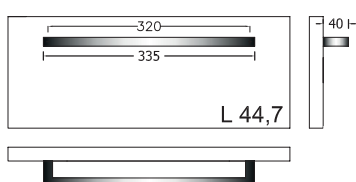
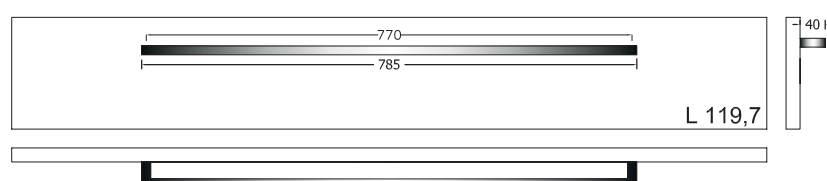
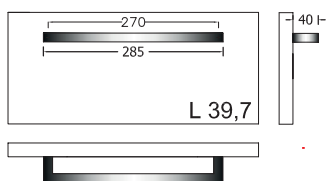
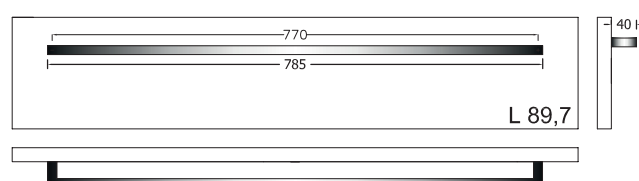
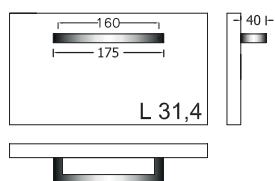

MANIGLIA VERTICALE M42V

M42V HANDLE VERTICAL

Bridge



Maniglia M42V finitura nichel satinata
 passo in funzione dell'anta
 Handle M42V nickel satin finish
 centre-to-centre distance varies according to the door

N.B.: la maniglia verticale non è disponibile per tutti gli elementi. Non inseribile su pensili, basi con cassetti e cestone
 Note: The vertical handle is not compatible with all the elements. Is not possible to insert it on the wall units and base units with drawers and deep drawers.

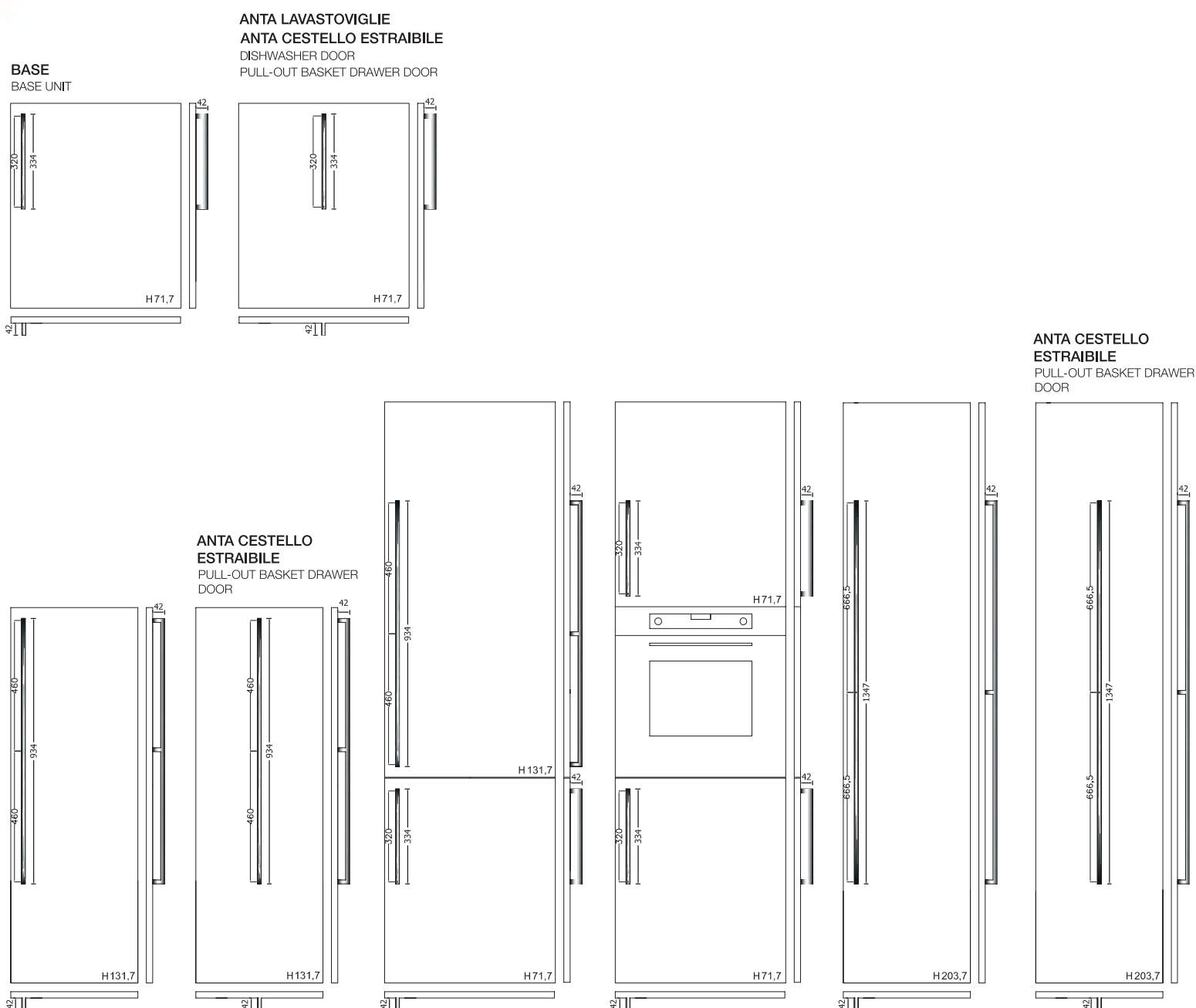

MANIGLIA VERTICALE M41V

M41V HANDLE VERTICAL



Maniglia M41V finitura ferro grezzo
 passo in funzione dell'anta
 Handle M41V unrefined iron finish
 centre-to-centre distance varies according to the door

N.B.: la maniglia verticale non è disponibile per tutti gli elementi. Non inseribile su pensili, basi con cassetti e cestone
Note: The vertical handle is not compatible with all the elements. Is not possible to insert it on the wall units and base units with drawers and deep drawers.

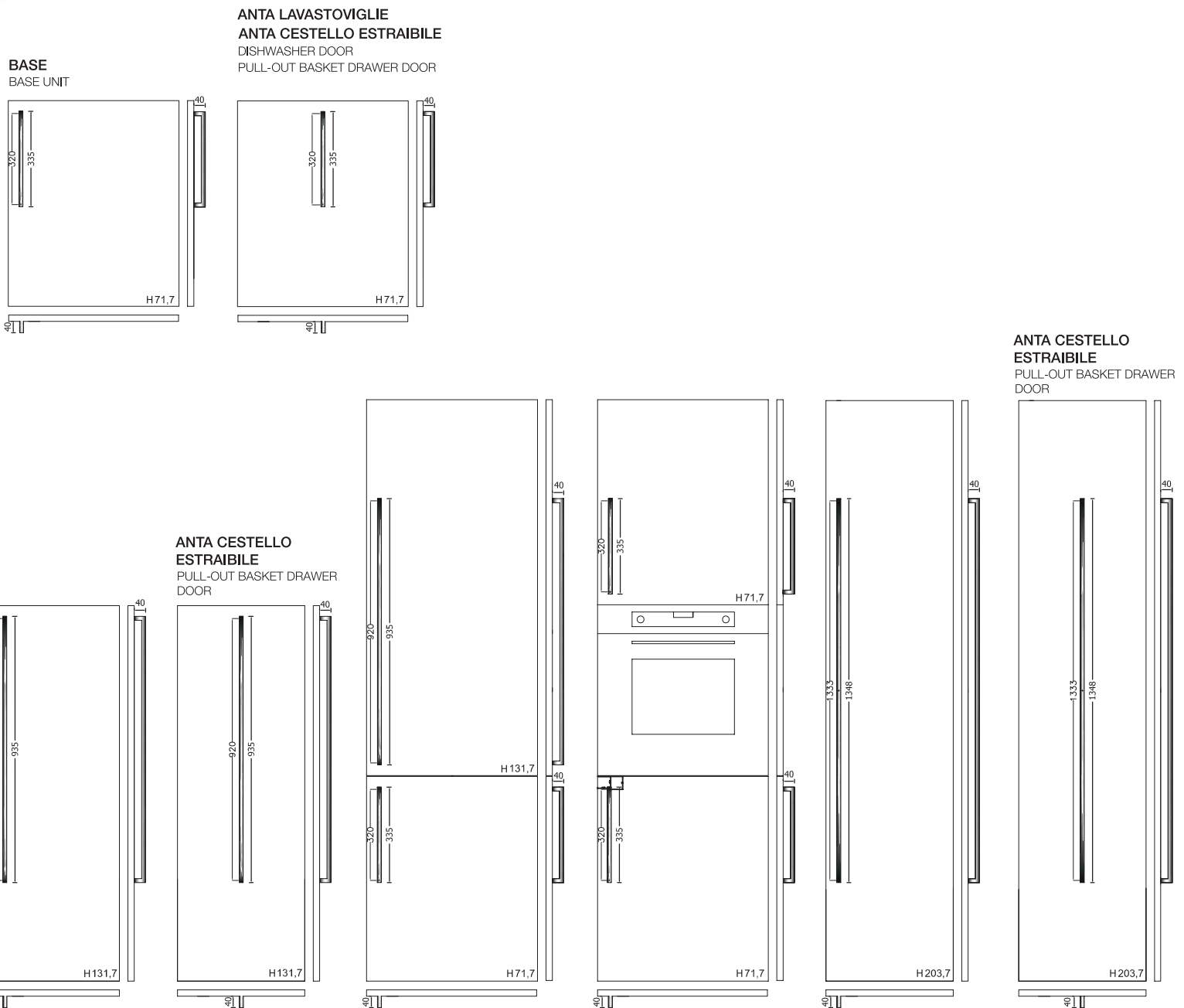

MANIGLIA ORIZZONTALE M60

M60 HANDLE HORIZONTAL

NEW

Bridge



Maniglia M60 finitura titanio
passo in funzione dell'anta

Handle M60 titanium finish
centre-to-centre distance varies according to the door

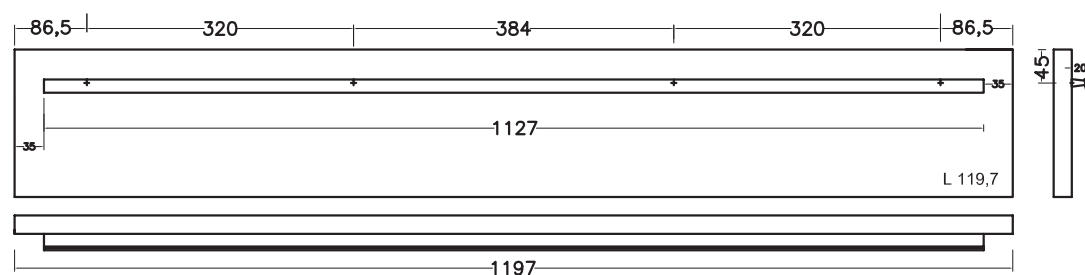
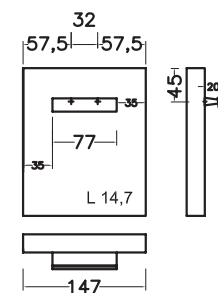
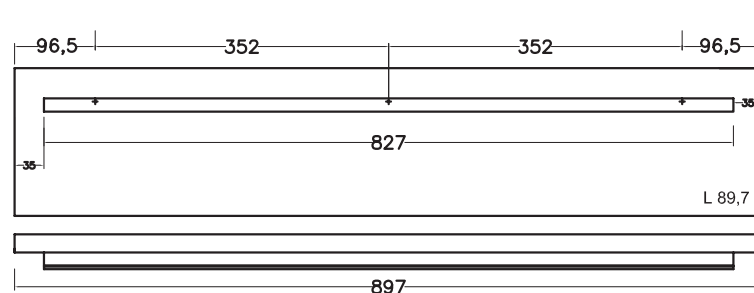
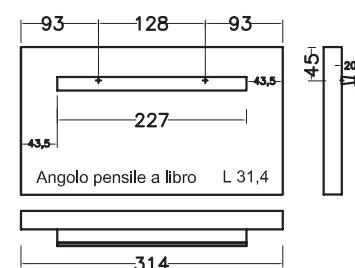
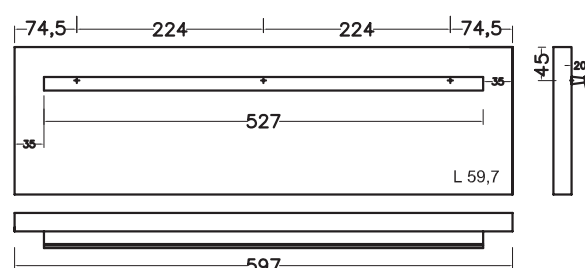
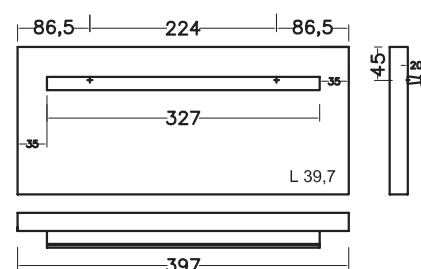
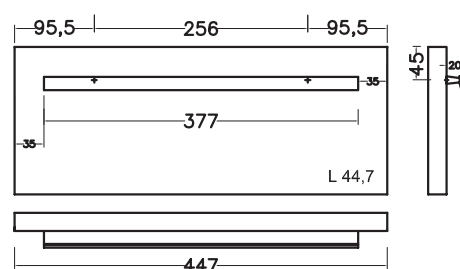
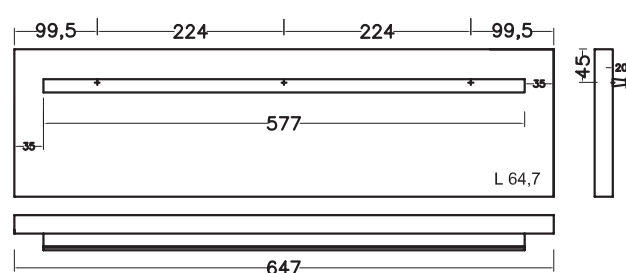
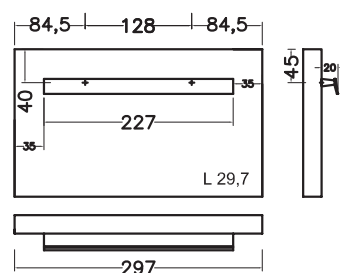

MANIGLIA APPLICATA IN TESTA

TOP-MOUNTED HANDLE

Bridge

N.B.: In presenza di questa maniglia non si possono tassativamente realizzare fuori misura in larghezza.
 Note: Custom-sized length elements cannot be realized using this handle.



Maniglia H52 finitura titanio

Handle H52 titanium finish

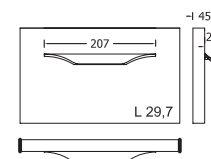
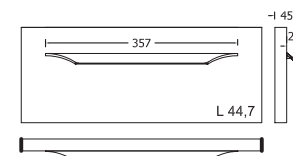
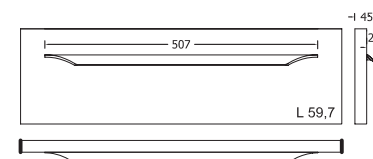
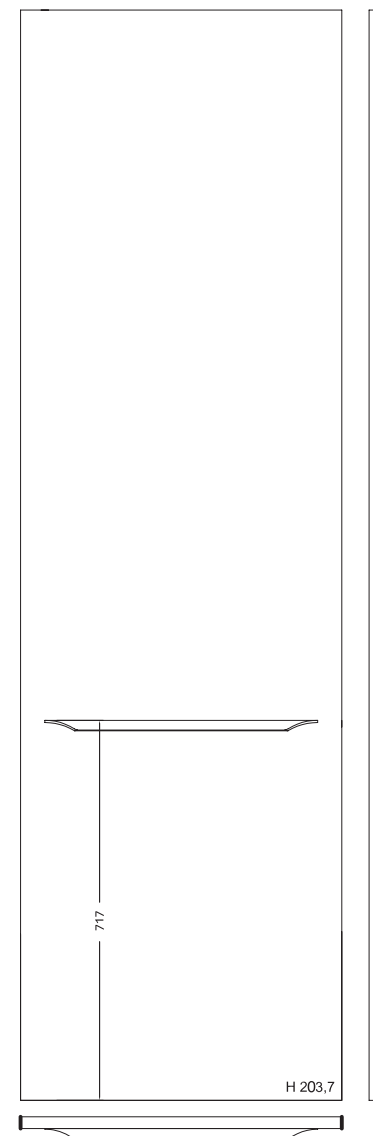
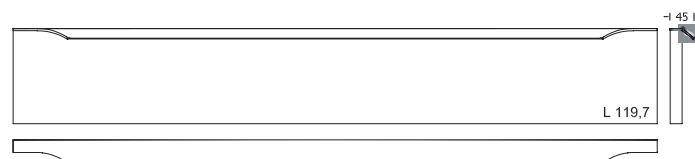
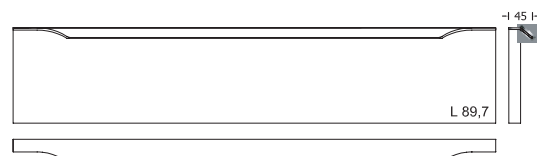
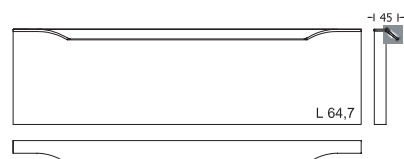
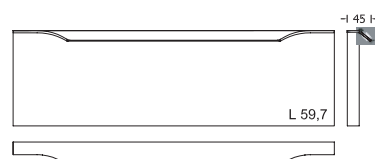
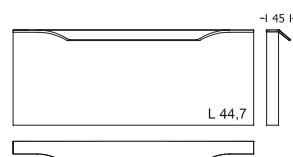
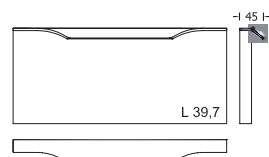
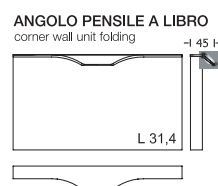
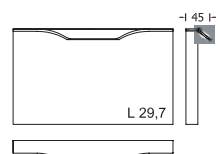
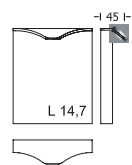



APERTURA A RIBALTA

Le ante aprendendosi verso l'alto consentono di avere un' ampia visione d'insieme all'interno del mobile.

La regolazione della forza di apertura può essere impostata in modo esatto in base al peso del frontale. Grazie all'arresto progressivo le ante si fermano in qualsiasi posizione; in questo modo la maniglia è sempre facilmente raggiungibile. La chiusura è ammortizzata e un'unica manovra è sufficiente per regolare il frontale tridimensionalmente grazie all'assenza di cerniere e al sistema di aggancio clip.

WALL UNIT WITH FLAP DOOR

The doors that open upwards guarantee ample overall visibility inside the cabinet.

The opening force can be adjusted precisely according to the weight of the front. The doors stop in any position thanks to the gradual stopping movement; in this way, the handle is always easily accessible. The closing movement is cushioned and a single manoeuvre is required to three-dimensionally adjust the front, thanks to the clip-on system and the absence of hinges.



DI SERIE
STANDARD



MOTORIZZATO
SERVO-DRIVE
SERVO-DRIVE
MOTORISED
(Opz.007)

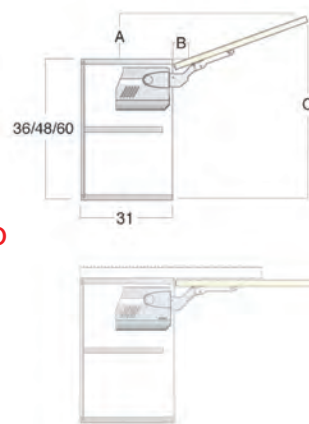

	A	B	C
H 36	11,5	3,5	37
H 48	15	3,5	49
H 60	18,5	3,5	61

Per evitare l'interferenza dell'anta in fase di apertura con cornici o mensole, si può richiedere il limitatore dell'angolo di apertura cod. 5620010

In order to avoid that the door interferes with cornices or shelves during the opening movement, it is possible to request an opening angle limiter: code 5620010

SCHEMA MONTAGGIO LIMITATORE PER RIBALTA H 36
FLAP DOOR LIMITER INSTALLATION DIAGRAM H 36

SCHEMA MONTAGGIO LIMITATORE PER RIBALTA H 48
FLAP DOOR LIMITER INSTALLATION DIAGRAM H 48

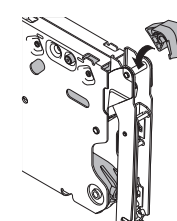
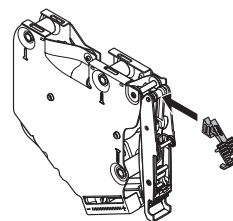

APERTURA VERTICALE OBLIQUA

I pensili con questo tipo di meccanismo necessitano per l'apertura di poco spazio libero sopra il mobile grazie al movimento basculante dell'anta che si apre senza difficoltà applicando poca forza anche in presenza di frontali pesanti. Con l'arresto progressivo le ante si fermano in qualsiasi posizione; in questo modo la maniglia è sempre facilmente raggiungibile. La chiusura è ammortizzata ed è possibile regolare la forza di tenuta in base al peso del frontale.

VERTICAL OPENING OBLIQUE

Wall units that mount this type of mechanism require little clearance above the cabinet thanks to the swivelling movement of the door that can be easily opened by applying slight pressure, even with heavy fronts. The doors stop in any position thanks to the gradual stopping movement; in this way, the handle is always easily accessible. The closing movement is cushioned and the closing force can be adjusted according to the weight of the front door.



DI SERIE
STANDARD



MOTORIZZATO
SERVO-DRIVE
SERVO-DRIVE
MOTORISED
(Opz.007)

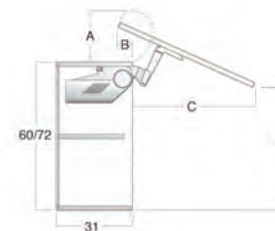

	A	B	C	D
H 60	18	9,6	46,5	53,5
H 72	18	9,6	57	61

APERTURA VERTICALE

L'anta ad apertura verticale, potendo essere sollevata completamente verso l'alto, consente un accesso totale all'interno del pensile. Ideale per l'impiego in mobili a colonna per nascondere ad esempio apparecchi elettrici, o pensili con corpi mobili sovrastanti, ha la chiusura ammortizzata e la possibilità di regolare la forza di tenuta in base al peso del frontale.

VERTICAL OPENING

Doors with vertical opening movement can be fully raised to fully access the inside of the wall unit.

Ideal for use on column units to conceal electrical appliances for examples, or on wall units surmounted by mobile units.

The closing movement is cushioned and the closing force can be adjusted according to the weight of the front door.



**DI SERIE
STANDARD**

**MOTORIZZATO
SERVO-DRIVE**
SERVO-DRIVE
MOTORISED
(Opz.007)

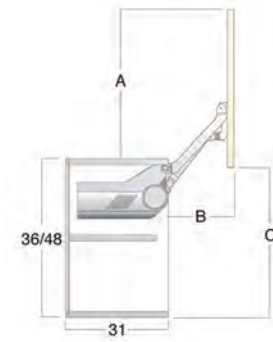

	A	B	C
H 36	34	23,5	34,5
H 48	43	28,5	43,5

APERTURA ANTE A PACCHETTO

Il meccanismo d'apertura ante a pacchetto è idoneo sul pensile H 72; la regolazione della forza di apertura può essere impostata in modo esatto in base ai pesi dei frontali, la chiusura è ammortizzata e la cerniera centrale clip si contraddistingue per l'innovativa tecnologia che garantisce la sicurezza per le dita.

LIFT-UP FOLDING DOORS

The lift-up folding door opening mechanism is suitable for wall units with H 72; the opening force can be adjusted precisely according to the weight of the fronts, while the closing movement is cushioned and the central clip-on hinge features innovative technology for safeguarding the fingers.



**DI SERIE
STANDARD**

**MOTORIZZATO
SERVO-DRIVE**
SERVO-DRIVE
MOTORISED
(Opz.007)

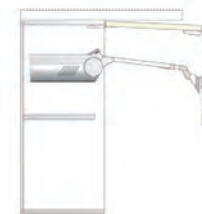
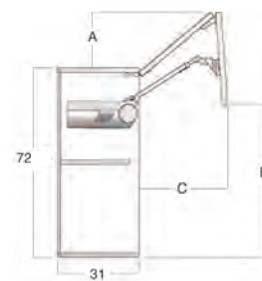

	A	B	C
H 72	16,5	54	41

**SCHEMA MONTAGGIO
LIMITATORE**
LIMITER INSTALLATION
DIAGRAM

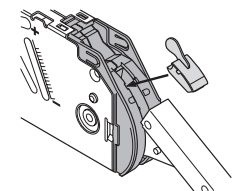

Per evitare l'interferenza dell'anta in fase di apertura con cornici o mensole, si può richiedere il limitatore dell'angolo di apertura cod. 5620005

In order to avoid that the door interferes with cornices or shelves during the opening movement, it is possible to request an opening angle limiter: code 5620005

COMPOSIZIONE CON ELEMENTI INCLINATI

COMPOSITION WITH INCLINED ELEMENTS

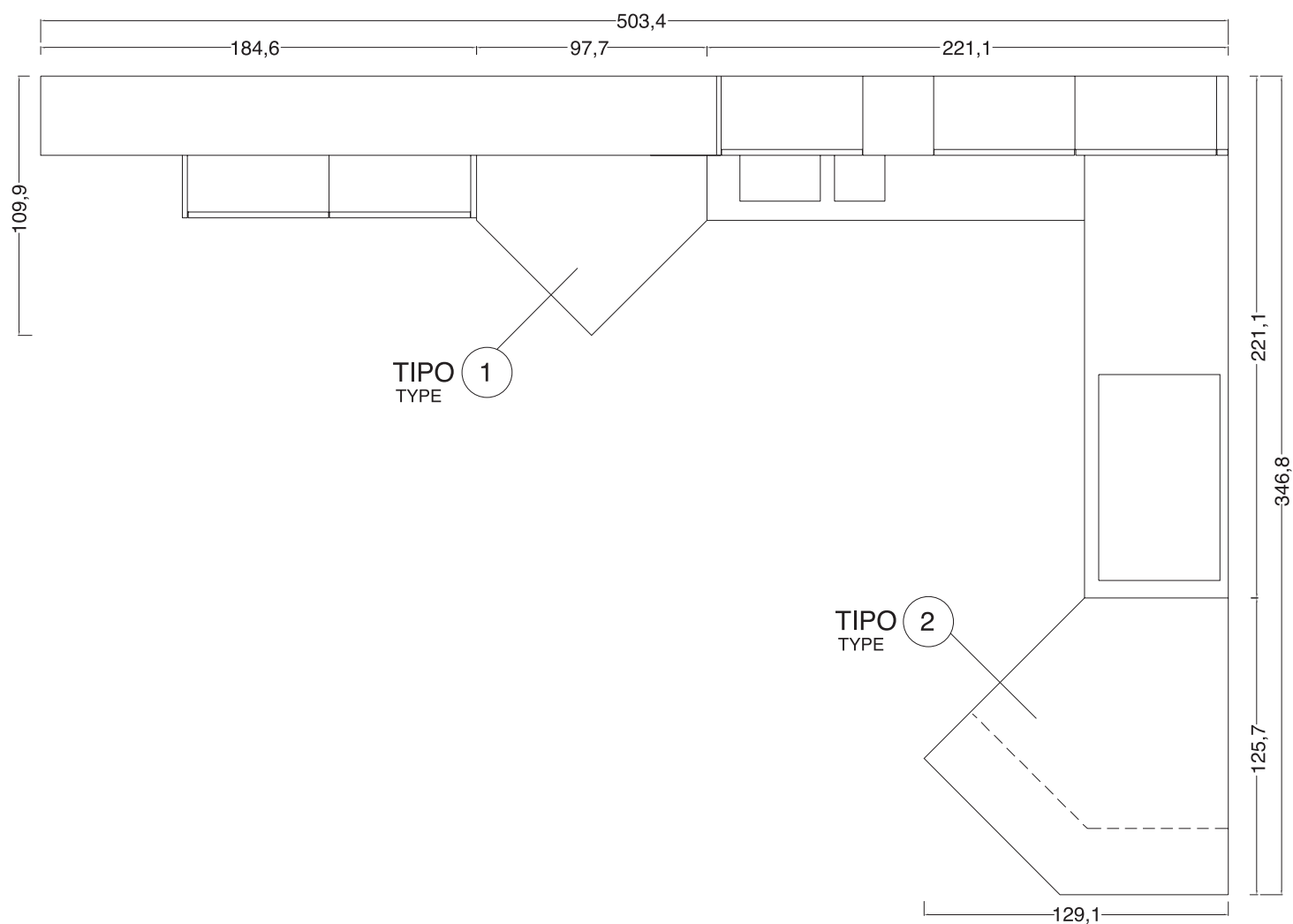
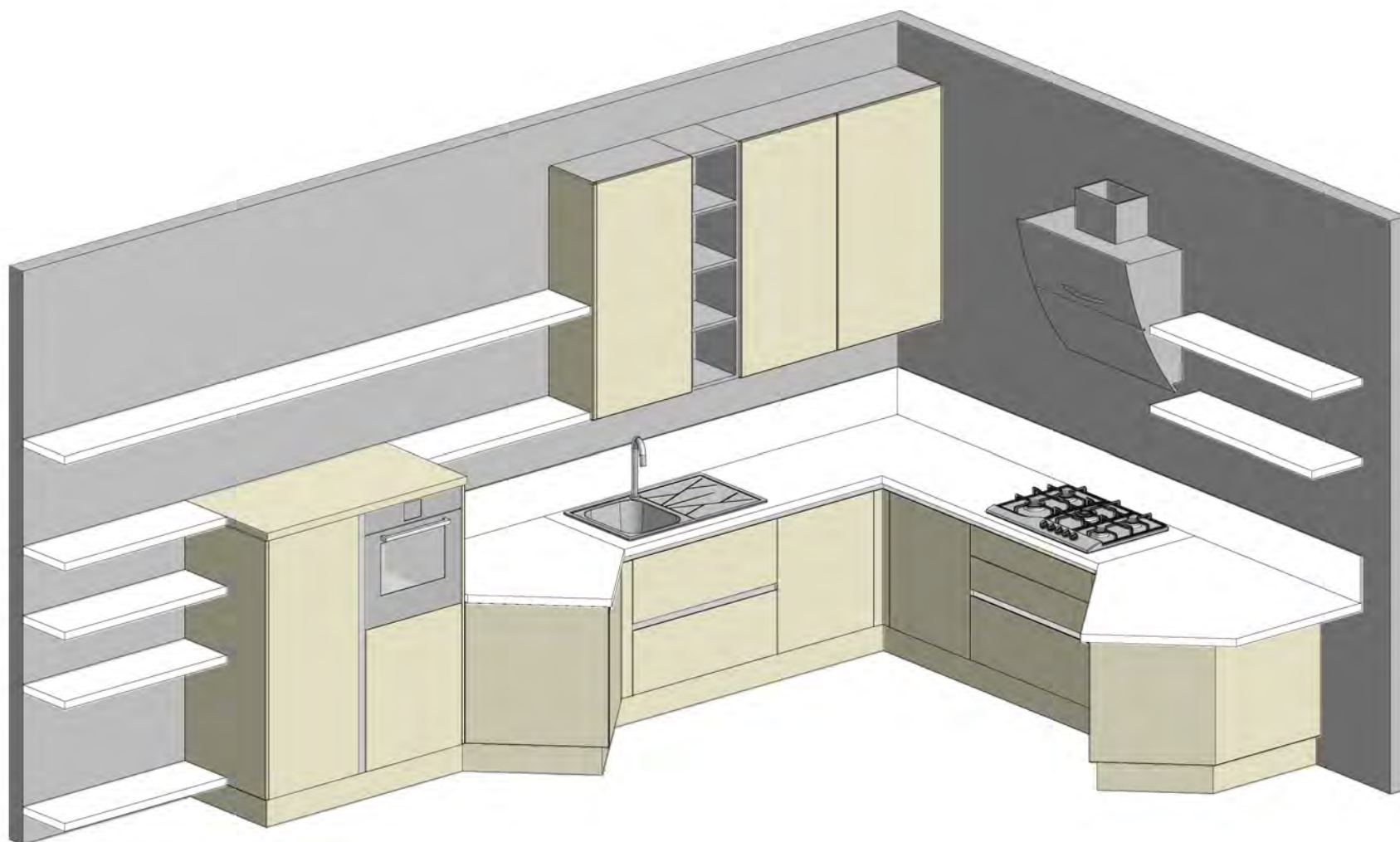



COLONNE ARMADIO “NOOK” H 217 P 70,4 CON ANTE A SCOMPARSA

“NOOK” CLOSET COLUMNS H 217 D 70,4 WITH DOORS INWARDS

Le colonne armadio “Nook” con ante a scomparsa, consentono di inserire all’interno forno, frigo, tavolo e cassetti

“Nook” closet columns with pull-out doors allow to insert oven, fridge, table and drawer on the inside



COLONNE ARMADIO "NOOK" H 217 P 70,4 CON ANTE A SCOMPARSA

"NOOK" CLOSET COLUMNS H 217 D 70,4 WITH DOORS INWARDS

Il tavolo estraibile è disponibile nella versione inox o in laminato, nella finitura oak cognac

The pull-out table it's available in stainless steel version or laminate oak cognac finish



COLONNA 180 H 217 P 70,4 CON ANTE COMPLANARI

COLUMN 180 H 217 D 70,4 WITH SLIDING DOORS



COLONNA 180 H 217 P 70,4 CON ANTE COMPLANARI

COLUMN 180 H 217 D 70,4 WITH SLIDING DOORS

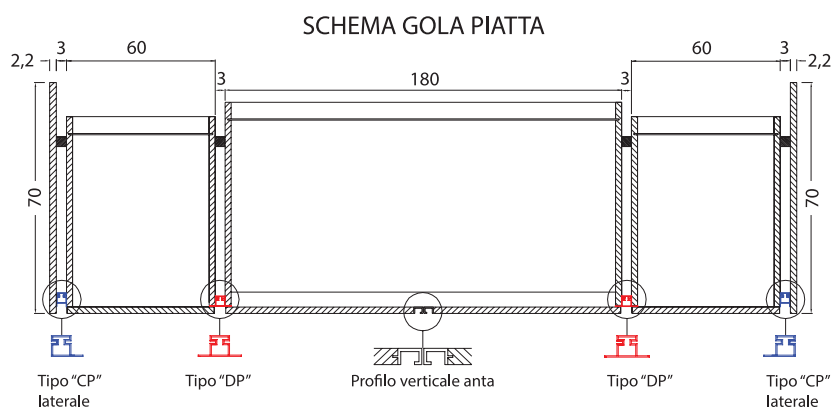
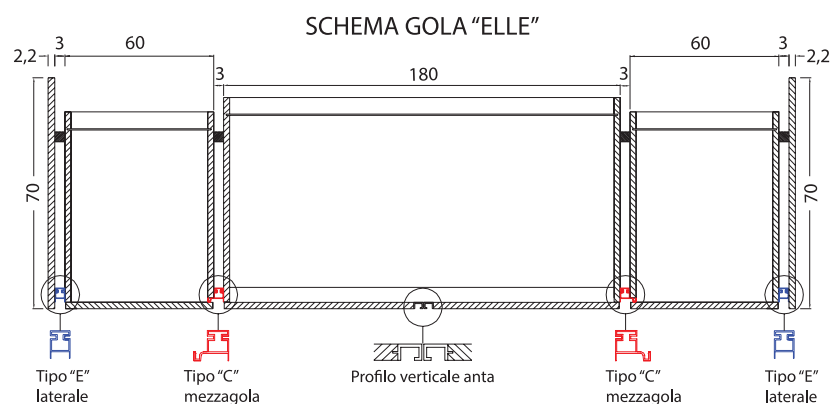
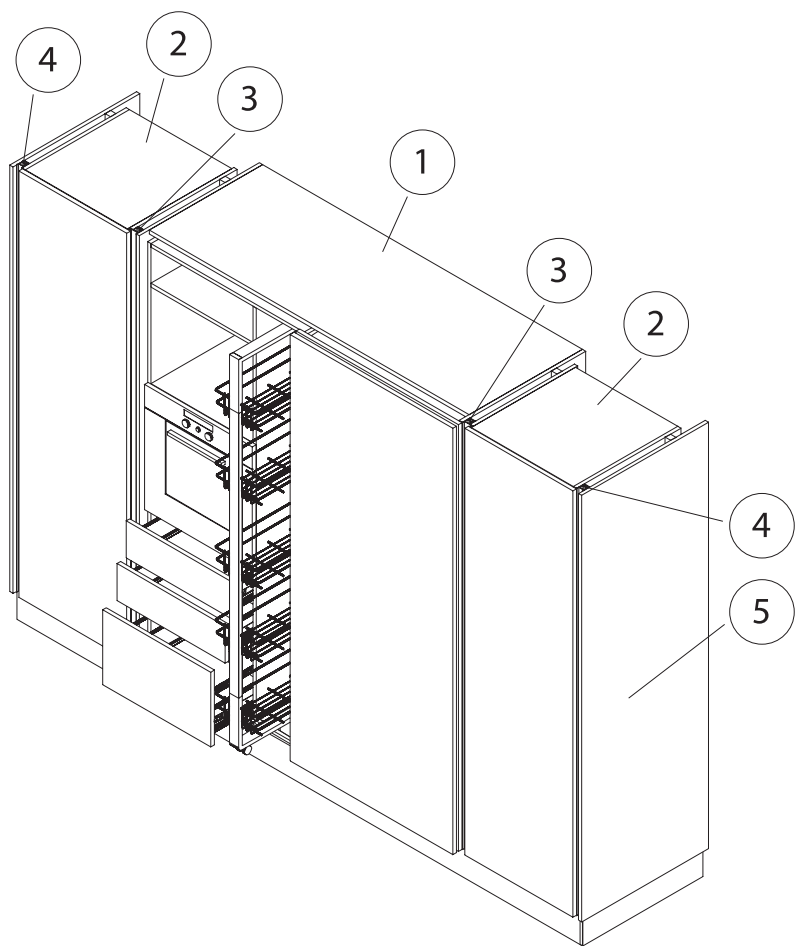

ANTE CON PROFILO VERTICALE EFFETTO GOLA
DOORS WITH VERTICAL PROFILE, FINGER RAIL EFFECT

Composizione:
Composition:

- 1) colonna complanare 180 tipo "A"
column with sliding doors 180 type "A"
- 2) colonna dispensa da 60
pantry cabinet column W 60
- 3) gola H 204 tipo "C"
finger rail type "C" H 204
- gola H 204 tipo "CP"
finger rail type "CP" H 204
- 4) gola H 204 tipo "E"
finger rail type "E" H 204
- 5) fianco di finitura come anta 204x70,4
finishing side same colour as door 204x70,4

COD.														
G7501802														
G6061601														
G950350														
G960350														
G950550														
1XXX4115														

ELEMENTI CURVI

CURVED ELEMENTS



BASE CURVA 180°

180 ° CURVED BASE UNIT



BASE CURVA 360°

360° CURVED BASE UNIT



BASE ISOLA CURVA TIPO "D1"

TYPE "D1" CURVED ISLAND BASE UNIT

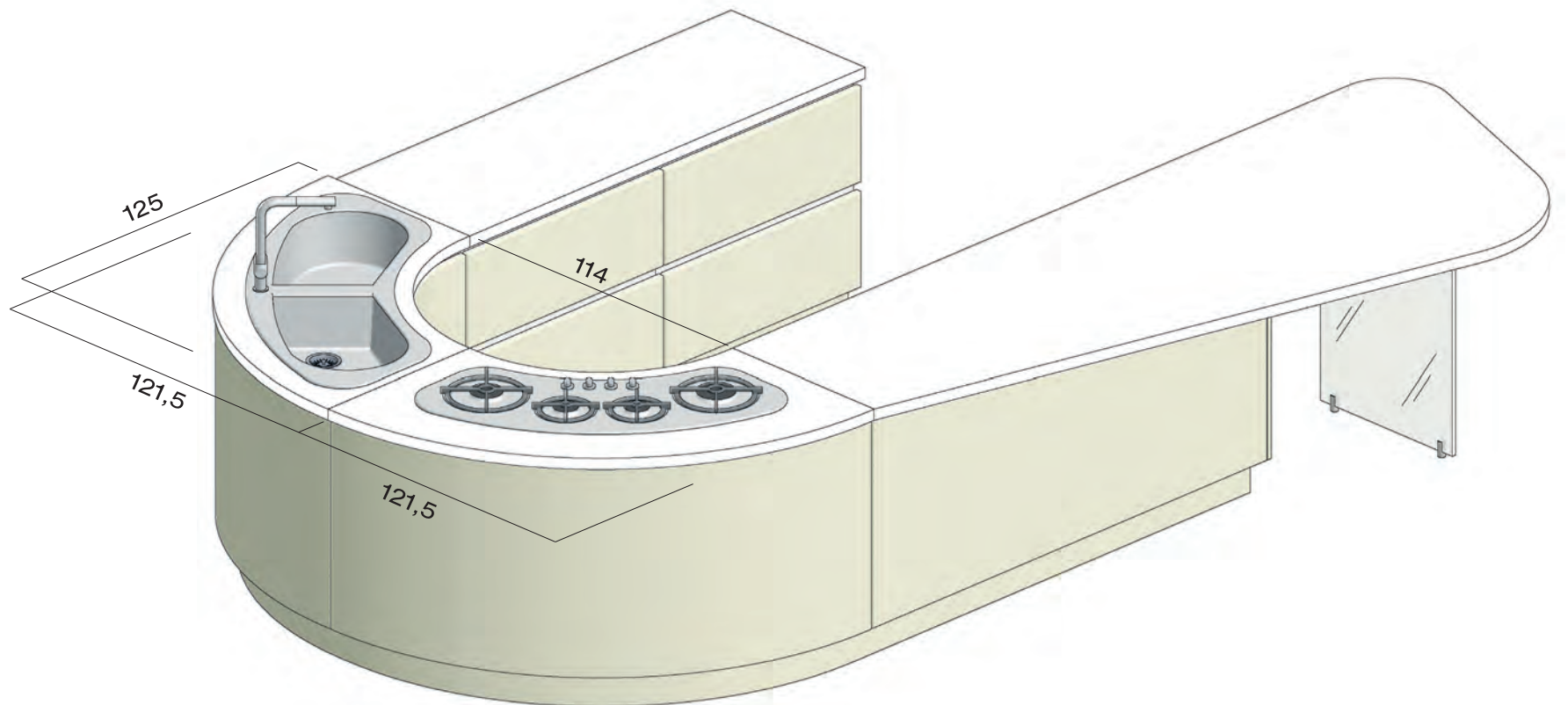





COMPOSIZIONE CON ELEMENTI INCLINATI

COMPOSITION WITH INCLINED ELEMENTS

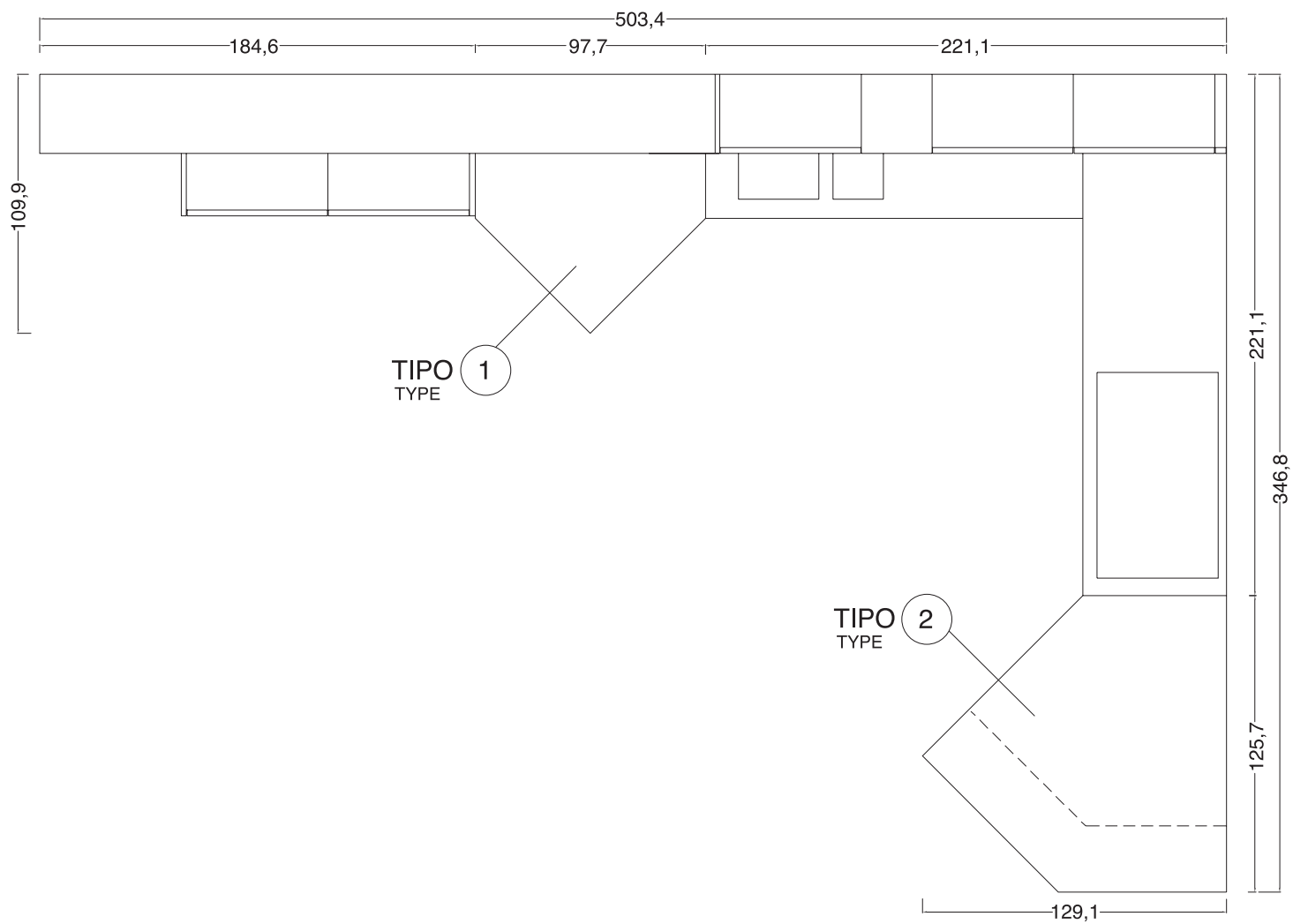
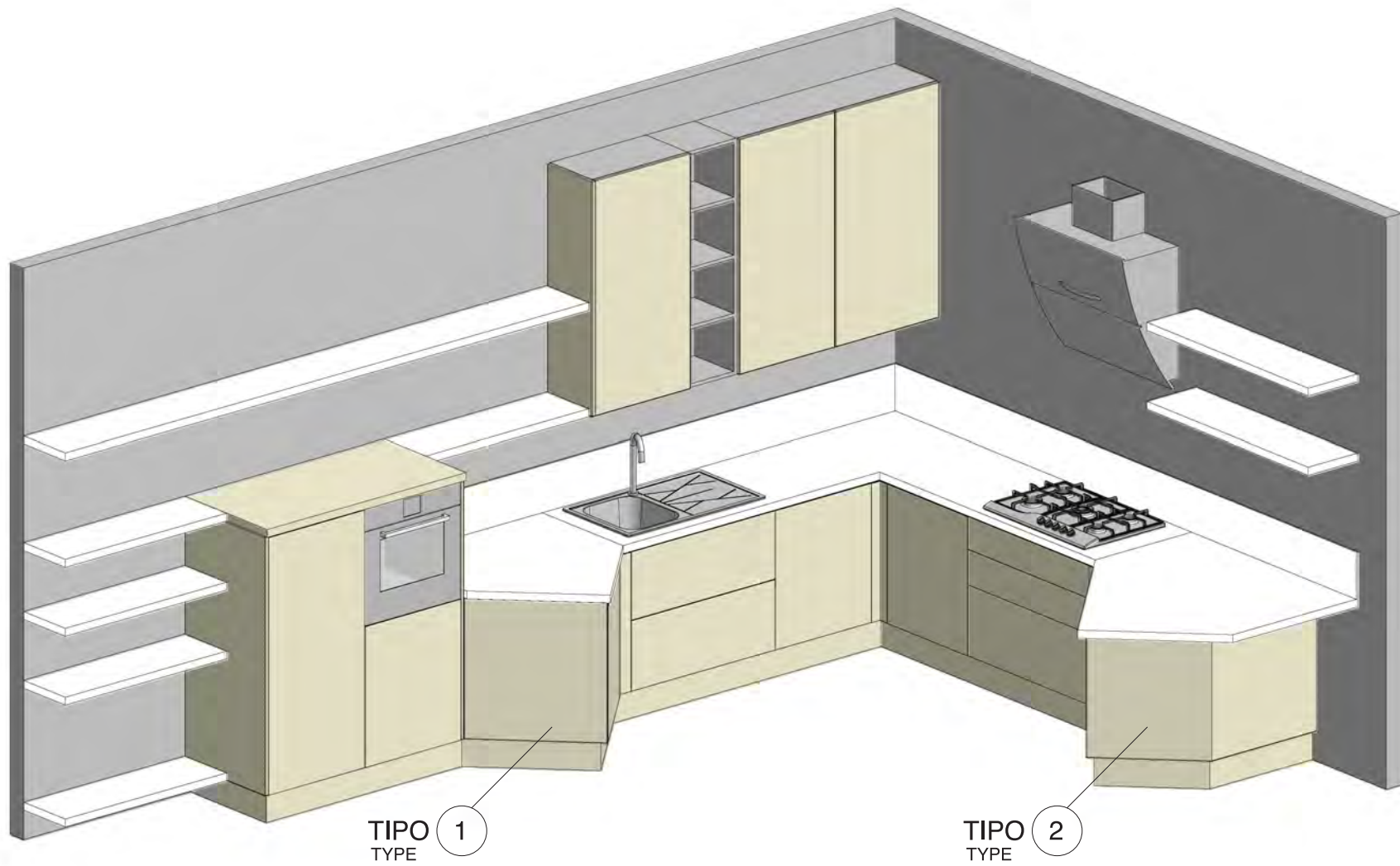

COLONNA 180 H 217 P 70,4 CON ANTE COMPLANARI

COLUMN 180 H 217 D 70,4 WITH SLIDING DOORS



COLONNA 180 H 217 P 70,4 CON ANTE COMPLANARI

COLUMN 180 H 217 D 70,4 WITH SLIDING DOORS

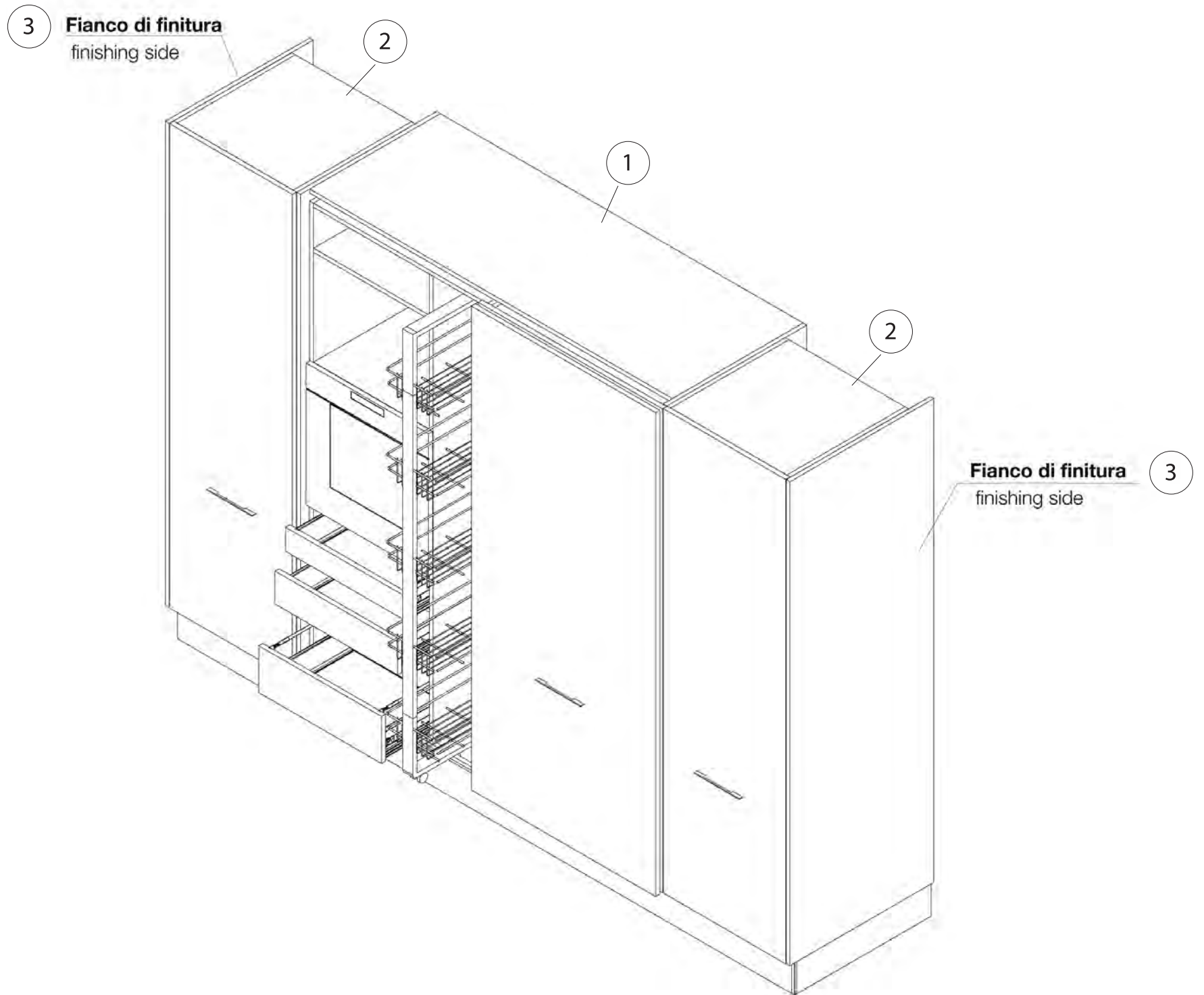

		COD.												
Composizione: Composition:	1) colonna complanare 180 tipo "A" column with sliding doors 180 type "A"	E7501802												
	2) colonna dispensa da 60 pantry cabinet column W 60	E6061601												
	3) fianco di finitura come anta 204x70,4 finishing side same colour as door 204x70,4	1XXX4115												



CABINA RIPOSTIGLIO

CLOSET COLUMN



ANTE VETRO
GLASS DOORS

[CLICCA QUI PER LA GAMMA DEI VETRI TELAIO ALLUMINIO](#)

[CLICK HERE FOR THE RANGE OF ALUMINIUM FRAMED GLASS](#)

COLORI STRUTTURA INTERNA IN NOBILITATO COLOURS FOR INTERNAL MELAMINE-COATED STRUCTURE

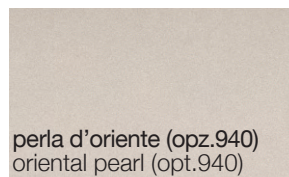
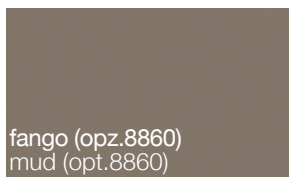
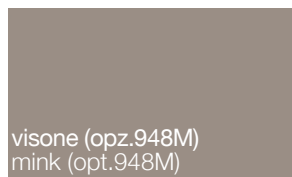
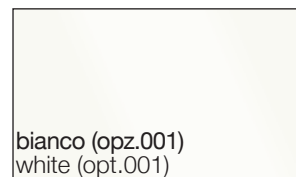

COLORI PANNELLI FISSI FRONTALE E LATERALE COLOURS FOR FIXED FRONT AND LATERAL PANELS



IMPIALLACCIATI **per colori vedi pag.10-11**
VENEERED **for colours see page 10-11**

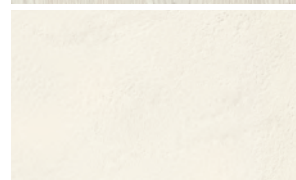

MALTA LACCATA OPACA **per colori vedi pag.13**
MATT LACQUERED MORTAR FINISH **for colours see page 13**

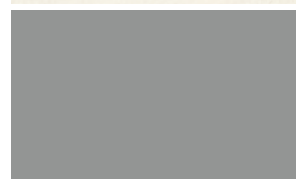

LACCATI OPACHI E LUCIDI **per colori vedi pag.16-17**
MATT AND GLOSSY LACQUERED **for colours see page 16-17**

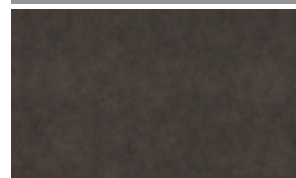

LACCATI VINTAGE EFFETTO METALLO **per colori vedi pag.19**
VINTAGE LACQUERED METAL EFFECT **for colours see page 19**



COLORI STRUTTURA INTERNA
INTERNAL CARCASS COLOURS

MELAMINICI
MELAMINE

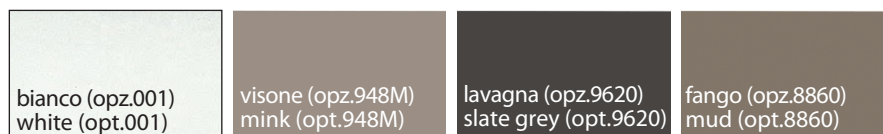

IMPIALLACCIATI per colori vedi pag.10-11
VENEERED for colours see page 10-11

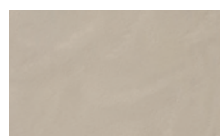

MALTA LACCATA OPACA per colori vedi pag.13
MATT LACQUERED MORTAR FINISH for colours see page 13



LACCATI OPACHI per colori vedi pag.16
MATT LACQUERED for colours see page 16

ELEMENTI A GIORNO IN LAMIERA VERNICIATI A POLVERE SP.2 MM

POWDER PAINTED METAL SHEET OPEN UNITS TH.2 MM



colori opachi
matt colours

<p>bianco assoluto (opz.740S) absolute white</p>	<p>castoro (opz.8907) beaver</p>	<p>acquamarina (opz.8323) aquamarine</p>	<p>giallo ambra (opz.8225) amber yellow</p>	<p>rosa quarzo (opz.8171) quartz pink</p>	<p>verde acqua (opz.8473) water green</p>
<p>blu fiordaliso (opz.8377) cornflower blue</p>	<p>salvia (opz.8443) sage</p>	<p>grigio bromo (opz.9533) bromine grey</p>	<p>bianco caldo (opz.7401) warm white</p>	<p>fumo (opz.9531) smoke</p>	<p>verde positano (opz.8471) positano green</p>
<p>nero (opz.7892) black</p>	<p>rosso toscano (opz.8157) tuscan red</p>	<p>titanio (opz.414V) titanium</p>		<p>blu cadetto (opz.8373) cadet blue</p>	<p>verde lichene (opz.8463) lichen green</p>
<p>argilla (opz.9503) clay</p>	<p>bistro (opz.9535) bistro</p>				

ELEMENTI A GIORNO SP. 14 MM

OPEN ELEMENTS TH.14 MM



COLORI IMPIALLACCIATI

VENEERED COLOURS

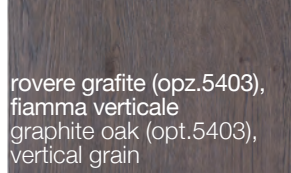
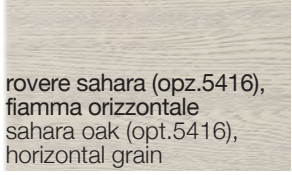
 <p>rovere grigio nebbia (opz.5401), fiamma verticale mist grey oak (opt.5401), vertical grain</p>	 <p>rovere polvere (opz.5402), fiamma verticale dust oak (opt.5402), vertical grain</p>	 <p>rovere grafite (opz.5403), fiamma verticale graphite oak (opt.5403), vertical grain</p>	 <p>rovere naturale (opz.5404), fiamma verticale natural oak (opt.5404), vertical grain</p>	 <p>rovere tabacco (opz.5405), fiamma verticale tobacco oak (opt.5405), vertical grain</p>	 <p>rovere bianco (opz.5415), fiamma orizzontale white oak (opt.5415), horizontal grain</p>
 <p>rovere sahara (opz.5416), fiamma orizzontale sahara oak (opt.5416), horizontal grain</p>	 <p>rovere visone (opz.5417), fiamma orizzontale mink oak (opt.5417), horizontal grain</p>	 <p>rovere grigio cenere (opz.5418), fiamma orizzontale ash grey oak (opt.5418), horizontal grain</p>	 <p>rovere lavagna (opz.5419), fiamma orizzontale slate grey oak (opt.5419), horizontal grain</p>	 <p>rovere nero (opz.5420), fiamma orizzontale black oak (opt.5420), horizontal grain</p>	
 <p>noce canaletto (opz.1324), fiamma verticale canaletto walnut (opt.1324), vertical grain</p>	 <p>rovere termocotto (opz.5410), fiamma verticale thermo-treated oak (opt.5410), vertical grain</p>				

COLORI LACCATI OPACHI

MATT LACQUERED COLOURS

 [CLICCA QUI PER LA GAMMA COLORI DISPONIBILI](#)

 [CLICK HERE FOR THE RANGE OF AVAILABLE COLORS](#)

SCHIENALI "SHELF" CON MENSOLE IN LAMIERA VERNICIATA

"SHELF" BACK PANELS WITH PAINTED METAL SHEET SHELVES



colori opachi mensole e montanti
matt colours for shelves and stiles

<p>bianco assoluto (opz.740S) absolute white</p>	<p>castoro (opz.8907) beaver</p>	<p>acquamarina (opz.8323) aquamarine</p>	<p>giallo ambra (opz.8225) amber yellow</p>	<p>rosa quarzo (opz.8171) quartz pink</p>	<p>verde acqua (opz.8473) water green</p>
<p>blu fiordaliso (opz.8377) cornflower blue</p>	<p>salvia (opz.8443) sage</p>	<p>grigio bromo (opz.9533) bromine grey</p>	<p>bianco caldo (opz.7401) warm white</p>	<p>fumo (opz.9531) smoke</p>	<p>verde positano (opz.8471) positano green</p>
<p>nero (opz.7892) black</p>	<p>rosso toscano (opz.8157) tuscan red</p>	<p>titanio (opz.414V) titanium</p>		<p>blu cadetto (opz.8373) cadet blue</p>	<p>verde lichene (opz.8463) lichen green</p>
<p>argilla (opz.9503) clay</p>	<p>bistro (opz.9535) bistro</p>				

COLORI SCHIENALI

COLOURS FOR BACK PANELS

SCHIENALE IMPIALLACCIATO

VENEERED BACK PANEL



SCHIENALE MALTA LACCATO OPACO

MALTA MATT LACQUERED BACK PANEL



SCHIENALE LACCATO OPACO

MATT LACQUERED BACK PANEL

COLORI FREDDI OPACHI SOFT SOFT MATT COLD COLOURS

COLORI CALDI OPACHI SOFT SOFT MATT HOT COLOURS

 [CLICCA QUI PER LA GAMMA COLORI DISPONIBILI](#)

 [CLICK HERE FOR THE RANGE OF AVAILABLE COLORS](#)

SCHIENALI "WEAVE" CON MENSOLE LACCATE OPACHE

"WEAVE" BACK PANELS WITH MATT LACQUERED SHELVES



colori opachi per mensole
matt colours for shelves

<p>grigio kenya (opz.9501) kenya grey (opt.9501)</p>	<p>castoro (opz.8907) beaver (opt.8907)</p>	<p>verde positano (opz.8471) positano green (opt.8471)</p>	<p>grigio bromo (opz.9533) bromine grey (opt.9533)</p>	<p>bianco caldo (opz.7401) warm white (opt.7401)</p>	<p>fumo (opz.9531) smoke (opt.9531)</p>
<p>rosso toscano (opz.8157) tuscan red (opt.8157)</p>	<p>blu fiordaliso (opz.8377) cornflower blue (opt.8377)</p>	<p>argilla (opz.9503) clay (opt.9503)</p>	<p>nero (opz.7892) black (opt.7892)</p>		

COLORI SCHIENALI

COLOURS FOR BACK PANELS

SCHIENALE IMPIALLACCIATO

VENEERED BACK PANEL



SCHIENALE LACCATO OPACO

MATT LACQUERED BACK PANEL

COLORI FREDDI OPACHI SOFT SOFT MATT COLD COLOURS

COLORI CALDI OPACHI SOFT SOFT MATT HOT COLOURS

 [CLICCA QUI PER LA GAMMA COLORI DISPONIBILI](#)

 [CLICK HERE FOR THE RANGE OF AVAILABLE COLORS](#)



SCHIENALI E MENSOLE CON LUCI

BACK PANELS AND SHELVES WITH LIGHTS



SCHIENALI E MENSOLE CON LUCI

BACK PANELS AND SHELVES WITH LIGHTS

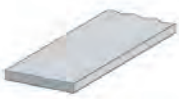
	COD.									
 <p>schienale SP. 2,2 colore come anta, con attaccaglie back panel Th. 2,2 same colour as door with hangers</p>										
	<p>impiallacciato al mq veneered per m²</p> <p>laccato al mq lacquered per m²</p>	09452C								
 <p>mensola SP. 3,8 P 28,8 finitura come anta shelf Th. 3,8 D 28,8 same finish as door</p>										
	<p>impiallacciato al ml veneered per lm</p> <p>laccato al ml lacquered per lm</p>	0917225								
	<p>maggiorazione x incasso luce surcharge for built-in light</p>	T9ILU								



luce DIVA HE TLD Domus Line
DIVA HE TLD light Domus Line



Installazione

DIVA HE TLD è un profilo minimale ad incasso in battuta per fresata di soli 12mm di profondità. Indicato per l'installazione sotto pensile e sottomensola DIVA HE TLD offre una proiezione luminosa simmetrica. Fornito di serie con cavo di alimentazione da 2000mm e connettore Micro12 integra un interruttore elettronico TouchLed che al "tocco" accende, spegne e regola l'intensità luminosa dell'apparecchio.

Installation

DIVA HE TLD is a narrow profile embedded in a milled groove which only needs to be 12mm deep. It is recommended for the installation under cabinets or shelves and it offers a symmetric lighting projection. It comes with a 2000mm supply cable and Micro12 connector. DIVA HE TLD incorporates an electronic TouchLed switch that with a simple touch switches on, turns off and adjust the luminous intensity of the device.

Codice - Code	Lunghezza - Length	Watt & Volt
08617040	376mm	3,24W @ 12Vdc
08617042	526mm	4,86W @ 12Vdc
08617044	826mm	8,10W @ 12Vdc
08617046	1126mm	11,34W @ 12Vdc

ALIMENTATORE NON COMPRESO. DA ORDINARE SEPARATAMENTE.
CONVERTER NOT INCLUDED. TO BE ORDERED SEPARATELY.

12Vdc

alimentare con Converter a tensione costante
feeding by constant voltage Converter



Micro 12



connettore polarizzato per apparecchi a 12Vdc
polarized connector for 12Vdc luminaire

HE

apparecchio a LED ad elevata densità lineare
luminaire with high linear density LED

DIVA HE TLD
con interruttore dimmerabile TouchLed
with dimmable TouchLed switch







Alimentatori consigliati - Suggested converters



FLAT 15/12R

Codice - Code	Watt & Volt
08617140	15W @ 12Vdc



SL30/12R

Codice - Code	Watt & Volt
08617142	30W @ 12Vdc



SL60/12R



Codice - Code	Watt & Volt
08617144	60W @ 12Vdc

ATTENZIONE! SCEGLIERE L'ALIMENTATORE DOPO AVER SOMMATO IL CONSUMO (WATT) DEI PROFILI SELEZIONATI. IL CONSUMO TOTALE NON DOVRÀ MAI SUPERARE LA MASSIMA PORTATA DELL'ALIMENTATORE.
ATTENTION! CHOOSE THE CONVERTER AFTER HAVE BEEN ADD TOGETHER THE CONSUMPTION (WATT) OF THE SELECTED PROFILES. THE TOTAL CONSUMPTION CAN NEVER EXCEED THE MAXIMUM LOAD OF THE CONVERTER.

SCHIENALE PORTA TV CON LUCE POSTERIORE

TV HOLDER BACK PANEL WITH REAR LIGHT



		COD.								
 <p>schienale L 110 H 108 sp. 2,2 colore come anta con luce led posteriore su 3 lati (superiore e laterali) back panel W 110 H 108 Th. 2,2 same colour as door with rear led light on 3 sides (upper and lateral)</p>	L 110	E82910110								
 <p>schienale L 120 H 108 sp. 2,2 colore come anta con luce led posteriore su 3 lati (superiore e laterali) back panel W 120 H 108 Th. 2,2 same colour as door with rear led light on 3 sides (upper and lateral)</p>	L 120	E82910120								

COLORI SCHIENALI

COLOURS FOR BACK PANELS

SCHIENALE IMPIALLACCIATO

VENEERED BACK PANEL



SCHIENALE MALTA LACCATO OPACO

MALTA MATT LACQUERED BACK PANEL



SCHIENALE LACCATO OPACO

MATT LACQUERED BACK PANEL

COLORI FREDDI OPACHI SOFT SOFT MATT COLD COLOURS

COLORI CALDI OPACHI SOFT SOFT MATT HOT COLOURS

 [CLICCA QUI PER LA GAMMA COLORI DISPONIBILI](#)

 [CLICK HERE FOR THE RANGE OF AVAILABLE COLORS](#)

VETRINA COMPONIBILE CON SCHIENA E PIEDINI IN TINTA CON L'ANTA

MODULAR DISPLAY CABINET WITH BACK PANEL AND FEET SAME COLOUR AS DOOR



COLORI VETRI GLASS COLOURS

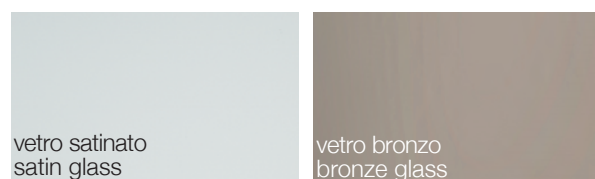

vetro satinato
satin glass

vetro bronzo
bronze glass

COLORI IMPIALLACCIATI VENEERED COLOURS

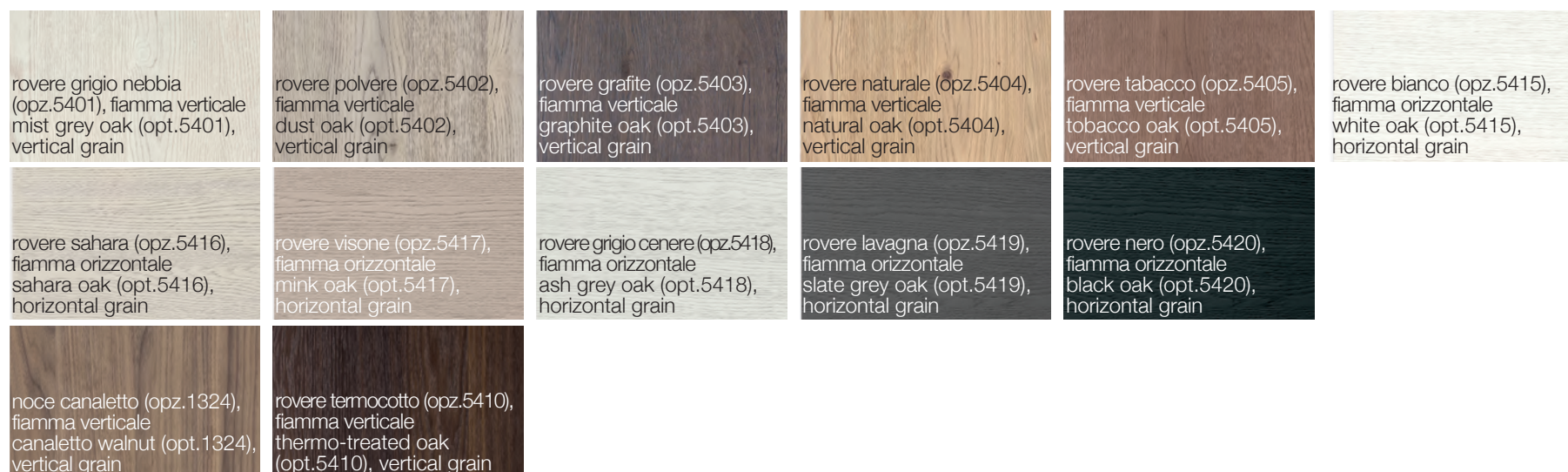

rovere grigio nebbia (opz.5401), fiamma verticale
mist grey oak (opt.5401), vertical grain

rovere polvere (opz.5402), fiamma verticale
dust oak (opt.5402), vertical grain

rovere grafite (opz.5403), fiamma verticale
graphite oak (opt.5403), vertical grain

rovere naturale (opz.5404), fiamma verticale
natural oak (opt.5404), vertical grain

rovere tabacco (opz.5405), fiamma verticale
tobacco oak (opt.5405), vertical grain

rovere bianco (opz.5415), fiamma orizzontale
white oak (opt.5415), horizontal grain

rovere sahara (opz.5416), fiamma orizzontale
sahara oak (opt.5416), horizontal grain

rovere visone (opz.5417), fiamma orizzontale
mink oak (opt.5417), horizontal grain

rovere grigio cenere (opz.5418), fiamma orizzontale
ash grey oak (opt.5418), horizontal grain

rovere lavagna (opz.5419), fiamma orizzontale
slate grey oak (opt.5419), horizontal grain

rovere nero (opz.5420), fiamma orizzontale
black oak (opt.5420), horizontal grain

noce canaletto (opz.1324), fiamma verticale
canaletto walnut (opt.1324), vertical grain

rovere termocotto (opz.5410), fiamma verticale
thermo-treated oak (opt.5410), vertical grain

COLORI LACCATI VINTAGE EFFETTO METALLO LACQUERED VINTAGE COLOURS METAL EFFECT

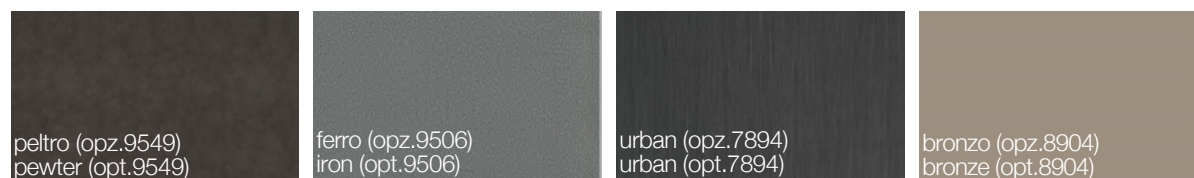

peltro (opz.9549)
pewter (opt.9549)

ferro (opz.9506)
iron (opt.9506)

urban (opz.7894)
urban (opt.7894)

bronzo (opz.8904)
bronze (opt.8904)

MOBILI LIVING "PLAN" COMPONENTI

"PLAN" LIVING MODULAR FURNITURE



FINITURE ELEMENTI A GIORNO PER MOBILI LIVING “PLAN”

FINISHES FOR “PLAN” LIVING OPEN UNITS

COLORI IMPIALLACCIATI

VENEERED COLOURS

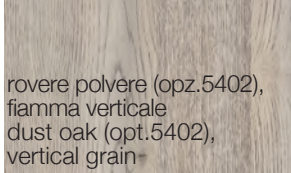
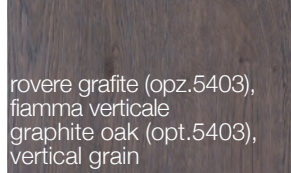
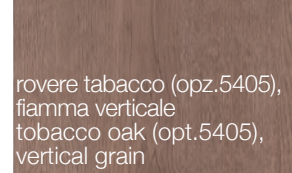
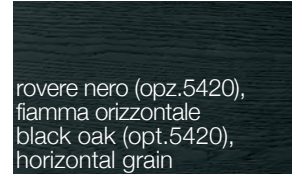
 <p>rovere grigio nebbia (opz.5401), fiamma verticale mist grey oak (opt.5401), vertical grain</p>	 <p>rovere polvere (opz.5402), fiamma verticale dust oak (opt.5402), vertical grain</p>	 <p>rovere grafite (opz.5403), fiamma verticale graphite oak (opt.5403), vertical grain</p>	 <p>rovere naturale (opz.5404), fiamma verticale natural oak (opt.5404), vertical grain</p>	 <p>rovere tabacco (opz.5405), fiamma verticale tobacco oak (opt.5405), vertical grain</p>	 <p>rovere bianco (opz.5415), fiamma orizzontale white oak (opt.5415), horizontal grain</p>
 <p>rovere sahara (opz.5416), fiamma orizzontale sahara oak (opt.5416), horizontal grain</p>	 <p>rovere visone (opz.5417), fiamma orizzontale mink oak (opt.5417), horizontal grain</p>	 <p>rovere grigio cenere (opz.5418), fiamma orizzontale ash grey oak (opt.5418), horizontal grain</p>	 <p>rovere lavagna (opz.5419), fiamma orizzontale slate grey oak (opt.5419), horizontal grain</p>	 <p>rovere nero (opz.5420), fiamma orizzontale black oak (opt.5420), horizontal grain</p>	
 <p>noce canaletto (opz.1324), fiamma verticale canaletto walnut (opt.1324), vertical grain</p>	 <p>rovere termocotto (opz.5410), fiamma verticale thermo-treated oak (opt.5410), vertical grain</p>				

COLORI LACCATI OPACHI

MATT LACQUERED COLOURS

 <p>grigio kenya (opz.9501) kenya grey (opt.9501)</p>	 <p>verde positano (opz.8471) positano green (opt.8471)</p>	 <p>grigio bromo (opz.9533) bromine grey (opt.9533)</p>	 <p>bianco caldo (opz.7401) warm white (opt.7401)</p>	 <p>fumo (opz.9531) smoke (opt.9531)</p>
 <p>rosso toscano (opz.8157) tuscan red (opt.8157)</p>	 <p>blu fiordaliso (opz.8377) cornflower blue (opt.8377)</p>	 <p>castoro (opz.8907) beaver (opt.8907)</p>	 <p>argilla (opz.9503) clay (opt.9503)</p>	 <p>nero (opz.7892) black (opt.7892)</p>

VIVI IL LIVING

LIVE THE LIVING

Vasta gamma di soluzioni e totale modularità per creare nuove composizioni living adatte ad ogni spazio.

Wide range of solutions and totaly of modules to create new lively furnishing compositions suitable for every kind of space.



LIBRERIA LIVING

LIVING BOOKCASE

La libreria va ad ampliare la gamma living con spessore e carattere. La sua struttura sp.2,5 è perfettamente coordinata alla cucina grazie alla possibilità di integrare le ante del programma Clover.

N.B.: per una corretta preventivazione ed ordine delle librerie, si consiglia l'uso del programma 3cad Evolution

The bookcase expands the living range with substance and character. His th. 2,5 structure is perfectly coordinated with the kitchen, thanks to the possibility to integrate the door finishes of Clover program.

Note: we recommend to use the 3cad Evolution software, for having a correct estimate and order.

FINITURE STRUTTURA SP.2,5 - SCHIENA SP.1

STRUCTURE FINISHES TH.2,5 - BACK PANEL TH.1

MELAMINICO
melamine

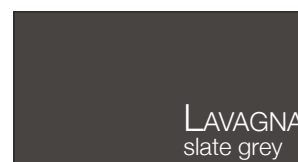
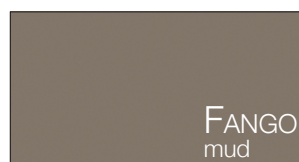

LACCATO OPACO
matt lacquered

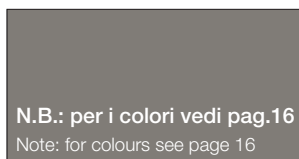

FINITURE ANTE

DOORS FINISHES

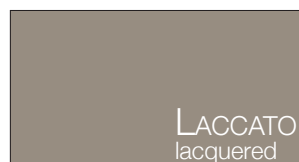
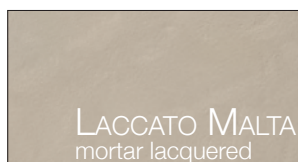
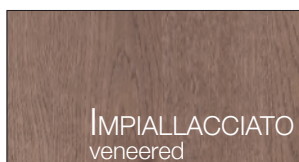

LIVING LC 01



ANTE
doors

IMPIALLACCIATO
veneered

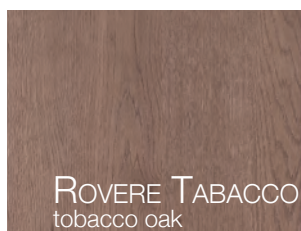

VETRO
glass



STRUTTURA
carcass

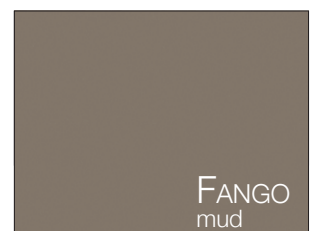

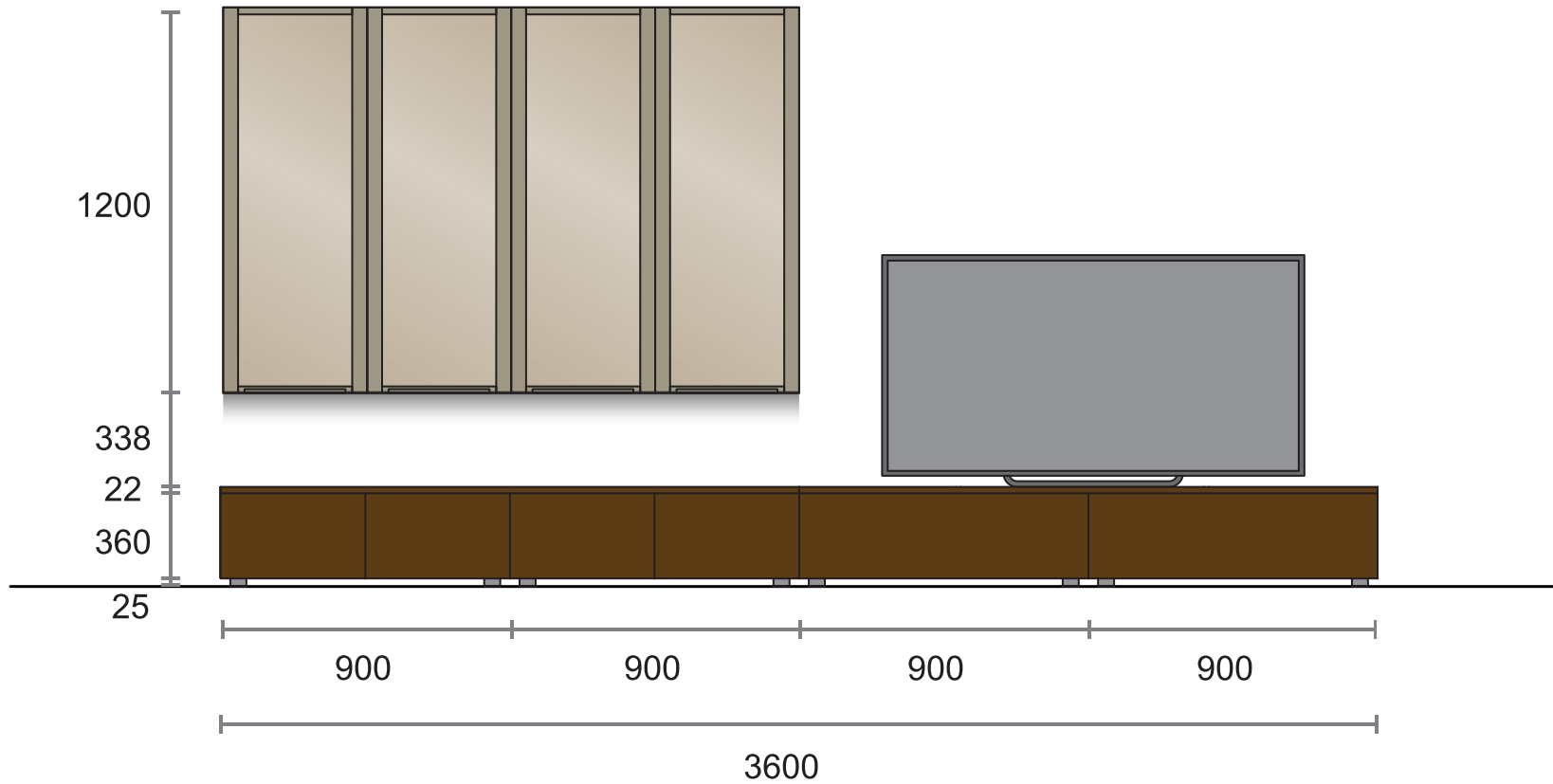

NR. ELEMENTI	DESCRIZIONE	CODICE
2	Pensile vetro telaio alluminio L 45 H 120 P 33,4 con presa maniglia	E1023451/2
2	Pensile vetro telaio alluminio L 45 H 120 P 33,4 con presa maniglia, 1 fianco come anta	E1023451/2
1	Base living L 90 H 38,5 P 50,4 2 ante apertura push-pull, fianco come anta	EBL21900
1	Base living L 90 H 38,5 P 50,4 2 ante apertura push-pull	EBL21900
1	Base living L 90 H 38,5 P 50,4 1 cestone apertura tip-on, fianco come anta	EBL25900
1	Base living L 90 H 38,5 P 50,4 1 cestone apertura tip-on	EBL25900
2	Top impiallacciato L 180 P 50,4 SP. 2,2	al ml TLH225
1	Asta appendipensili ml 2	08610501
No. of ELEMENTS	DESCRIPTION	CODE
2	Glass door wall unit with aluminium frame W 45 H 120 D 33,4 with handle	E1023451/2
2	Glass door wall unit with aluminium frame W 45 H 120 D 33,4 with handle, 1 side same as door	E1023451/2
1	Living base unit W 90 H 38,5 D 50,4 2 doors with push-pull opening, side same as door	EBL21900
1	Living base unit W 90 H 38,5 D 50,4 2 doors with push-pull opening	EBL21900
1	Living base unit W 90 H 38,5 D 50,4 1 deep drawer with tip-on opening, side same as door	EBL25900
1	Living base unit W 90 H 38,5 D 50,4 1 deep drawer with tip-on opening	EBL25900
2	Veneered worktop W 180 D 50,4 TH. 2,2	per lm TLH225
1	Wall unit fixing strip lm 2	08610501

LIVING LC 02



ANTE
doors

ELEMENTI A GIORNO
open units

STRUTTURA
carcass

LACCATO OPACO
matt lacquered



LACCATO CON DECORO
lacquered with decoration



*finitura non disponibile

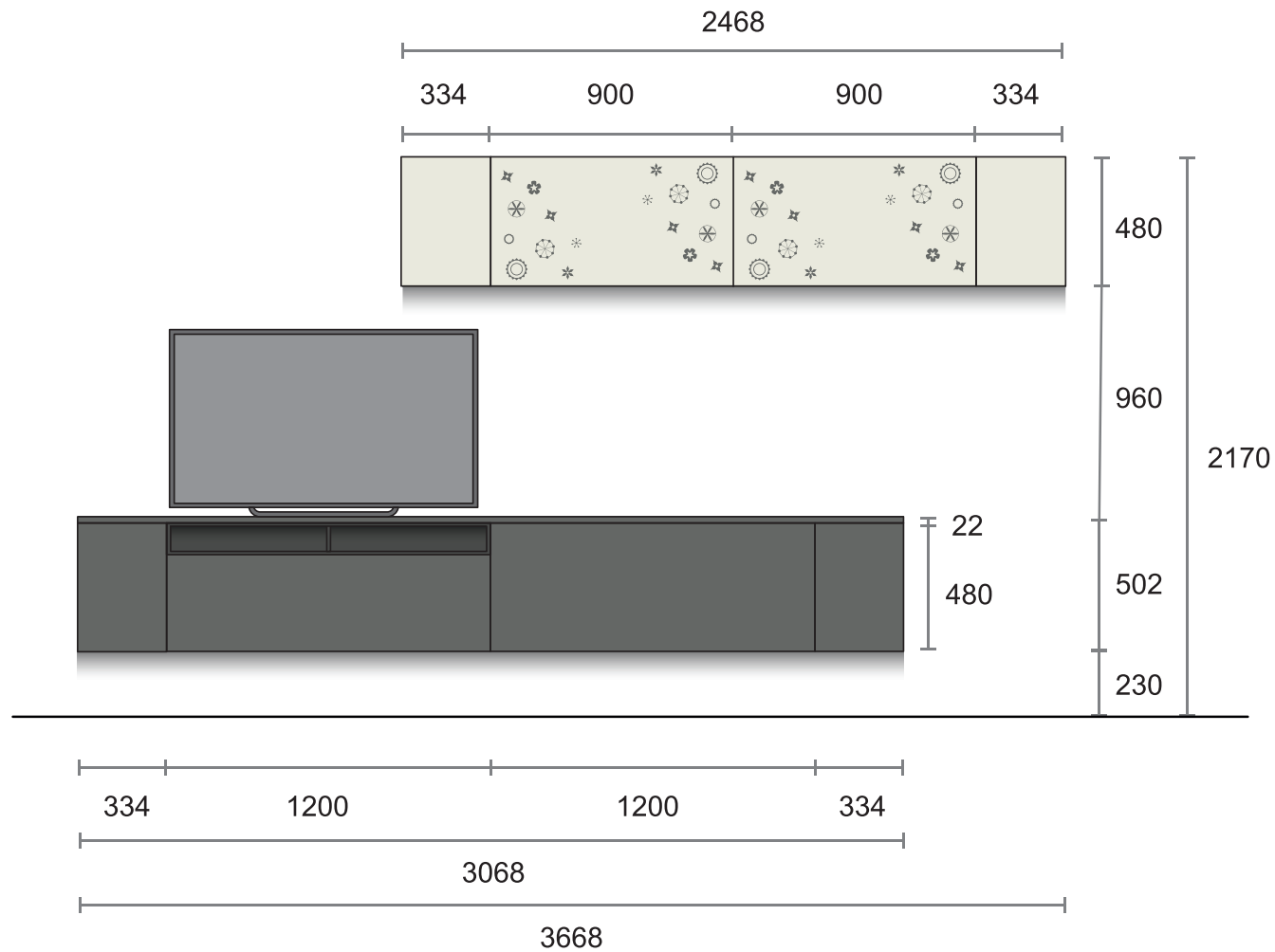

NR. ELEMENTI	DESCRIZIONE	CODICE
2	Terminale pensile curvo L 33,4 H 48 P 33,4 apertura push-pull	G2534311/2
2	Pensile L 90 H 48 P 33,4 ribalta con presa sul fondo	G2120900
2	Terminale base curvo sospeso L 33,4 H 48 P 50,4 apertura push-pull	EBTL1601/2
1	Base per decoder L 120 H 48 P 50,4 apertura vasistas	EBL87200
1	Base living sospesa L 120 H 48 P 50,4 1 cestone apertura tip-on	EBL86200
1	Top laccato L 306,8 P 50,4 SP. 2,2	al ml TLC225
2	Lavorazione stondatura top	T9STP
2	Asta appendipensili ml 2	08610501

No. of ELEMENTS	DESCRIPTION	CODE
2	Curved end wall unit W 33,4 H 48 D 33,4 push-pull opening	G2534311/2
2	Wall unit W 90 H 48 D 33,4 flap door with grip on bottom opening	G2120900
2	Suspended curved end base unit W 33,4 H 48 D 50,4 push-pull opening	EBTL1601/2
1	Decoder base unit W 120 H 48 D 50,4 flap door opening	EBL87200
1	Suspended living base unit W 120 H 48 D 50,4 1 deep drawer tip-on opening	EBL86200
1	Lacquered worktop W 306,8 D 50,4 TH. 2,2	per lm TLC225
2	Rounded worktop processing	T9STP
2	Wall unit fixing strip lm 2	08610501

LIVING LC 03



ANTE
doors

GRES LAMINAM
gres laminam

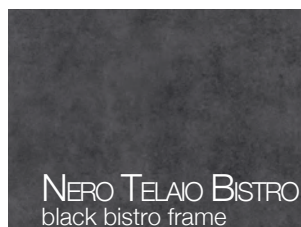

IMPIALLACCIATO
veneered



VETRO
glass



ELEMENTI A GIORNO
open units

LACCATO OPACO
matt lacquered



NOBILITATO
melamine-coated

STRUTTURA
carcass



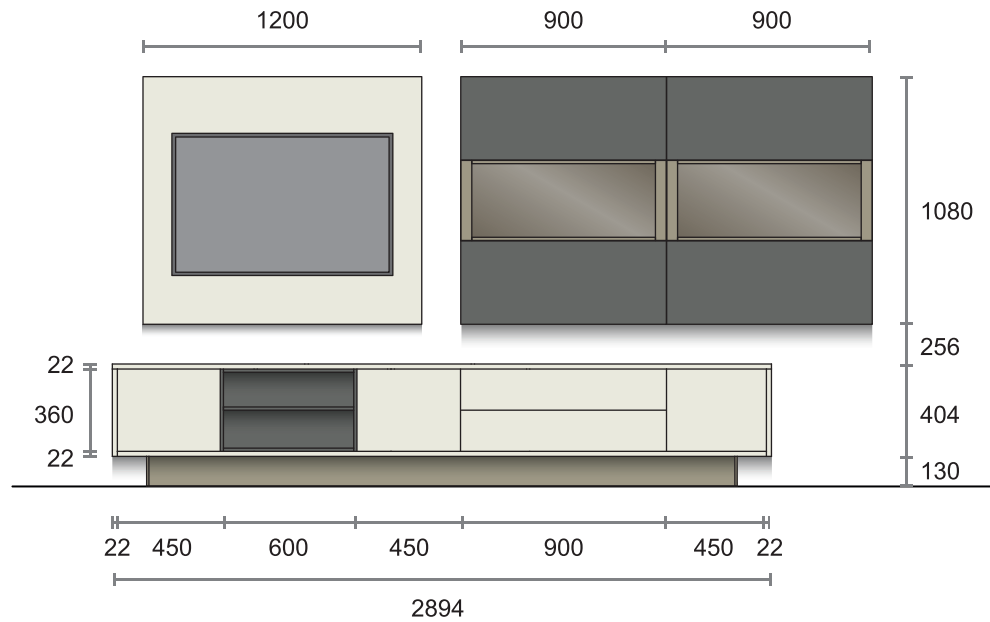

NR. ELEMENTI	DESCRIZIONE	CODICE
2	Pensile L 90 H 36 P 33,4 apertura tip-on	E210090T
2	Pensile vetro telaio alluminio L 90 H 36 P 33,4 apertura tip-on	G110290T
2	Pensile L 90 H 36 P 33,4 apertura vasistas con push-pull	E2106900
2	Coprifianco H 108 P 31 laccato opaco come anta	T98362
3	Base living "PLAN" in appoggio L 45 H 36 P 50,4 cestone, apertura tip-on	EBA35450
1	Base living "PLAN" in appoggio L 90 H 36 P 50,4 2 cassetti H 18, apertura tip-on	EBA33900
1	Elemento a giorno in appoggio L 60 H 36 2 vani, laccato opaco	E7702415
1	Top living "PLAN" superiore L 289,4 P 50,4 SP. 2,2 impiallacciato come anta al ml	TLHP225
1	Top living "PLAN" inferiore L 285 P 50,4 SP. 2,2 impiallacciato come anta al ml	TLHP225
2	Fianco living P 50,4 H 38,2 SP. 2,2 impiallacciato come anta al ml	TLHP225F
1	Basamento in ferro L 269,4 H 13 P 40,4 nella finitura titanio al ml	T92541
1	Elemento porta tv L 120 H 108 SP. 2,2 impiallacciato come anta con luci led	E82910120
3	Asta appendipensili ml 2	08610501

No. of ELEMENTS	DESCRIPTION	CODE
2	Wall unit W 90 H 36 D 33,4 tip-on opening	E210090T
2	Wall unit W 90 H 36 D 33,4 door with aluminium frame tip-on opening	G110290T
2	Wall unit W 90 H 36 D 33,4 flap door with push-pull opening	E2106900
2	Matt lacquered side panel H 108 D 31, same colour as door	T98362
3	Lay on "PLAN" living base unit W 45 H 36 D 50,4 deep drawer tip-on opening	EBA35450
1	Lay on "PLAN" living base unit W 90 H 36 D 50,4 2 drawers H 18 tip-on opening	EBA33900
1	Lay on matt lacquered open element W 60 H 36 with 2 compartments	E7702415
1	Veneered "PLAN" upper living worktop W 289,4 D 50,4 TH. 2,2 same colour as door per lm	TLHP225
1	Veneered "PLAN" lower living worktop W 285 D 50,4 TH. 2,2 same colour as door per lm	TLHP225
2	Veneered living side D 50,4 H 38,2 TH. 2,2 same colour as door per lm	TLHP225F
1	Iron basement W 269,4 H 13 D 40,4 titanium finish per lm	T92541
1	Tv holder back panel W 120 H 108 TH. 2,2 veneered same as door with incorporated led light	E82910120
3	Wall unit fixing strip lm 2	08610501

LIVING LC 04



ANTE
doors

GRES LAMINAM
gres laminam



IMPIALLACCIATO
veneered

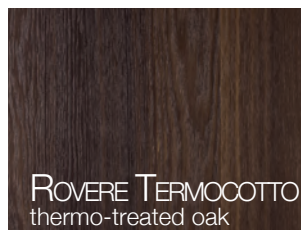

VETRO
glass



STRUTTURA
carcass

NOBILITATO
melamine-coated

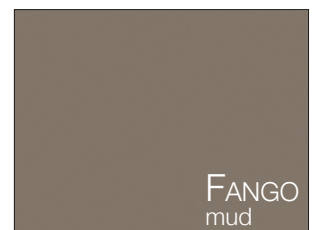

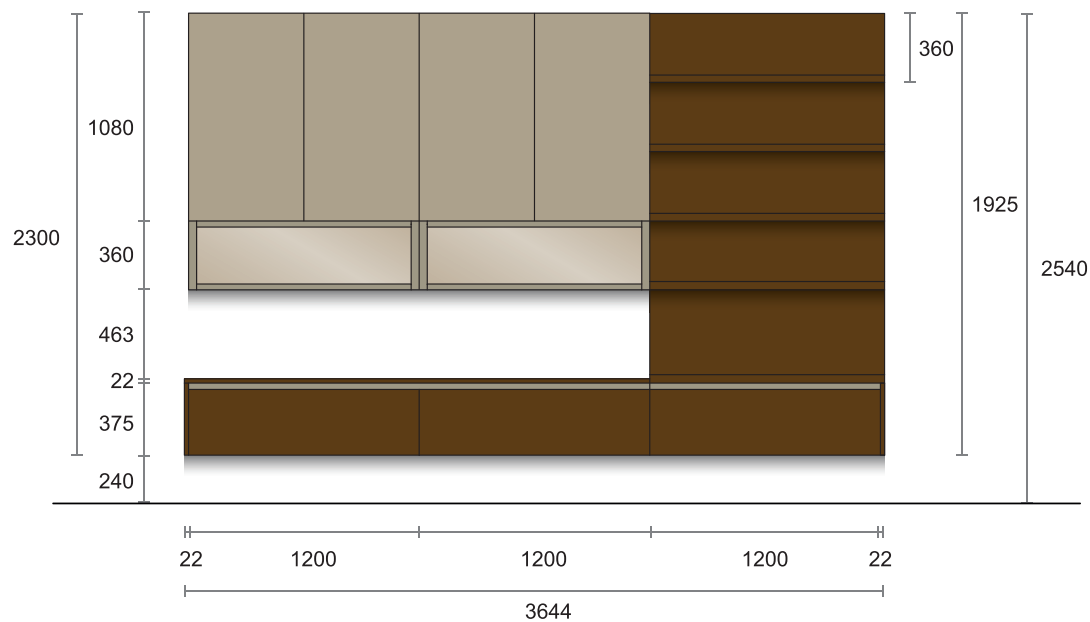

NR. ELEMENTI	DESCRIZIONE	CODICE
4	Pensile L 60 H 108 P 33,4 apertura push-pull	E2144601/2
2	Pensile vetro telaio alluminio L 120 H 36 P 33,4 apertura ribalta con maniglia	E1103200
2	Coprifianco H 108 P 31 laccato opaco	T98362
2	Coprifianco H 36 P 31 laccato opaco	T98340
3	Base living sospesa L 120 H 37,5 1 cestone	GBL76200
1	Schienale L 120 H 192,5 SP. 2,2 impiallacciato come anta	al mq 09452C
4	Mensola L 120 H 3,8 P 28,8 impiallacciata come anta	al ml 0917225
4	Maggiorazione per incasso luce	T9ILU
4	Luci led DIVA HE, L 1126	08617046
1	Alimentatore per luce DIVA	08617144
1	Mensola L 122,2 H 3,8 P 50,4 impiallacciata come anta	al ml 0917305
1	Top living L 242,2 P 50,4 SP. 2,2 impiallacciato come anta	al ml TLH225
2	Fianco living P.50,4 H 37,5 SP. 2,2 impiallacciato come anta	al ml TLH225F
3	Asta appendipensili ml 2	08610501

No. of ELEMENTS	DESCRIPTION	CODE
4	Wall unit W 60 H 108 D 33,4 push-pull opening	E2144601/2
2	Glass wall unit door with aluminium frame W 120 H 36 D 33,4 flap door with handle opening	E1103200
2	Matt lacquered side panel H 108 D 31 same colour as door	T98362
2	Matt lacquered side panel H 36 D 31 same colour as door	T98340
3	Hanging living base unit W 120 H 37,5 1 deep drawer	GBL76200
1	Veneered back panel W 120 H 192,5 Th. 2,2 same colour as door	per m ² 09452C
4	Veneered shelf W 120 H 3,8 D 28,8 same colour as door	per lm 0917225
4	Surcharge for built-in light	T9ILU
4	Led light DIVA HE, W 1126	08617046
1	DIVA light power pack	08617144
1	Veneered shelf W 122,2 H 3,8 D 50,4 same colour as door	per lm 0917305
1	Veneered living worktop W 242,2 D 50,4 TH. 2,2 same colour as door	per lm TLH225
2	Veneered living side D 50,4 H 37,5 Th. 2,2 same colour as door	per lm TLH225F
3	Wall unit fixing strip lm 2	08610501

LIVING LC 05



ANTE
doors

STRUTTURA
carcass

VETRO LUCIDO
glossy glass

BIANCO CALDO
warm white

BIANCO
white

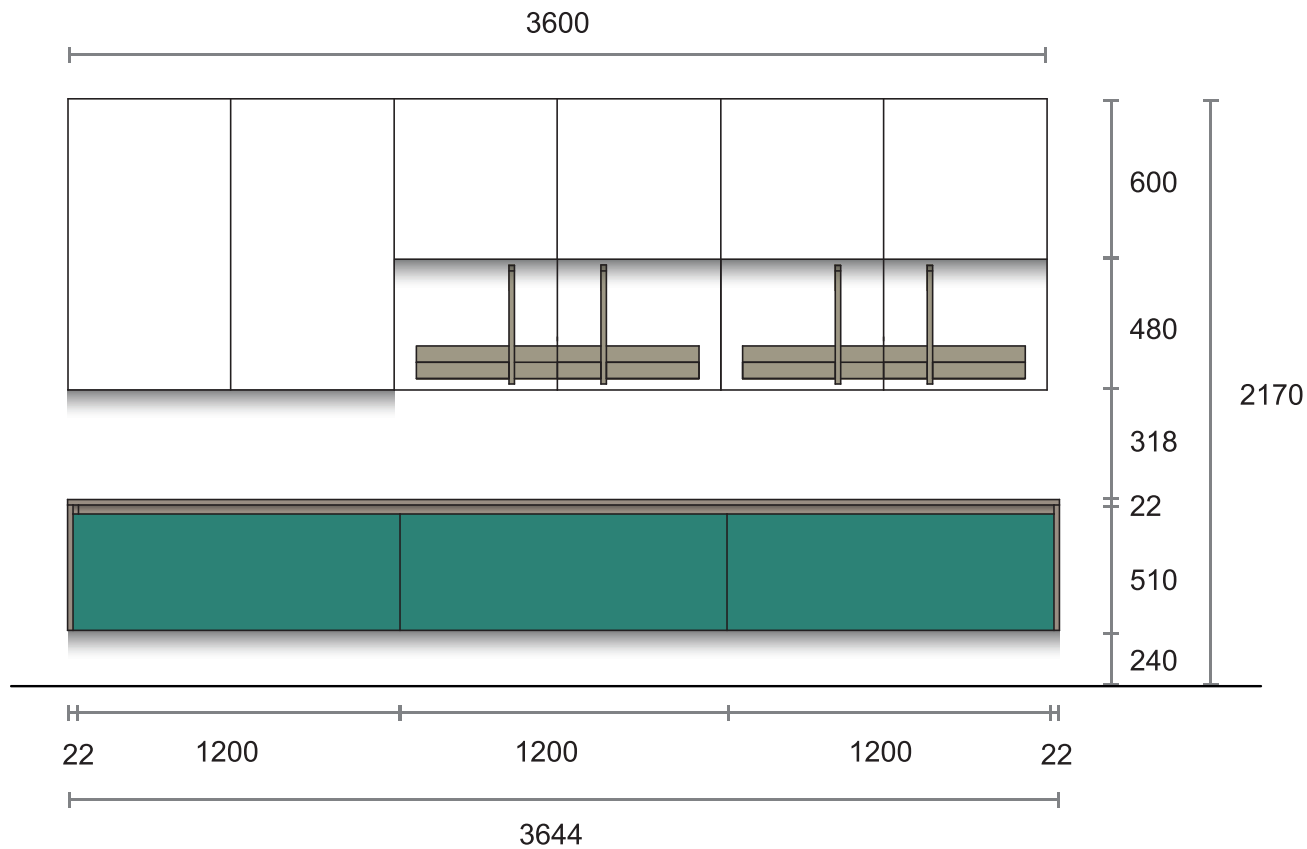

NR. ELEMENTI	DESCRIZIONE	CODICE
2	Pensile L 60 H 108 P 33,4 apertura con presa sul fondo	G2144601/2
4	Pensile L 60 H 60 P 33,4 apertura con presa sul fondo	G2060601/2
3	Base living sospesa L 120 H 51 P 50,4 1 cestone	GBL86200
1	Top living L 122,2 + L 242,2 P 50,4 SP. 2,2 laccato opaco	al ml TLC225
2	Fianco living P 50,4 H 51 SP. 2,2 laccato opaco	al ml TLC225F
4	Schienale "SHELF" L 60 H 48 SP. 2,2 laccato opaco con mensola in lamiera	E83048601/2
2	Coprifianco H 108 P 31 laccato come anta	T98362
1	Coprifianco H 60 P 31 laccato come anta	T98350
2	Asta appendipensili ml 2	08610501
No. of ELEMENTS	DESCRIPTION	CODE
2	Wall unit W 60 H 108 D 33,4 grip on bottom opening	G2144601/2
4	Wall unit W 60 H 60 D 33,4 grip on bottom opening	G2060601/2
3	Hanging living base unit W 120 H 51 D 50,4 1 deep drawer	GBL86200
1	Matt lacquered living worktop W 122,2 + W 242,2 D 50,4 TH. 2,2	per lm TLC225
2	Matt lacquered living side D 50,4 H 51 Th. 2,2	per lm TLC225F
4	Matt lacquered "SHELF" back panel W 60 H 48 Th. 2,2 with metal sheet shelf	E83048601/2
2	Lacquered side panel H 108 D 31 same colour as door	T98362
1	Lacquered side panel H 60 D 31 same colour as door	T98350
2	Wall unit fixing strip lm 2	08610501

LIVING LC 06



ANTE
doors

LACCATO OPACO
matt lacquered



FUMO
smoke

IMPIALLACCIATO
veneered

ELEMENTI A GIORNO
open units



ROVERE GRIGIO NEBBIA
mist grey oak

NOBILITATO
melamine-coated

STRUTTURA
carcass



BIANCO
white

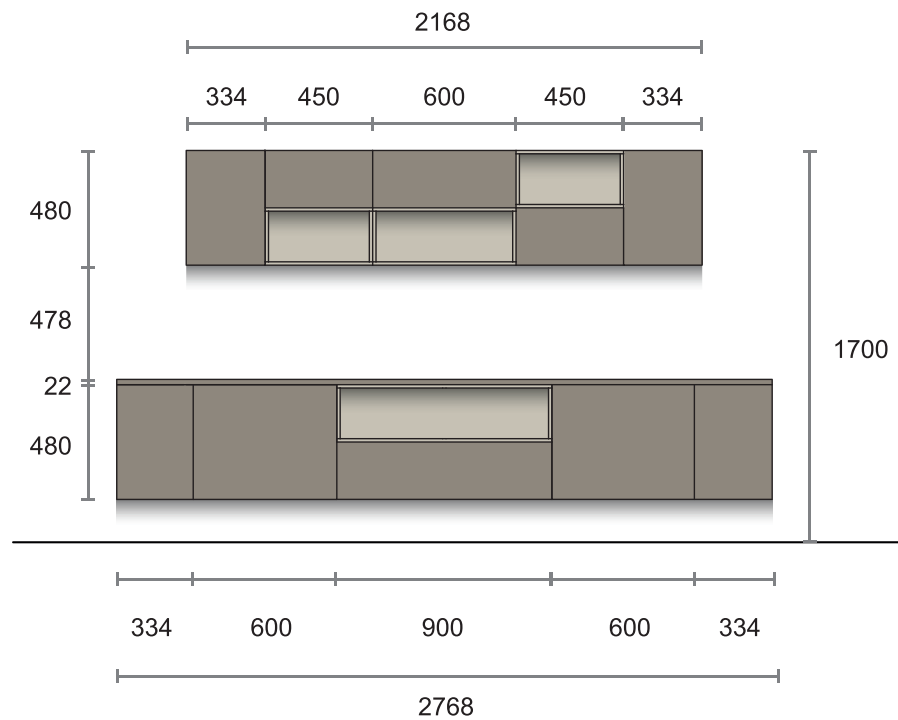

NR. ELEMENTI	DESCRIZIONE	CODICE
2	Terminale pensile curvo L 33,4 H 48 P 33,4 apertura push-pull	E2534311/2
2	Pensile L 45 H 24 P 33,4 apertura push-pull	EP002451/2
1	Pensile L 60 H 24 P 33,4 apertura push-pull	EP002601/2
2	Elemento a giorno L 45 H 24 P 31 impiallacciato	E7702701
1	Elemento a giorno L 60 H 24 P 31 impiallacciato	E7702702
2	Terminale base curvo sospeso L 33,4 H 48 P 31 apertura push-pull	EBTL1501/2
2	Base living sospesa L 60 H 48 P 50,4 1 cestone apertura tip-on	EBL85600
1	Base living sospesa L 90 H 24 P 50,4 1 cassetto apertura tip-on	EBL63900
1	Elemento a giorno 1 vano L 90 H 24 P 31, impiallacciato	E7706009
1	Top laccato L 276,8 P 50,4 SP. 2,2 colore come anta	al ml TLC225
2	Lavorazione stondatura top	T9STP
2	Asta appendipensili ml 2	08610501
No. of ELEMENTS	DESCRIPTION	CODE
2	Curved end wall unit W 33,4 H 48 D 33,4 push-pull opening	E2534311/2
2	Wall unit W 45 H 24 D 33,4 flap door push-pull opening	EP002451/2
1	Wall unit W 60 H 24 D 33,4 flap door push-pull opening	EP002601/2
2	Veneered open unit element W 45 H 24 D 31	E7702701
1	Veneered open unit element W 60 H 24 D 31	E7702702
2	Hanging curved end base unit W 33,4 H 48 D 31 push-pull opening	EBTL1501/2
2	Hanging living base unit W 60 H 48 D 50,4 1 deep drawer tip-on opening	EBL85600
1	Hanging living base unit W 90 H 24 D 50,4 1 drawer tip-on opening	EBL63900
1	Veneered open unit element with 1 compartment W 90 H 24 D 31	E7706009
1	Lacquered worktop W 276,8 D 50,4 Th. 2,2 same colour as door	per lm TLC225
2	Rounded worktop processing	T9STP
2	Wall unit fixing strip lm 2	08610501

LIVING LC 07



ANTE
doors

LACCATO OPACO
matt lacquered



CASTORO
beaver

ELEMENTI A GIORNO
open units

LACCATO OPACO
matt lacquered



CASTORO
beaver

NOBILITATO
melamine-coated

STRUTTURA
carcass



BIANCO
white

IMPIALLACCIATO
veneered

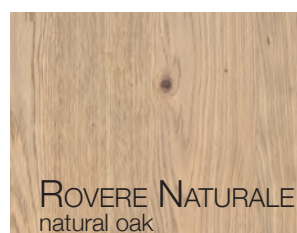

ROVERE NATURALE
natural oak

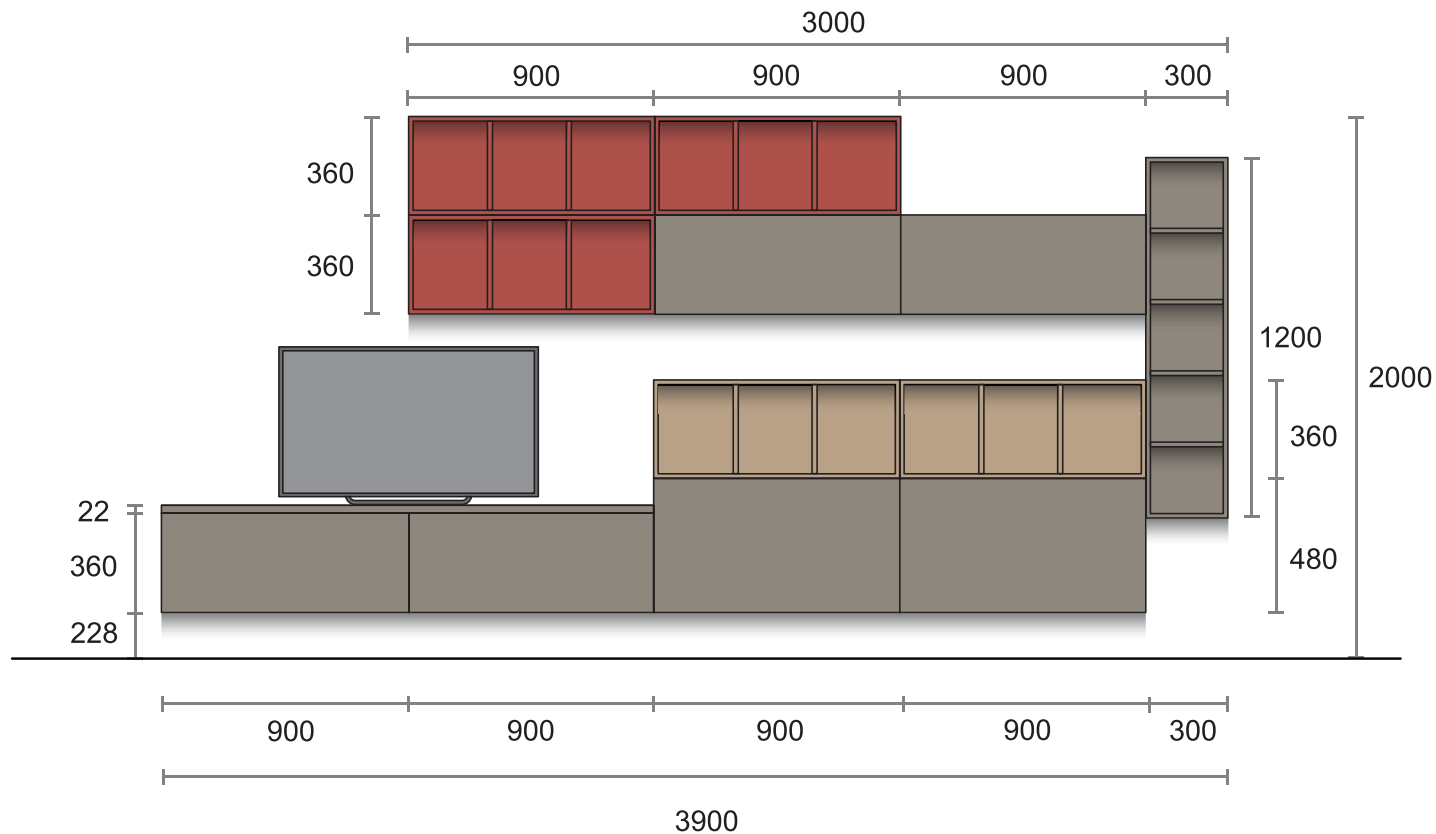

NR. ELEMENTI	DESCRIZIONE	CODICE
3	Elemento a giorno 3 vani L 90 H 36 P 31 laccato opaco	E7701712
2	Pensile L 90 H 36 P 33,4 ribalta apertura tip-on	E210090T
2	Pensile L 90 H 36 P 33,4 apertura vasistas	E2106900
2	Pensile L 90 H 48 P 33,4 apertura vasistas	E2123900
1	Coprifianco 36x31 laccato opaco	T98340
2	Coprifianco 48x31 laccato opaco	T98345
2	Elemento a giorno 3 vani L 90 H 36 P 31 impiallacciato	E7702712
1	Elemento a giorno 5 vani L 30 H 120 P 31 laccato opaco	E7701736
1	Top laccato L 180,1 P 33,4 SP. 2,2	al ml TLC225
3	Asta appendispensili ml 2	08610501
No. of ELEMENTS	DESCRIPTION	CODE
3	Matt lacquered open unit with 3 compartments W 90 H 36 D 31	E7701712
2	Wall unit W 90 H 36 D 33,4 flap door tip-on opening	E210090T
2	Wall unit W 90 H 36 D 33,4 flap door opening	E2106900
2	Wall unit W 90 H 48 D 33,4 flap door opening	E2123900
1	Matt lacquered side panel 36x31	T98340
2	Matt lacquered side panel 48x31	T98345
2	Veneered open unit with 3 compartments W 90 H 36 D 31	E7702712
1	Matt lacquered open unit with 5 compartments W 30 H 120 D 31	E7701736
1	Lacquered worktop W 180,1 D 33,4 Th. 2,2	per lm TLC225
3	Wall unit fixing strip lm 2	08610501

LIVING LC 08



ANTE
doors

ELEMENTI A GIORNO
open units

STRUTTURA
carcass

VETRO SATINATO
satin glass

LAMIERA
metal

NOBILITATO
melamine-coated

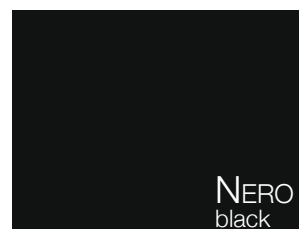

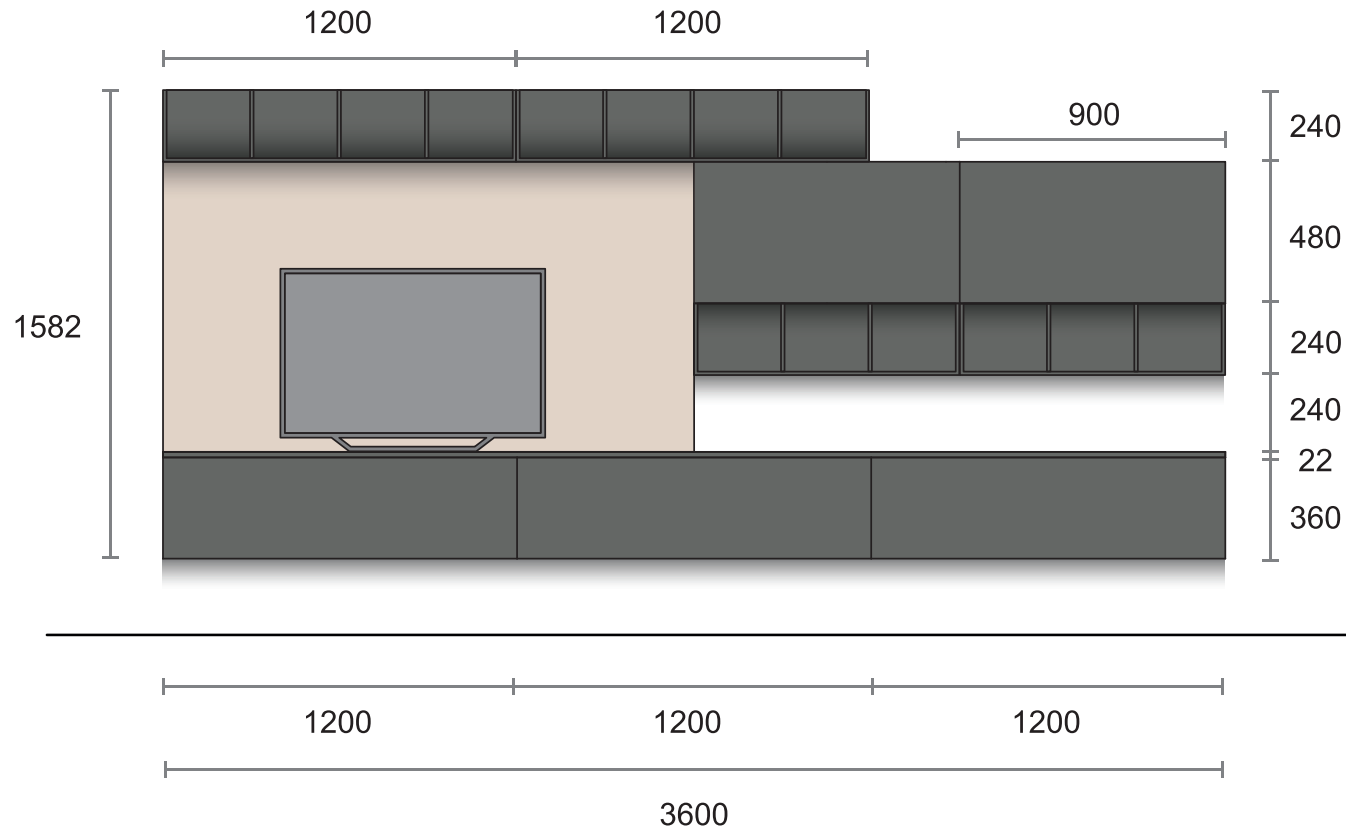

NR. ELEMENTI	DESCRIZIONE	CODICE
2	Pensile L 90 H 48 P 33,4 apertura verticale	EP204900
2	Pensile a giorno in lamiera aperto sopra con 4 vani L 120 H 24 P 31	E7710018
2	Pensile a giorno in lamiera aperto sopra con 3 vani L 90 H 24 P 31	E7710017
3	Pensile L 120 H 36 P 33,4 apertura vasistas con push-pull	E2107200
2	Coprifianco 48x31 laccato opaco	T98345
2	Coprifianco 36x31 laccato opaco	T98340
1	Top laccato L 240,1 + L 120,1 P 33,4 SP. 2,2	al ml TLC223
1	Schienale L 150 H 96 SP. 2,2 impiallacciato	al mq 09452SA
5	Asta appendipensili ml 2	08610501
No. of ELEMENTS	DESCRIPTION	CODE
2	Wall unit W 90 H 48 D 33,4 vertical opening	EP204900
2	Metal top open wall unit with 4 compartments W 120 H 24 D 31	E7710018
2	Metal top open wall unit with 3 compartments W 90 H 24 D 31	E7710017
3	Wall unit W 120 H 36 D 33,4 flap door with push-pull opening	E2107200
2	Matt lacquered side panel 48x31	T98345
2	Matt lacquered side panel 36x31	T98340
1	Lacquered worktop W 240,1 + W 120,1 D 33,4 Th. 2,2	per lm TLC223
1	Back panel W 150 H 96 Th. 2,2 veneered	per m ² 09452SA
5	Wall unit fixing strip lm 2	08610501

LIVING LC 09



ANTE
doors

ELEMENTI A GIORNO
open units

STRUTTURA
carcass

IMPIALLACCIATO
veneered

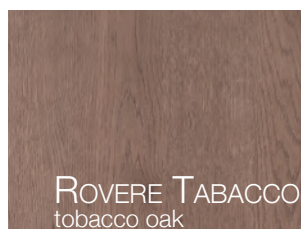

LACCATO OPACO
matt lacquered



NOBILITATO
melamine-coated



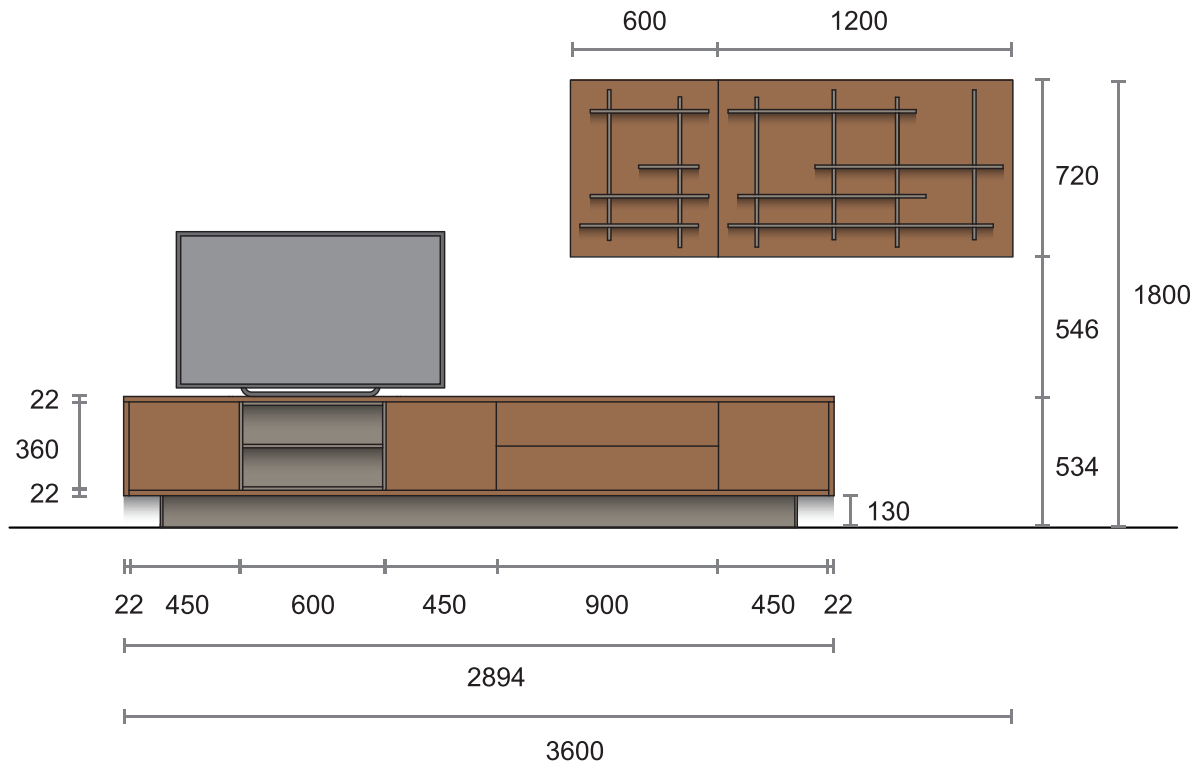

NR. ELEMENTI	DESCRIZIONE	CODICE
3	Base living "PLAN" in appoggio L 45 H 36 P 50,4 cestone, apertura tip-on	EBA35450
1	Base living "PLAN" in appoggio L 90 H 36 P 50,4 2 cassetti H 18, apertura tip-on	EBA33900
1	Elemento a giorno in appoggio L 60 H 36 2 vani, laccato opaco	E7702415
1	Top living "PLAN" superiore L 289,4 P 50,4 SP. 2,2 impiallacciato come anta	al ml TLHP225
1	Top living "PLAN" inferiore L 285 P 50,4 SP. 2,2 impiallacciato come anta	al ml TLHP225
2	Fianco living "PLAN" P 50,4 H 38,2 SP. 2,2 impiallacciato come anta	al ml TLHP225F
1	Basamento in ferro L 269,4 H 13 P 40,4 nella finitura titanio	al ml T92541
1	Schienale "WEAVE" L 60 H 72 SP. 2,2 impiallacciato come anta con mensole laccate opache	E83572060
1	Schienale "WEAVE" L 120 H 72 SP. 2,2 impiallacciato come anta con mensole laccate opache	E83572120
No. of ELEMENTS	DESCRIPTION	CODE
3	Lay on "PLAN" living base unit W 45 H 36 D 50,4 deep drawer tip-on opening	EBA35450
1	Lay on "PLAN" living base unit W 90 H 36 D 50,4 2 drawers H 18 tip-on opening	EBA33900
1	Lay on open element W 60 H 36 with 2 compartments, matt lacquered	E7702415
1	"PLAN" upper veneered living worktop W 289,4 D 50,4 TH. 2,2 same colour as door per lm	TLHP225
1	"PLAN" lower veneered living worktop W 285 D 50,4 TH. 2,2 same colour as door per lm	TLHP225
2	"PLAN" living side D 50,4 H 38,2 TH. 2,2 veneered same colour as door per lm	TLHP225F
1	Iron basement W 269,4 H 13 D 40,4 titanium finish	per lm T92541
1	Veneered "WEAVE" back panel W 60 H 72 TH. 2,2 same colour as door with shelves matt lacquered	E83572060
1	Veneered "WEAVE" back panel W 120 H 72 TH. 2,2 same colour as door with shelves matt lacquered	E83572120

LIVING A SPALLA LC 10



ANTE
doors

ELEMENTI A GIORNO
open units

STRUTTURA
carcass

IMPIALLACCIATO
veneered

LACCATO OPACO
matt lacquered

NOBILITATO
melamine-coated

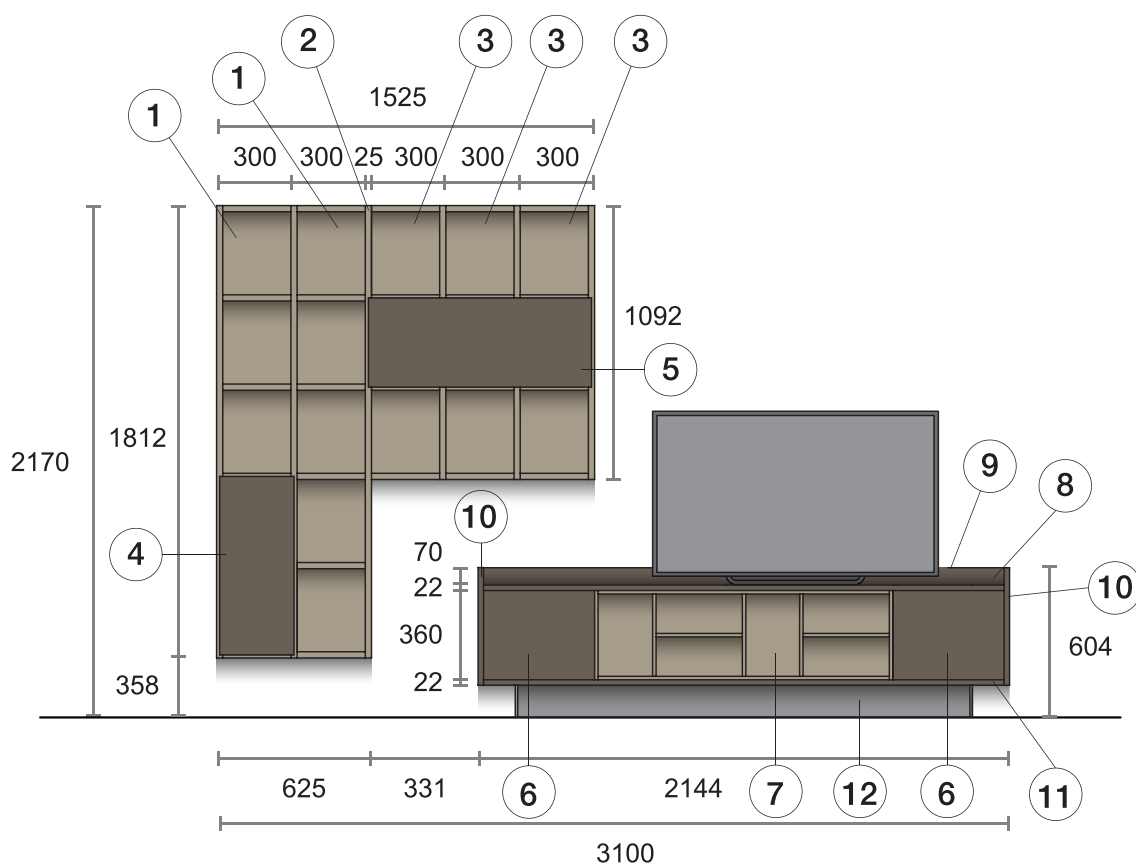
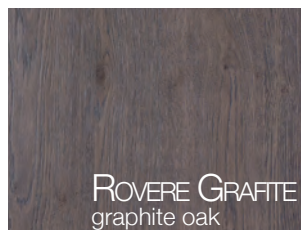

LACCATO OPACO
matt lacquered



SCHIENA
back panel

LACCATO OPACO
matt lacquered



LIVING A SPALLA LC 11



ANTE
doors

ELEMENTI A GIORNO
open units

STRUTTURA
carcass

IMPIALLACCIATO
veneered

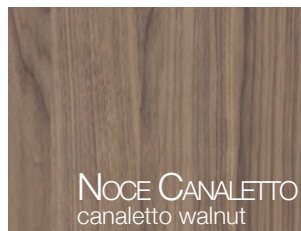

LACCATO OPACO
matt lacquered



NOBILITATO
melamine-coated

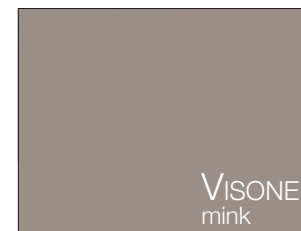

LACCATO OPACO
matt lacquered

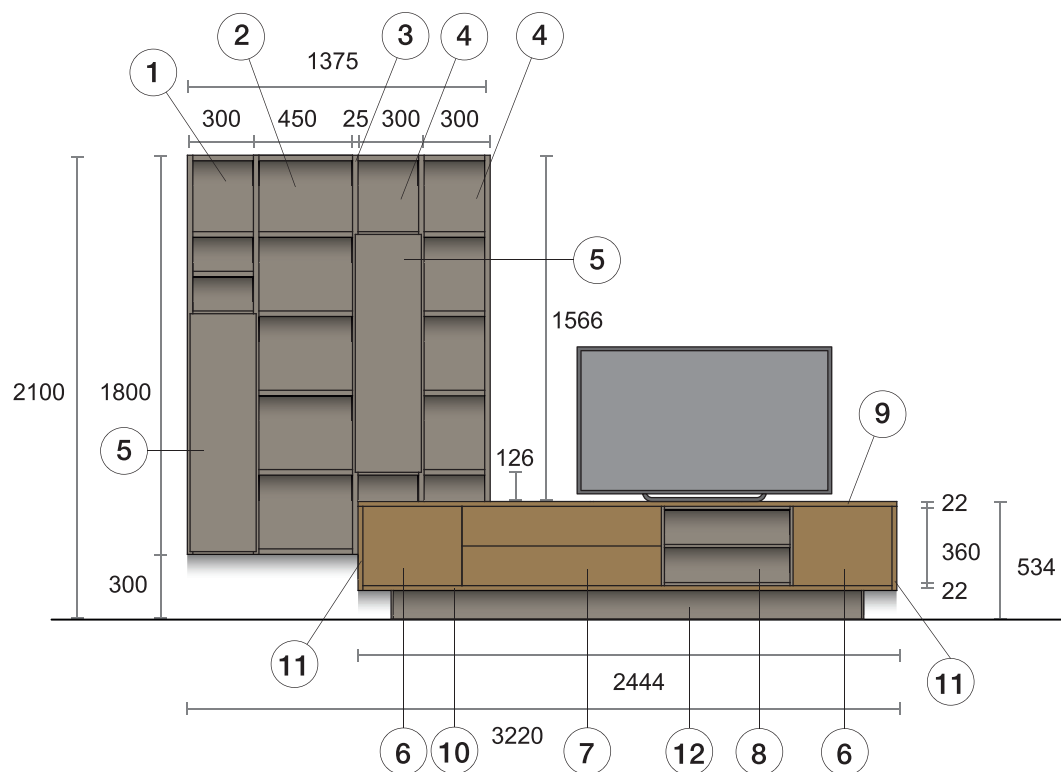

LIVING A SPALLA LC 12



ANTE
doors

SCHIENA
back panel

STRUTTURA
carcass

LACCATO OPACO
matt lacquered

LACCATO OPACO
matt lacquered

NOBILITATO
melamine-coated

LAVAGNA
slate grey

IMPIALLACCIATO
veneered

LACCATO OPACO
matt lacquered

FUMO
smoke

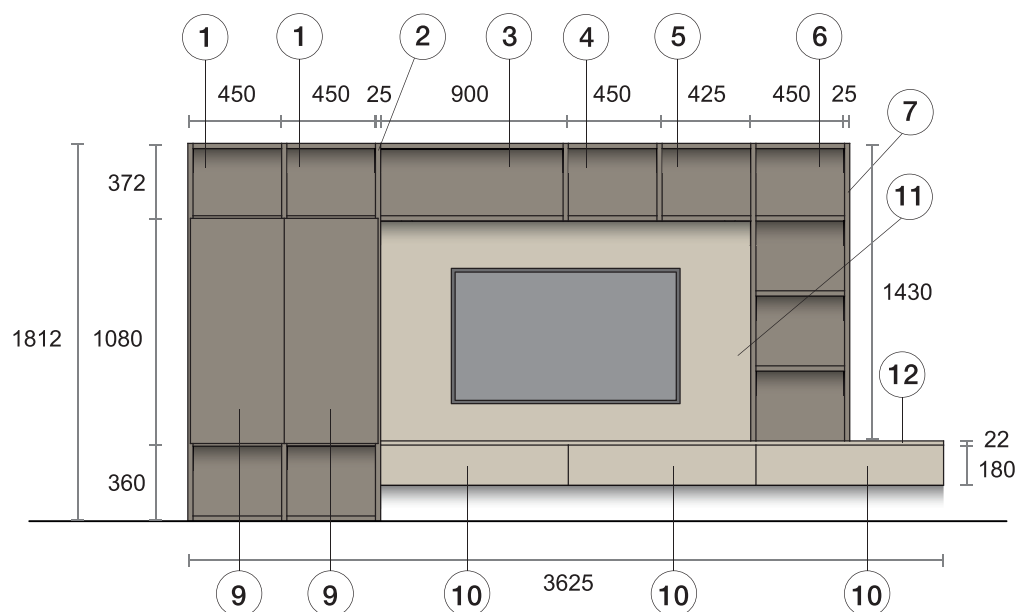
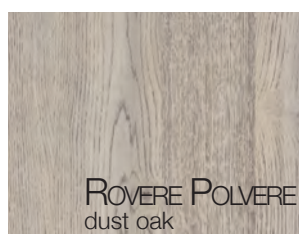

LIVING A SPALLA LC 13



ANTE
doors

SCHIENA
back panel

STRUTTURA
carcass

LACCATO OPACO
matt lacquered



LACCATO OPACO
matt lacquered



NOBILITATO
melamine-coated



IMPIALLACCIATO
veneered



LACCATO OPACO
matt lacquered



VETRO
glass

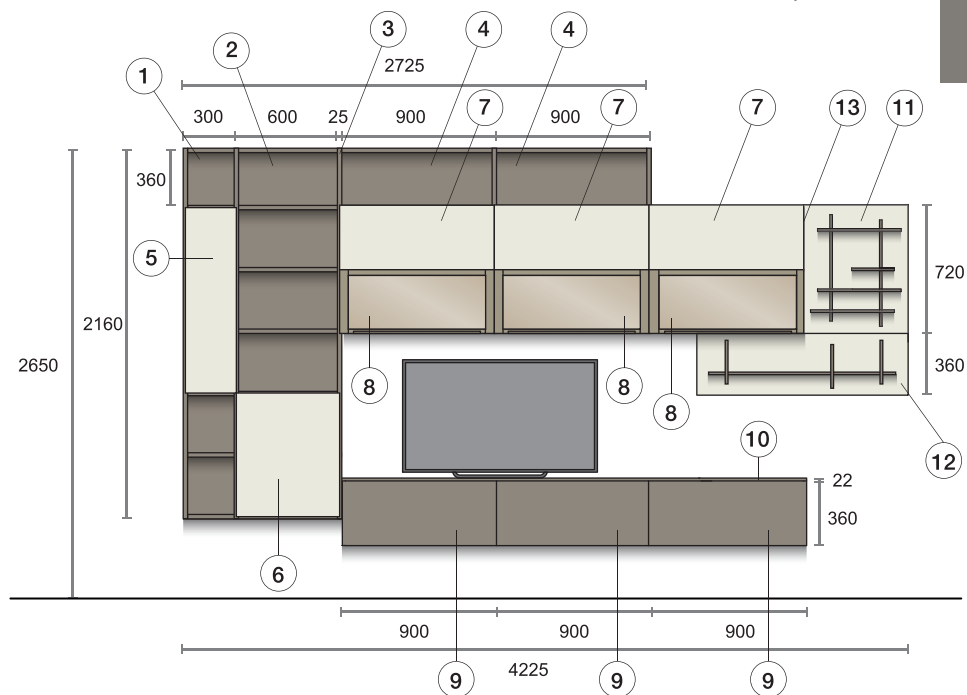
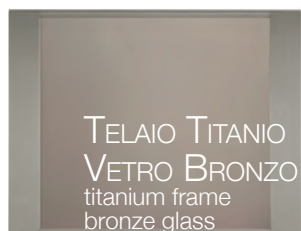

LIVING A SPALLA LC 14



ANTE
doors

SCHIENA
back panel

STRUTTURA
carcass

LACCATO OPACO
matt lacquered



LACCATO OPACO
matt lacquered



NOBILITATO
melamine-coated



LACCATO OPACO
matt lacquered

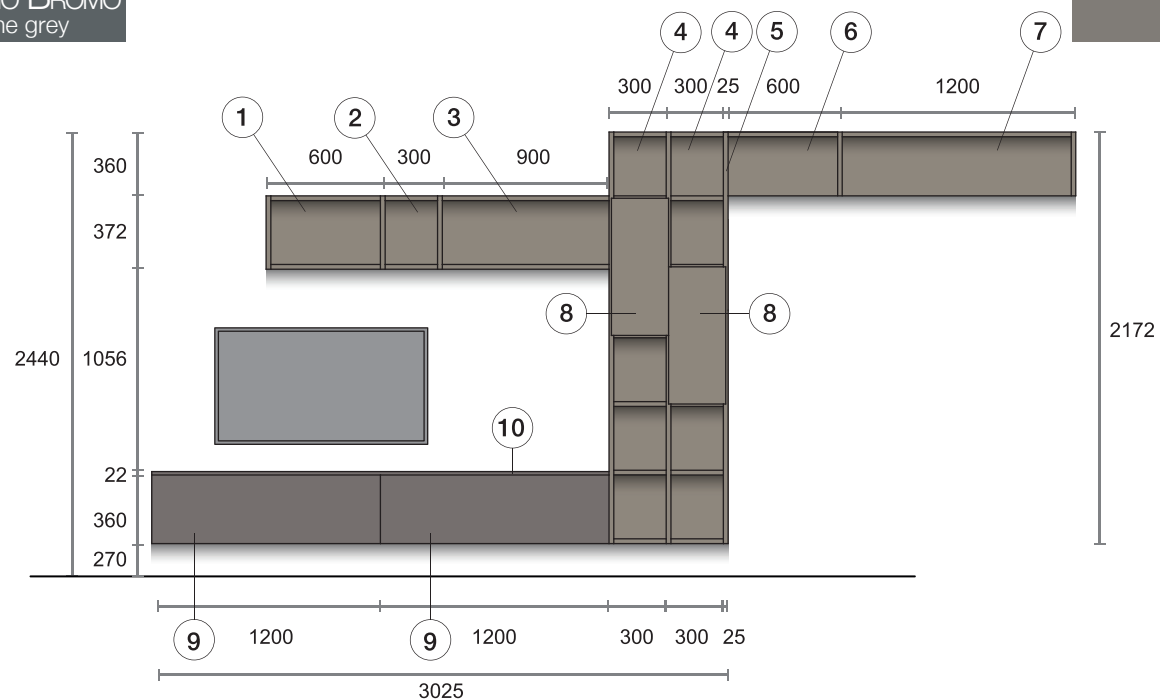

LIVING A SPALLA LC 15



ANTE
doors

LACCATO OPACO
matt lacquered



LACCATO OPACO
matt lacquered

ELEMENTI A GIORNO
open units



NOBILITATO
melamine-coated

STRUTTURA
carcass



SCHIENA
back panel

LACCATO OPACO
matt lacquered

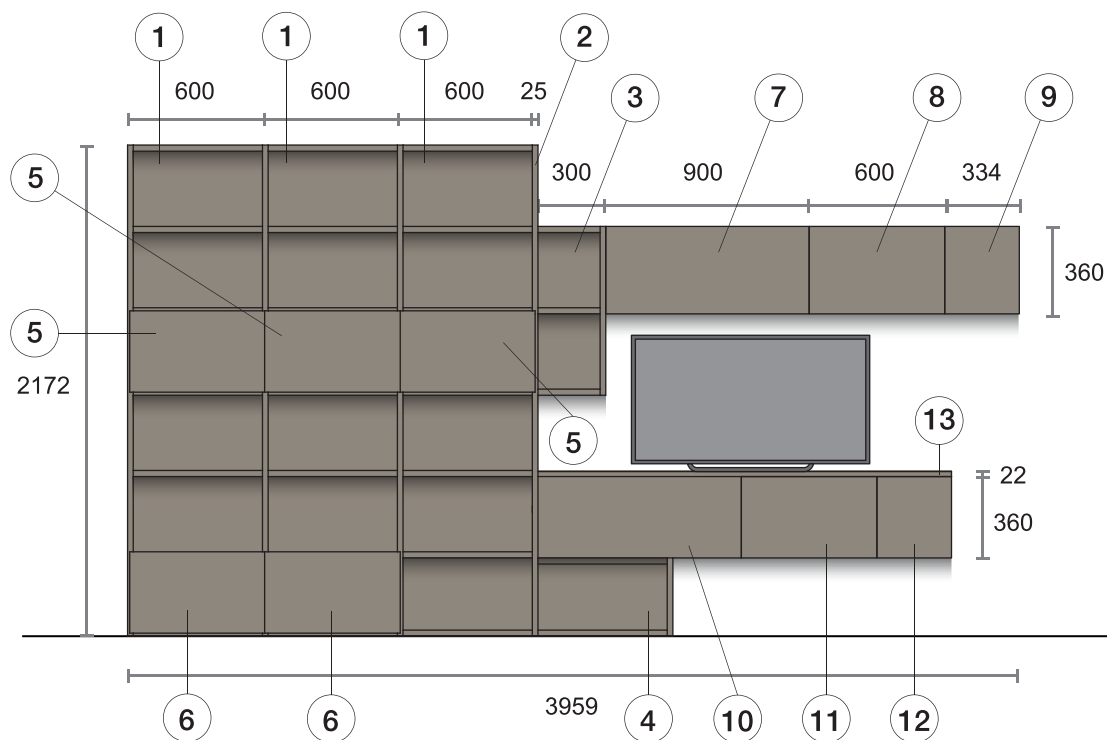

STRUTTURA A PARETE VERTICAL LINE

VERTICAL LINE WALL MOUNTED STRUCTURE

Libreria in metallo con installazione a parete disponibile nelle misure: L 60 - L 90 - L 120 (regolabile da 208 a 214) numero 5 ripiani

Metal wall-mounted bookcase, available in the following sizes:

W60 - W90 - W120 (adjustable from H 208 to H 214) with 5 shelves

L 60 - L 90 - L 120 (regolabile da 238 a 244) numero 6 ripiani

W60 - W90 - W120 (adjustable from H 238 to H 244) with 6 shelves

L 60 - L 90 - L 120 (regolabile da 268 a 274) numero 6 ripiani

W60 - W90 - W120 (adjustable from H 268 to H 274) with 6 shelves

VISTA FRONTALE
FRONT VIEW

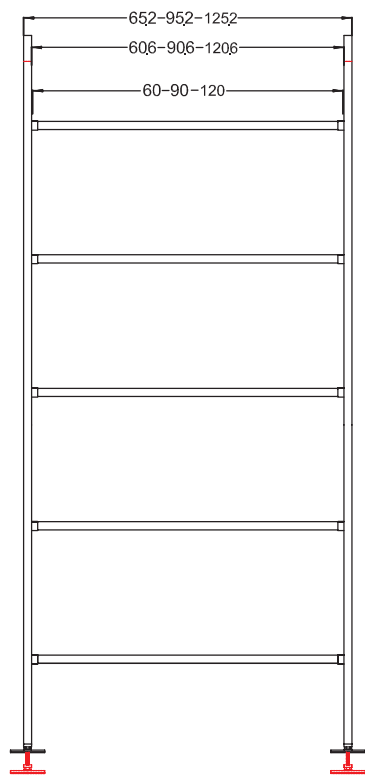

VISTA LATERALE
SIDE VIEW

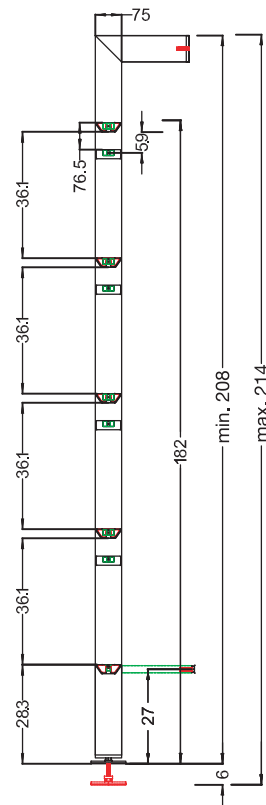

VISTA FRONTALE
FRONT VIEW

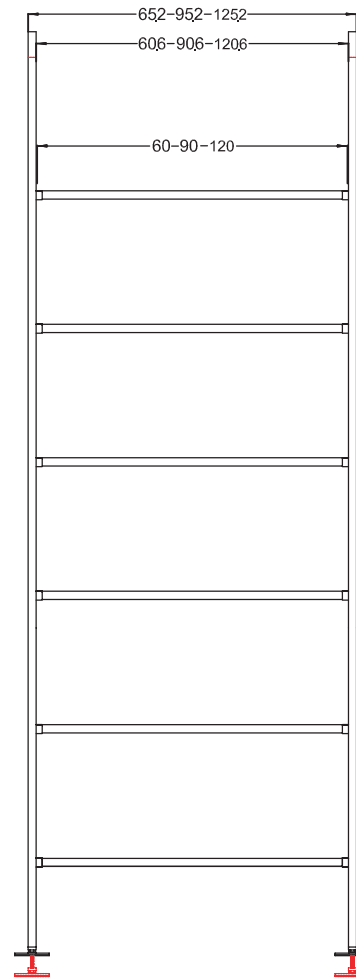

VISTA LATERALE
SIDE VIEW

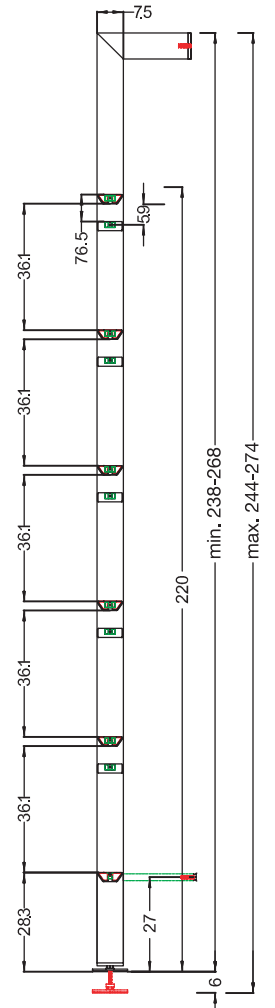

VISTA SUPERIORE
TOP VIEW



VISTA SUPERIORE
TOP VIEW



Finiture disponibili

Available finishes



nero (opz.AL11) titanio (opz.AL12)
black (opt.AL11) titanium (opt.AL12)

STRUTTURA A PARETE VERTICAL LINE MODULARE

VERTICAL LINE WALL MOUNTED STRUCTURE MODULARITY

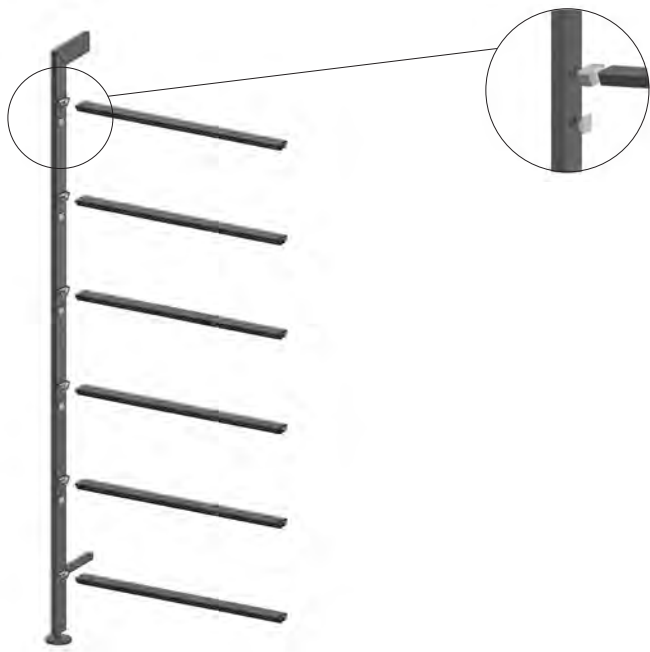

**Struttura base composta da:
montante sx e barre orizzontali**
nr.5 per H 208-214
nr.6 per H 238-244
nr.6 per H 268-274

Base structure consist of:
LH stile and horizontal pillars
nr.5 for H 208-214
nr.6 for H 238-244
nr.6 for H 268-274

H 208 - 214
L 60 0890600
L 90 0890610
L 120 0890620

H 238 - 244
L 60 0890630
L 90 0890640
L 120 0890650

H 268 - 274
L 60 0890660
L 90 0890670
L 120 0890680

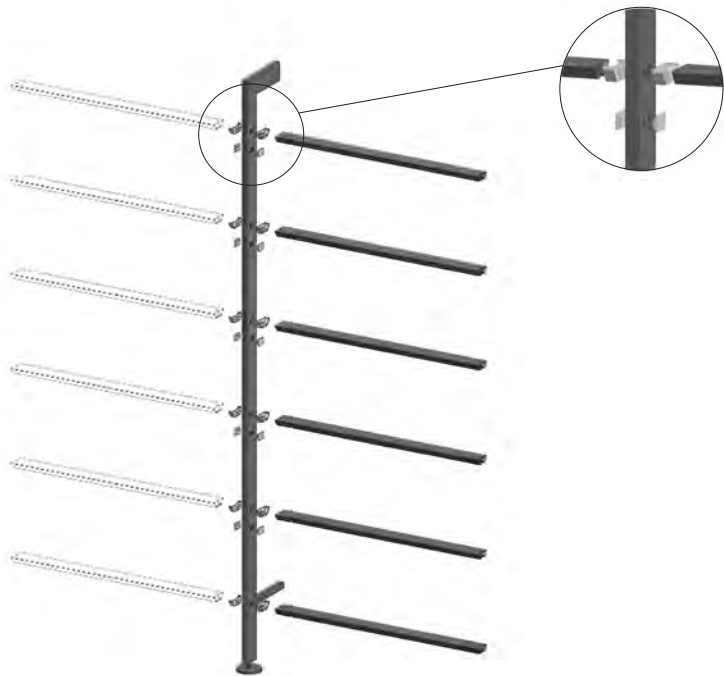

**Struttura centrale composta da:
montante centrale e barre orizzontali**
nr.5 per H 208-214
nr.6 per H 238-244
nr.6 per H 268-274

Central structure consist of:
central stile and horizontal pillars
nr.5 for H 208-214
nr.6 for H 238-244
nr.6 for H 268-274

H 208 - 214
L 60 0890600C
L 90 0890610C
L 120 0890620C

H 238 - 244
L 60 0890630C
L 90 0890640C
L 120 0890650C

H 268 - 274
L 60 0890660C
L 90 0890670C
L 120 0890680C

Montante di chiusura DX

LH closing stile



H 208 - 214
0890690D

H 238 - 244
0890691D

H 268 - 274
0890692D

STRUTTURA AD ISOLA VERTICAL LINE

VERTICAL LINE ISLAND MOUNTED STRUCTURE

Libreria in metallo con installazione a soffitto disponibile nelle misure:

L 60 - L 90 - L 120 (regolabile da 238 a 250) numero 6 ripiani **N.B.: possibilità di installare a parete mediante un distanziale in dotazione**

L 60 - L 90 - L 120 (regolabile da 268 a 280) numero 6 ripiani **N.B.: possibilità di installare a parete mediante un distanziale in dotazione**

L 60 - L 90 - L 120 (regolabile da 288 a 300) numero 7 ripiani **N.B.: installare solo a parete mediante un distanziale in dotazione**

Metal ceiling-mounted bookcase, available in the following sizes:

W60 - W90 - W120 (adjustable from H 238 to H 250) with 6 shelves **Note: it's possible to install it against the wall with the separator included**

W60 - W90 - W120 (adjustable from H 268 to H 280) with 6 shelves **Note: it's possible to install it against the wall with the separator included**

W60 - W90 - W120 (adjustable from H 288 to H 300) with 7 shelves **Note: install it only against the wall with the separator included**

VISTA FRONTALE
FRONT VIEW

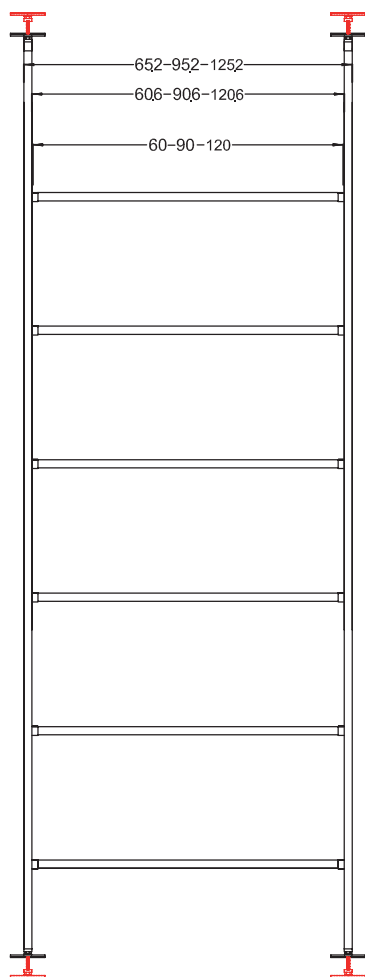

VISTA LATERALE
SIDE VIEW

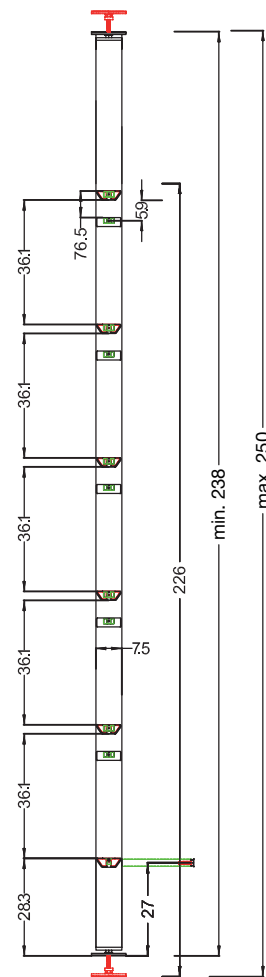

VISTA FRONTALE
FRONT VIEW

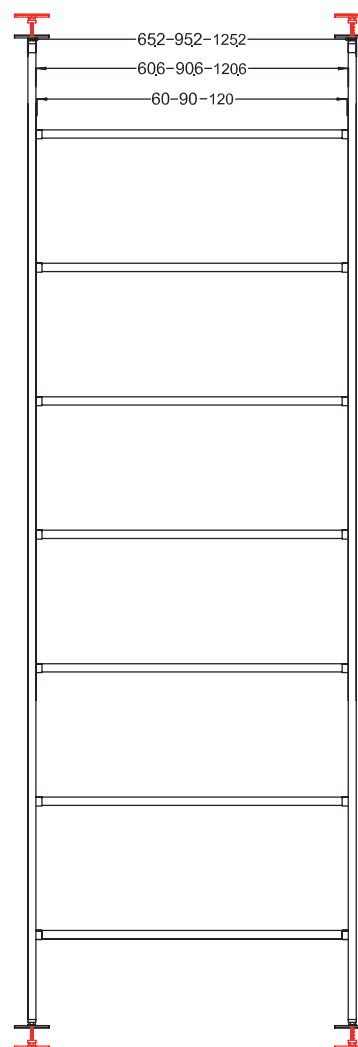

VISTA LATERALE
SIDE VIEW

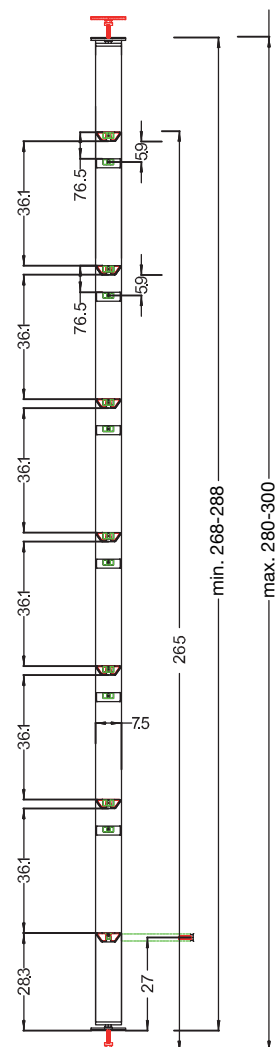

VISTA SUPERIORE
TOP VIEW



VISTA SUPERIORE
TOP VIEW



Finiture disponibili

Available finishes



nero (opz.AL11)
black (opt.AL11)



titanio (opz.AL12)
titanium (opt.AL12)

STRUTTURA AD ISOLA VERTICAL LINE MODULARE

VERTICAL LINE ISLAND MOUNTED STRUCTURE MODULARITY

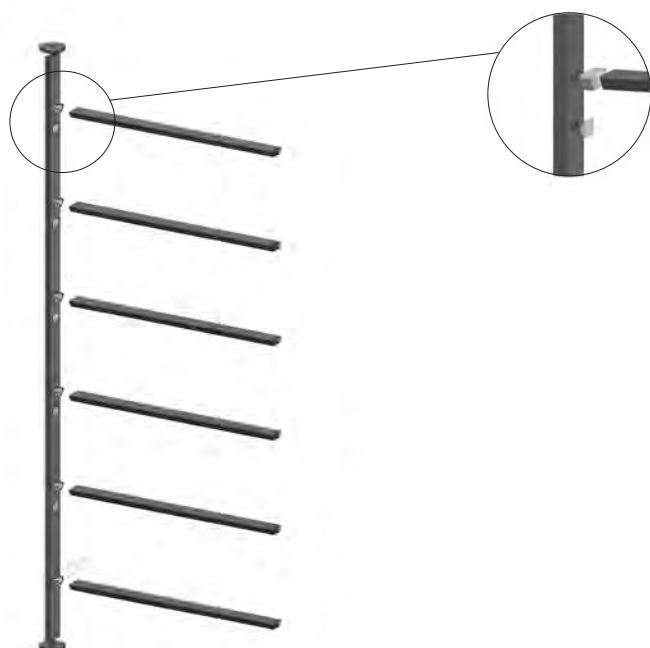

Struttura base composta da:
montante sx e barre orizzontali
nr.6 per H 238-250
nr.6 per H 268-280
nr.7 per H 288-300

Base structure consist of:
LH stile and horizontal pillars
nr.6 for H 238-250
nr.6 for H 268-280
nr.7 for H 288-300

H 238 - 250
L 60 0890500
L 90 0890510
L 120 0890520

H 268 - 280
L 60 0890530
L 90 0890540
L 120 0890550

H 288 - 300
L 60 0890560
L 90 0890570
L 120 0890580

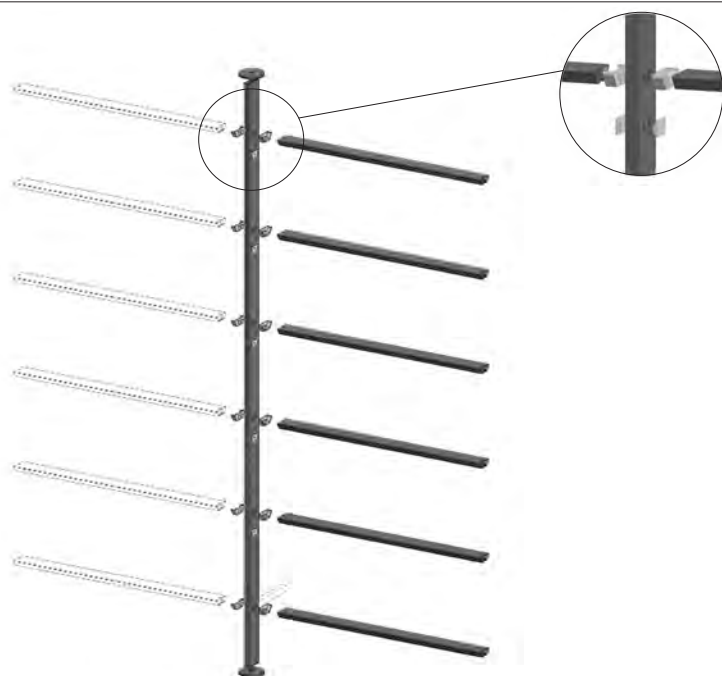

Struttura centrale composta da:
montante centrale e barre orizzontali
nr.6 per H 238-250
nr.6 per H 268-280
nr.7 per H 288-300

Central structure consist of:
central stile and horizontal pillars
nr.6 for H 238-250
nr.6 for H 268-280
nr.7 for H 288-300

H 238 - 250
L 60 0890500C
L 90 0890510C
L 120 0890520C

H 268 - 280
L 60 0890530C
L 90 0890540C
L 120 0890550C

H 288 - 300
L 60 0890560C
L 90 0890570C
L 120 0890580C

Montante di chiusura

LH closing stile





H 238 - 250
0890690

H 268 - 280
0890691

H 288 - 300
0890692

MENSOLE PER STRUTTURA VERTICAL LINE

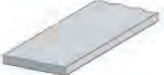
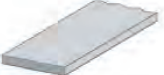
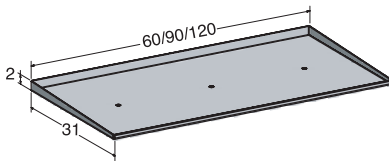
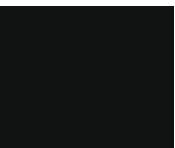
SHELVES FOR VERTICAL LINE STRUCTURE

		COD.						
 <p>mensola sp. 2,2 laccata opaca L 60 - L 90 - L 120 N.B.: per i colori vedi pag.461 Th. 2,2 matt lacquered shelf W 60 - W 90 - W 120 Note: for colours see page 461</p>	al ml P 31 per lm	091742						
 <p>mensola sp. 2,2 impiallacciata finitura come anta L 60 - L 90 - L 120 N.B.: per i colori vedi pag.461 veneered shelf Th. 2,2 same finish as door W 60 - W 90 - W 120 Note: for colours see page 461</p>	al ml P 31 per lm	0917200						
<p>vassoio in alluminio P 31 aluminium container D 31</p>  <p>Finiture disponibili Available finishes</p>   <p>nero (opz.AL11) titanio (opz.AL12) black (opt.AL11) titanium (opt.AL12)</p>		COD.						
	L 60	0890720						
	L 90	0890721						
	L 120	0890722						

STRUTTURA A PARETE VERTICAL LINE ESEMPIO DI COMPOSIZIONE

VERTICAL LINE WALL MOUNTED STRUCTURE EXAMPLE OF COMPOSITION

ESEMPIO COMPOSIZIONE L 95,2+95,2 H 238-244
 EXAMPLE OF COMPOSITION W95,2+95,2 H 238-244

DESCRIZIONE / DESCRIPTION	CODICE / CODE No.			
N°2 struttura base L 90 H 238-244 No.2 base structures W 90 H 238-244	0890640			
N°2 montante di chiusura dx H 238-244 No.2 RH closing stile H 238-244	0890691D			
N°9 mensole L 90 P 31 No.9 shelves W 90 D 31	laccato opaco matt lacquered 091742			
	impiallacciato veneered 0917200			
N°1 pensile a ribalta tip-on L 90 H 36 P 33,4 No.1 wall unit flap door, tip-on opening W 90 H 36 D 33,4	laccato opaco matt lacquered EPF2290L			
	impiallacciato veneered EPF2290I			
N°2 pensili winch L 90 H 36 P 33,4 No.2 wall units flap door, W 90 H 36 D 33,4	laccato opaco matt lacquered EPF5290L			
	impiallacciato veneered EPF5290I			
TOTALE TOTAL				

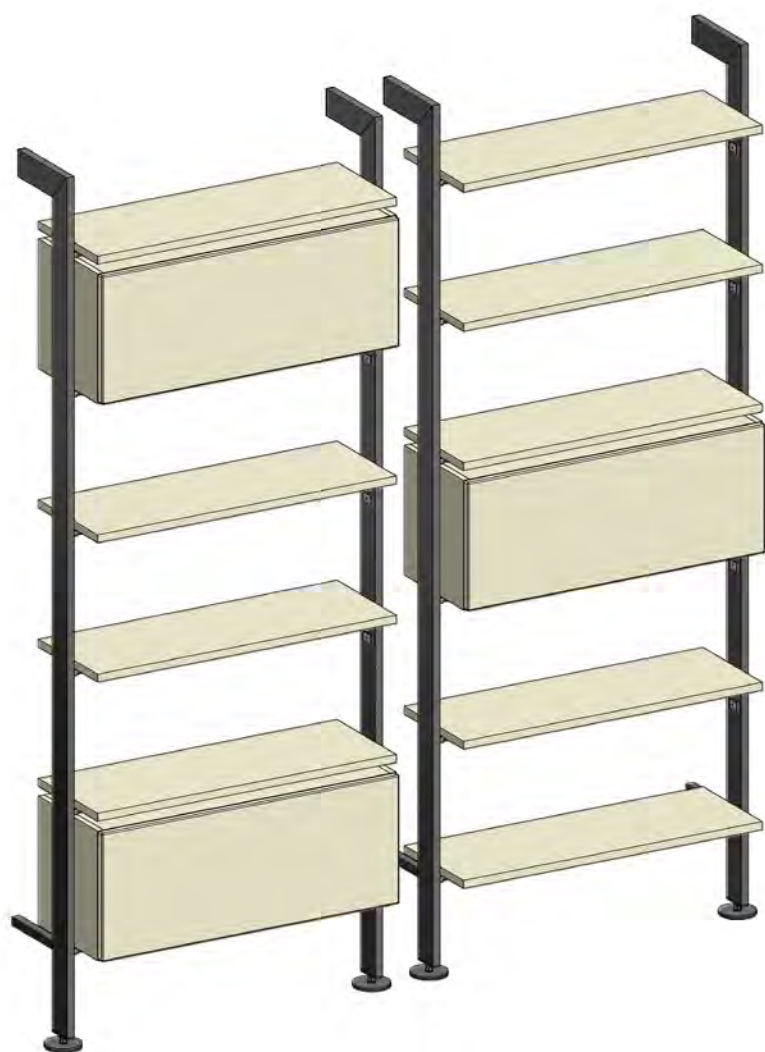

Vista frontale
Front view

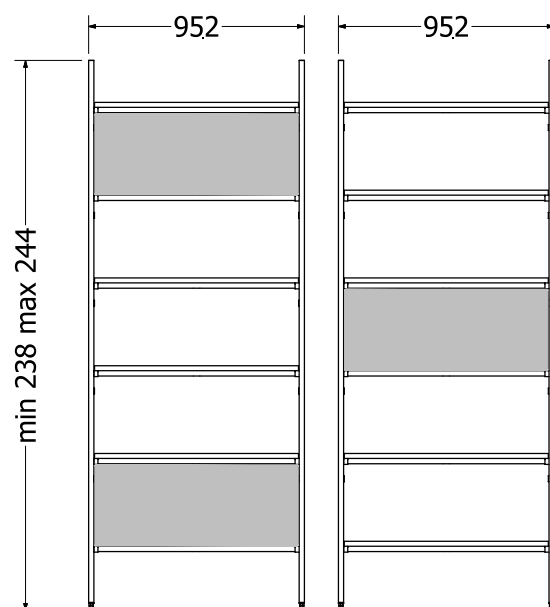

Vista laterale
Side view

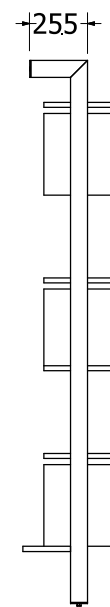

Vista superiore
Top view

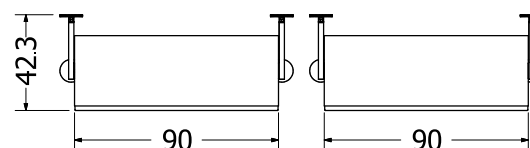

STRUTTURA A PARETE VERTICAL LINE ESEMPIO DI COMPOSIZIONE

VERTICAL LINE WALL MOUNTED STRUCTURE EXAMPLE OF COMPOSITION

ESEMPIO COMPOSIZIONE L 188,1 H 238-244
 EXAMPLE OF COMPOSITION W 188,1 H 238-244

DESCRIZIONE / DESCRIPTION	CODICE / CODE No.			
N°1 struttura base L 90 H 238-244 No.1 base structure W 90 H 238-244	0890640			
N°1 struttura centrale L 90 H 238-244 No.1 central structure W 90 H 238-244	0890640C			
N°1 montante di chiusura dx H 238-244 No.1 RH closing stile H 238-244	0890691D			
N°8 mensole L 90 P 31 No.8 shelves W 90 D 31	laccato opaco matt lacquered	091742		
	impiallacciato veneered	0917200		
N°4 mensole alluminio L 90 P 31 N°4 aluminium shelves W 90 D 31	0890721			
	TOTALE TOTAL			



Vista frontale
Front view

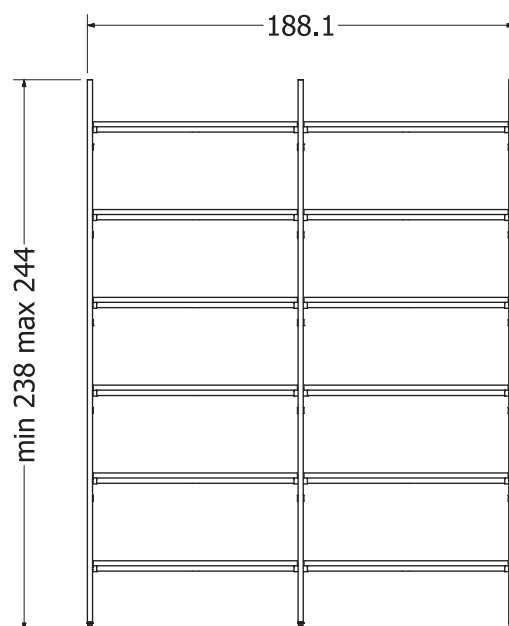

Vista laterale
Side view

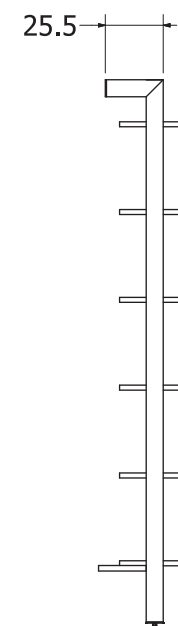

Vista superiore
Top view

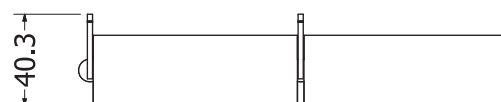

STRUTTURA AD ISOLA VERTICAL LINE ESEMPIO DI COMPOSIZIONE

VERTICAL LINE ISLAND STRUCTURE EXAMPLE OF COMPOSITION

ESEMPIO COMPOSIZIONE L 188,1 H 238-250
 EXAMPLE OF COMPOSITION W 188,1 H 238-250

DESCRIZIONE / DESCRIPTION	CODICE / CODE No.			
N°1 struttura base L 90 H 238-250 No.1 base structure W 90 H 238-250	0890510			
N°1 struttura centrale L 90 H 238-250 No.1 central structure W 90 H 238-250	0890510C			
N°1 montante di chiusura H 238-250 No.1 closing stile H 238-250	0890690			
N°8 mensole L 90 P 31 No.8 shelves W 90 D 31	laccato opaco matt lacquered	091742		
	impiallacciato veneered	0917200		
N°4 mensole alluminio L 90 P 31 N°4 aluminium shelves W 90 D 31	0890721			
	TOTALE TOTAL			



Vista frontale
Front view

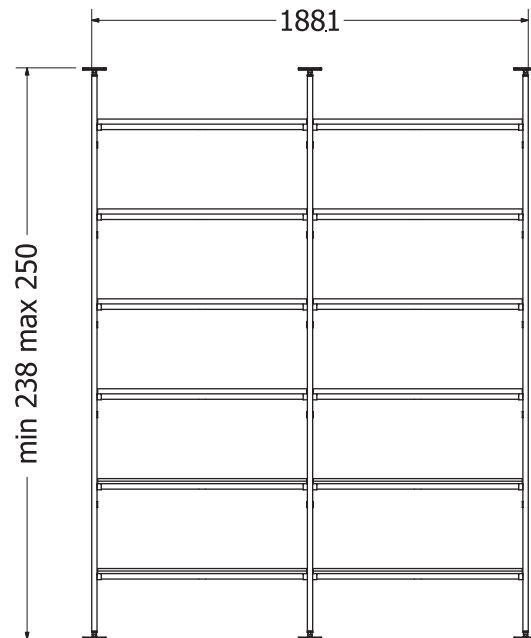

Vista laterale
Side view

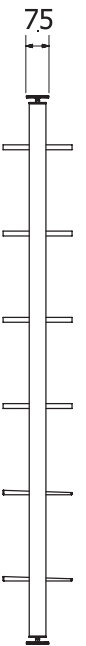

Vista superiore
Top view

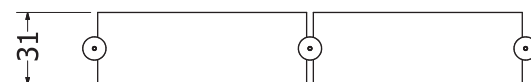

FINITURE MENSOLE ED ELEMENTI VERTICAL LINE

SHELVES AND ELEMENTS FINISHES FOR VERTICAL LINE

COLORI IMPIALLACCIATI VENEERED COLOURS

rovere grigio nebbia (opz.5401), fiamma verticale
mist grey oak (opt.5401),
vertical grain

rovere polvere (opz.5402),
fiamma verticale
dust oak (opt.5402),
vertical grain

rovere grafite (opz.5403),
fiamma verticale
graphite oak (opt.5403),
vertical grain

rovere naturale (opz.5404),
fiamma verticale
natural oak (opt.5404),
vertical grain

rovere tabacco (opz.5405),
fiamma verticale
tobacco oak (opt.5405),
vertical grain

rovere bianco (opz.5415),
fiamma orizzontale
white oak (opt.5415),
horizontal grain

rovere sahara (opz.5416),
fiamma orizzontale
sahara oak (opt.5416),
horizontal grain

rovere visone (opz.5417),
fiamma orizzontale
mink oak (opt.5417),
horizontal grain

rovere grigio cenere (opz.5418),
fiamma orizzontale
ash grey oak (opt.5418),
horizontal grain

rovere lavagna (opz.5419),
fiamma orizzontale
slate grey oak (opt.5419),
horizontal grain

rovere nero (opz.5420),
fiamma orizzontale
black oak (opt.5420),
horizontal grain

noce canaletto (opz.1324),
fiamma verticale
canaletto walnut (opt.1324),
vertical grain

rovere termocotto (opz.5410),
fiamma verticale
thermo-treated oak
(opt.5410), vertical grain



COMPOSIZIONE L 305

COMPOSITION W 305



COMPOSIZIONE L 300

COMPOSITION W 300



COMPOSIZIONE L 305

COMPOSITION W 305

COMPONENTI COMPONENTS

**Colonna 60 H 217 frigo-freezer 315 classe A+
con gola verticale e fianco come anta**

60 cm column H 217 fridge-freezer 315 class "A+"
with vertical finger rail and side panel same as door

Base 60 2 cassetti e cestone

60 cm base unit with 2 drawers and deep drawers

Base 60 forno multifunzione inox

60 cm base unit for stainless steel multifunctional oven

Piano cottura 60 4 gas inox con valvola

60 cm stainless steel hob with 4 burners with safety valve

Base 60

60 cm base unit

Sottolavello 60

60 cm sink unit

Lavello ad incasso 86 x 50 1 vasca inox

86x50 cm built-in sink with 1 stainless steel bowl

Top 240 P 61 in laminato H 4 bordo ABS1

240 cm laminate worktop D 61 H 4 with ABS1 edge

Pensile 60 H 72

60 cm wall unit H 72

Cappa 60 "Mod.29"

60 cm "Mod.29" hood

Pensile 60 H 72

60 cm wall unit H 72

Scolapiatti 60 H 72

60 cm plate rack H 72

Asta appendipensili ml 4

4 lm wall unit fixing strip

(Elettrodomestici Hotpoint)
(Hotpoint appliances)

COMPOSIZIONE L 300

COMPOSITION W 300

COMPONENTI COMPONENTS

Colonna 60 H 217 frigo-freezer 315 classe A+

60 cm column H 217 fridge-freezer 315 class "A+"

Base 60 2 cassetti e cestone

60 cm base unit with 2 drawers and deep drawers

Base 60 forno multifunzione inox

60 cm base unit for stainless steel multifunctional oven

Piano cottura 60 4 gas inox con valvola

60 cm stainless steel hob with 4 burners with safety valve

Base 60

60 cm base unit

Sottolavello 60

60 cm sink unit

Lavello ad incasso 86 x 50 1 vasca inox

86x50 cm built-in sink with 1 stainless steel bowl

Top 240 P 61 in laminato H 4 bordo ABS1

240 cm laminate worktop D 61 H 4 with ABS1 edge

Pensile 60 H 72

60 cm wall unit H 72

Cappa 60 "Mod.29"

60 cm "Mod.29" hood

Pensile 60 H 72

60 cm wall unit H 72

Scolapiatti 60 H 72

60 cm plate rack H 72

Asta appendipensili ml 4

4 lm wall unit fixing strip

(Elettrodomestici Hotpoint)
(Hotpoint appliances)

COMPOSIZIONE L 423

COMPOSITION W 423



COMPOSIZIONE L 420

COMPOSITION W 420



COMPOSIZIONE L 423

COMPOSITION W 423

COMPONENTI

COMPONENTS

Colonna 60 H 217 frigo-freezer 315 classe A+

60 cm column H 217 fridge-freezer 315 class "A+"

Colonna 60 H 217 forno multifunzione inox

60 cm column H 217 for stainless steel multifunctional oven

Base 60

60 cm base unit

Piano cottura 75 5 gas inox con valvola

75 cm stainless steel hob with 5 burners with safety valve

Base 90 2 cassetti e cestone predisposta piano cottura

90 cm base unit with 2 drawers and deep drawers configured for hob

Base 60

60 cm base unit

Sottolavello 90

90 cm sink unit

Lavello ad incasso 86 x 50 1 vasca inox

86x50 cm built-in sink with 1 stainless steel bowl

Top 300 P 61 in laminato H 4 bordo ABS1

300 cm laminate worktop D 61 H 4 with ABS1 edge

Pensile 60 H 72

60 cm wall unit H 72

Cappa 90 "STILO" inox

90 cm "STILO" stainless steel hood

Pensile 60 H 72

60 cm wall unit H 72

Scolapiatti 90 H 72

90 cm plate rack H 72

Asta appendispensili ml 4

4 lm wall unit fixing strip

(Elettrodomestici Hotpoint)

(Hotpoint appliances)

COMPOSIZIONE L 420

COMPOSITION W 420

COMPONENTI

COMPONENTS

Colonna 60 H 217 frigo-freezer 315 classe A+

60 cm column H 217 fridge-freezer 315 class "A+"

Colonna 60 H 217 forno multifunzione inox

60 cm column H 217 for stainless steel multifunctional oven

Base 60

60 cm base unit

Piano cottura 75 5 gas inox con valvola

75 cm stainless steel hob with 5 burners with safety valve

Base 90 2 cassetti e cestone predisposta piano cottura

90 cm base unit with 2 drawers and deep drawers configured for hob

Base 60

60 cm base unit

Sottolavello 90

90 cm sink unit

Lavello ad incasso 86 x 50 1 vasca inox

86x50 cm built-in sink with 1 stainless steel bowl

Top 300 P 61 in laminato H 4 bordo ABS1

300 cm laminate worktop D 61 H 4 with ABS1 edge

Pensile 60 H 72

60 cm wall unit H 72

Cappa 90 "STILO" inox

90 cm "STILO" stainless steel hood

Pensile 60 H 72

60 cm wall unit H 72

Scolapiatti 90 H 72

90 cm plate rack H 72

Asta appendispensili ml 4

4 lm wall unit fixing strip

(Elettrodomestici Hotpoint)

(Hotpoint appliances)