

CREATIVA®



GEOMETRIE IN MOVIMENTO SMOOTH GEOMETRIES

Geometrie in movimento per personalizzare la tua cucina. CREATIVA® è un programma di arredo per chi desidera uno spazio abitativo unico ed esclusivo. Giochi di colori, di materiali e di forme combinabili tra loro per una creatività senza fine.

Il sottile gioco di ombre generate dal doppio spessore, rivoluziona la tradizionale planarità delle ante, esaltando la dinamicità di ogni composizione. Libertà creativa per tutte le tue esigenze di spazio.

Smooth geometries to personalize your kitchen.

CREATIVA® is a furnishing program for those who desire to have a unique and exclusive living space.

A fine movement of shadows generated from double thickness of the door, revolutionizes the flatness of traditional doors, enhancing the dynamism of each composition. Free creativity for all your living space needs.



TECHNICAL FEATURES

WALL UNIT DOORS	16 mm thick door in a mortar effect melamine finish available in the following colours: jute (opt.8863), misty grey (opt.9626), slate grey (opt.9627)
DOORS FOR BASE UNITS, COLUMNS, DRAWERS AND DEEP DRAWERS	16 mm thick rear door with a jute mortar effect melamine finish (opt.8863), mounted with 16 mm thick relief element in soft matt or glossy lacquered MDF 16 mm thick rear door with a fog grey mortar effect melamine finish (opt.9626), mounted with 16 mm thick relief element in soft matt or glossy lacquered MDF 16 mm thick rear door with a slate grey mortar effect melamine finish (opt.9627), mounted with 16 mm thick relief element in soft matt or glossy slate grey lacquered MDF 16 mm thick rear door with a brown oak melamine finish (opt.5320), mounted with 16 mm thick relief element in soft matt or glossy lacquered MDF
WALL UNIT GLASS DOORS	standard: 16 mm thick aluminium frame with a matt oriongrau finish, internal buffered effect and panel, front mounting with coloured tempered 4 mm thick satin-finish glass on request: 16 mm thick aluminium frame with a matt oriongrau finish, internal buffered effect and panel, front mounting with coloured tempered 4 mm thick glass
HANDLES FOR WALL UNITS	without handle, with grip on bottom
HANDLES FOR BASE UNITS, COLUMNS, DRAWERS AND DEEP DRAWERS	integrated in door Note: doors from H 96 to H 204 are supplied complete with two "couplers", which are visible from the inside
CARCASSES	<p>DOOR: jute mortar effect +lacquered mink, melamine-coated mink (opt.948M), mink back panel and shelf (opt.948M)</p> <p>DOOR: mortar effect misty grey +lacquered pearl grey melamine-coated white (opt.001), white back panel and shelf (opt.001)</p> <p>DOOR: mortar effect slateboard+lacquered slateboard melamine-coated slate grey (opt.9620), slate grey back panel and shelf (opt.9620)</p> <p>on request: melamine-coated oriental pearl (opt.940), white back panel and shelf (opt.001) melamine-coated mud (opt. 8860), mud back panel and shelf (opt.8860)</p>
SHELVES	standard: height 3.8 cm available to match structure: mink (opt.948M), white (opt.001), devalè with grafis finish (opt.796), slate grey (opt.9620), oriental pearl (opt.940), mud (opt.8860) on request: height 3.8 cm laminated as door in oak and mortar effect melamine finish
PLINTHS	standard: height 15 cm, melamine-faced PVC with steel (opt.407) or satin-finish aluminium (opt.405) finish on request: height 15 cm in matt and glossy lacquered PVC. For finishes and surcharges see page 55 height 15 cm, in smooth aluminium with brill finish (opt.412), oxidised titanium (opt.414), see surcharges on page 55

cod. **C01**

melaminico effetto malta+laccato
melamine mortar effect+lacquered

CREATIVA®

ante pensili solo presa maniglia sul fondo **wall unit doors** only handle grip on bottom

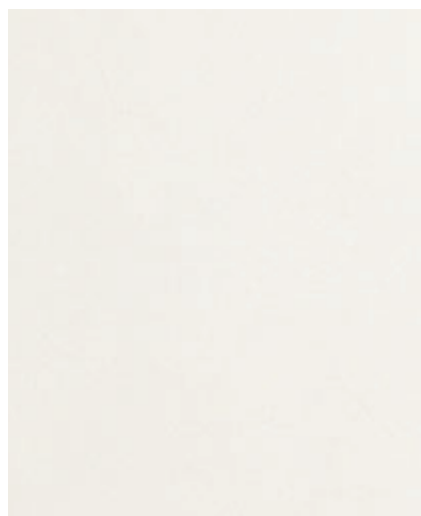

grigio nebbia (opz.9626)
fog grey



juta (opz.8863)
jute

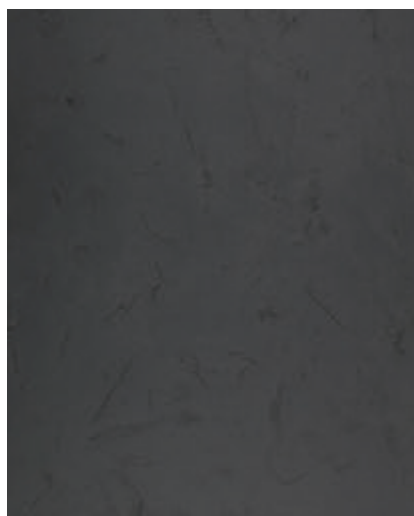

lavagna (opz.9627)
slate grey

SP. 16 MM

N.B.: ulteriori finiture disponibili per le ante pensili:

laccate opache o lucide vedi pag.42-43 (consigliato abbinamento con il colore del laccato delle ante basi-colonne)
vetro colorato lucido o satinato vedi pag.45 (consigliato abbinamento con il colore del laccato delle ante basi-colonne)
malta per abbinamenti vedi pag.46-53

Note: additional finishes available for wall unit doors:

matt lacquered or glossy lacquered see page 42-43
(recommended matching with the lacquered finish of the base unit-column doors)
glossy or satin coloured glass see page 45
(recommended matching with the lacquered finish of the base unit-column doors)
mortar for combinations see page 46-53



16

ante basi - colonne **n.b.: è possibile abbinare ad ogni melaminico un qualsiasi colore laccato**
base unit-column doors **note: every melaminic finish can be matched with every lacquered colour**

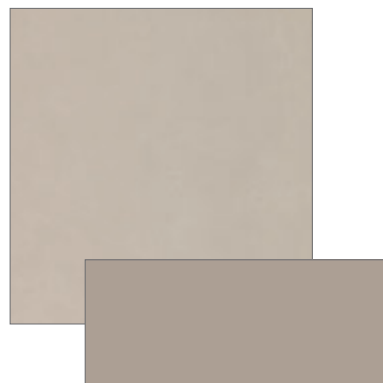
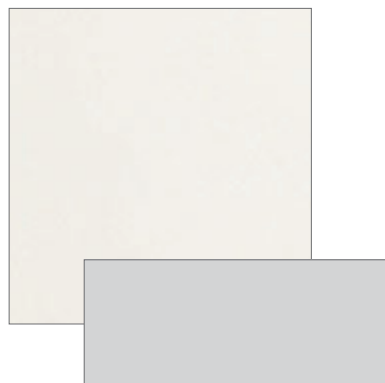

SP. 32 MM

Per disegni tecnici vedi :
"INFORMAZIONI TECNICHE"

For technical drawings see :
"TECHNICAL INFORMATIONS"

CARATTERISTICHE TECNICHE

ANTE PENSILI

anta sp.16 mm in mdf laccata nei colori:

[CLICCA QUI PER LA GAMMA COLORI DISPONIBILI](#)

[CLICK HERE FOR THE RANGE OF AVAILABLE COLORS](#)

[ZUR FARBAUSWAHL HIER KLICKEN](#)

ANTE BASI, COLONNE, CASSETTI E CESTONI

anta sp.32 mm in mdf laccata nei colori:

[CLICCA QUI PER LA GAMMA COLORI DISPONIBILI](#)

[CLICK HERE FOR THE RANGE OF AVAILABLE COLORS](#)

[ZUR FARBAUSWAHL HIER KLICKEN](#)

ANTE VETRO PENSILI

di serie: telaio alluminio sp.16 mm finitura oriongrau matt tamponato internamente con pannello ed assemblato frontalmente con vetro colorato satinato temperato sp.4 mm
a richiesta: telaio alluminio sp.16 mm finitura oriongrau matt tamponato internamente con pannello ed assemblato frontalmente con vetro colorato lucido temperato sp.4 mm

MANIGLIE PER PENSILI

senza maniglia apertura con presa su fondo

MANIGLIE BASI, COLONNE, CASSETTI E CESTONI

integrata sull'anta

N.B.: da H 96 a H 204 le ante vengono fornite complete di due tiranti visibili dall'interno

STRUTTURE

di serie: nobilitato perla d'oriente (opz.940) schiena e ripiano bianco (opz.001)

a richiesta:

nobilitato bianco (opz.001) schiena e ripiano bianco (opz.001)
nobilitato devalè finitura grafis (opz.796) schiena e ripiano bianco (opz.001)
nobilitato visone (opz.948M) schiena e ripiano visone (opz.948M)
nobilitato lavagna (opz.9620) schiena e ripiano lavagna (opz.9620)
nobilitato fango (opz.8860) schiena e ripiano fango (opz.8860)



MENSOLE

di serie: altezza cm 3,8 in laminato bianco (opz.001), perla d'oriente (opz.940), devalè finitura grafis (opz.796) visone (opz.948M), lavagna (opz.9620), fango (opz.8860)

a richiesta: altezza cm 3,8 laccate come anta

ZOCCOLI

di serie: altezza cm 15 in pvc ricoperto in melamina finitura acciaio (opz.407) o alluminio satinato (opz.405)

a richiesta: **a richiesta:** altezza cm 15 in pvc laccati nei colori opachi e lucidi, vedi finiture e maggiorazione pag.55
altezza cm 15 in alluminio liscio finitura brill (opz.412), titanio ossidato (opz.414), vedi maggiorazione pag.55





TECHNICAL FEATURES

WALL UNIT DOORS

16 mm thick MDF lacquered door available in the following colours:

[CLICCA QUI PER LA GAMMA COLORI DISPONIBILI](#)

[CLICK HERE FOR THE RANGE OF AVAILABLE COLORS](#)

[ZUR FARBAUSWAHL HIER KLICKEN](#)

DOORS FOR BASE UNITS, COLUMNS, DRAWERS AND DEEP DRAWERS

32 mm thick MDF lacquered door available in the following colours:

[CLICCA QUI PER LA GAMMA COLORI DISPONIBILI](#)

[CLICK HERE FOR THE RANGE OF AVAILABLE COLORS](#)

[ZUR FARBAUSWAHL HIER KLICKEN](#)

WALL UNIT GLASS DOORS

standard: 16 mm thick aluminium frame with a matt oriongrau finish, internal buffered effect and panel, front mounting with coloured tempered 4 mm thick satin-finish glass
on request: 16 mm thick aluminium frame with a matt oriongrau finish, internal buffered effect and panel, front mounting with coloured tempered 4 mm thick glass

HANDLES FOR WALL UNITS

without handle, with grip on bottom

HANDLES FOR BASE UNITS, COLUMNS, DRAWERS AND DEEP DRAWERS

integrated in door

Note: doors from H 96 to H 204 are supplied complete with two "couplers", which are visible from the inside

CARCASSES

standard: melamine-coated oriental pearl (opt.940), white back panel and shelf (opt.001)
on request: melamine-coated white (opt. 001), white back panel and shelf (opt. 001)
 melamine-coated devalè with grafis finish (opt.796), white back panel and shelf (opt.001)
 melamine-coated mink (opt.948M), mink back panel and shelf (opt.948M)
 melamine-coated slate grey (opt.9620), slate grey back panel and shelf (opt.9620)
 melamine-coated mud (opt.8860), mud back panel and shelf (opt.8860)

SHELVES

standard: height 3.8 cm, in laminate to match structure: white (opt.001), oriental pearl (opt.940), devalè with grafis finish (opt.796)
 mink (opt.948M), slate grey (opt.9620), mud (opt.8860)
on request: height 3.8 cm lacquered same finish as door

PLINTHS

standard: height 15 cm, melamine-faced PVC with steel (opt.407) or satin-finish aluminium (opt.405) finish
on request: height 15 cm in matt and glossy lacquered PVC. For finishes and surcharges see page 55
 height 15 cm, in smooth aluminium with brill finish (opt.412), oxidised titanium (opt.414), see surcharges on page 55

ante pensili
wall unit doors

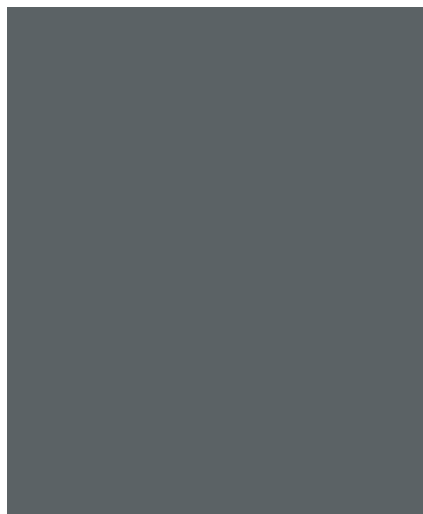

ante pensili
wall unit doors



N.B.: ulteriori finiture disponibili per le ante pensili:
vetro colorato lucido o satinato vedi pag.45 (consigliato abbinamento con il colore del laccato delle ante basi-colonne)

Note: additional finishes available for wall unit doors:
glossy or satin coloured glass see page 45
(recommended matching with the lacquered finish of the base unit-column doors)

N.B.: ante pensili solo presa maniglia sul fondo
NOTE: wall unit doors only with handle grip on bottom

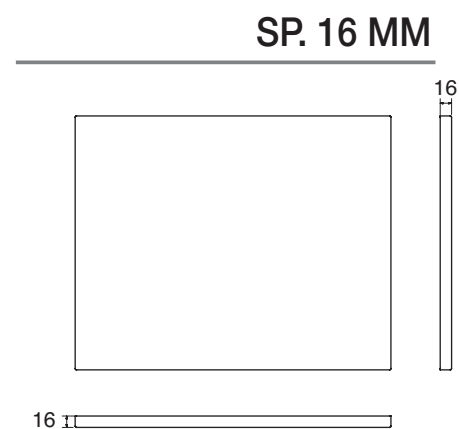

ante basi - colonne
base unit-column doors

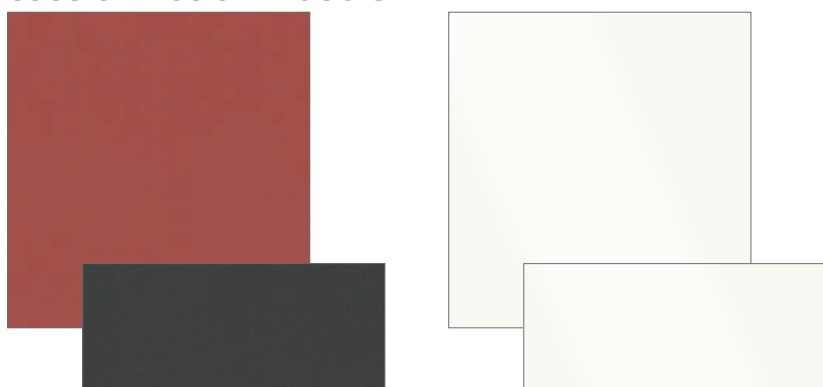

ante basi - colonne
base unit-column doors



n.b.: gli abbinamenti dei colori riportati sono puramente indicativi
è possibile abbinare qualsiasi colore laccato (vedi colori pag.42-43)
note: the colours matches are purely indicative
it is possible to match every lacquered colour (see colour page 42-43)





cod. **C03** opaca matt

CREATIVA®

colori testurizzati soft soft textured colours

 [CLICCA QUI PER LA GAMMA COLORI DISPONIBILI](#)

 [CLICK HERE FOR THE RANGE OF AVAILABLE COLORS](#)

 [ZUR FARBAUSWAHL HIER KLICKEN](#)

cod. **C03** lucida glossy

CREATIVA®

laccato lucido **DIRETTO** GLOSSY LACQUERED

 [CLICCA QUI PER LA GAMMA COLORI DISPONIBILI](#)

 [CLICK HERE FOR THE RANGE OF AVAILABLE COLORS](#)

 [ZUR FARBAUSWAHL HIER KLICKEN](#)

cod.

C04

vetro glass (N.B.: solo per ante pensili)

NOTE: for wall unit doors only

CREATIVA®

VETRO COLORATO COLOURED GLASS

ante telaio oriongrau vetri lucidi o satinati

doors with oriongrau frame and glossy or satin glass

SP. 16 MM



vetro rosso toscano satinato (opz.T8157)
tuscan red satin glass



particolare retro anta oriongrau
detail of the back side of the door,
oriongrau colour

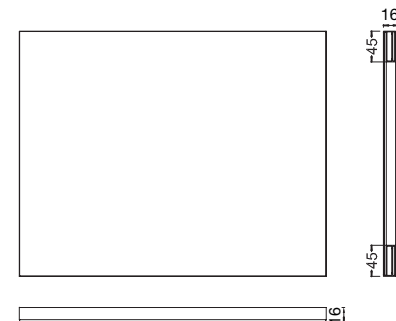

Particolare lato esterno
detail of outside

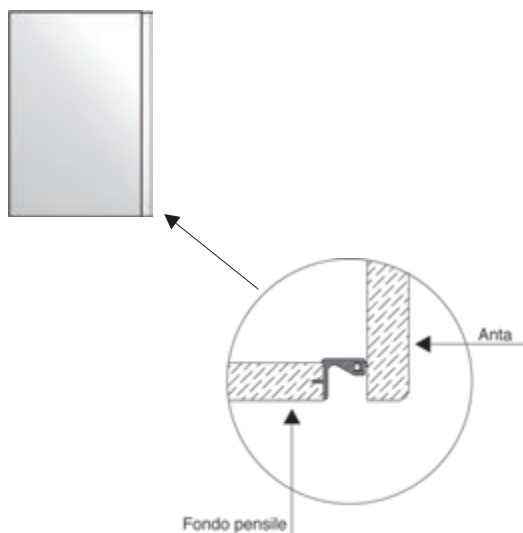

N.B.: apertura con presa maniglia
sul fondo
note: opening system with handle
grip on bottom

colori vetri satinati satin glass colours



bianco assoluto
(opz.V740S)
absolute white

cenere
(opz.V9547)
ash

grigio bromo
(opz.V9533)
bromine grey

nero (opz.V7892)
black

bianco caldo
(opz.V7401)
warm white

canapa (opz.V8531)
hemp



castoro (opz.V8907)
beaver

fumo (opz.V9531)
smoke

grigio piombo
(opz.V9537)
lead grey

bistro (opz.V9535)
bistro

verde lichene
(opz.V8463)
lichen green

verde positano
(opz.V8471)
positano green

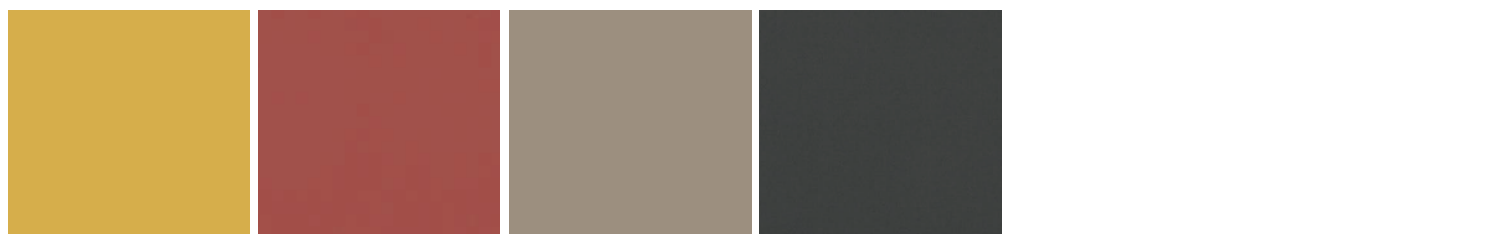

giallo ambra
(opz.V327S)
amber yellow

rosso toscano
(opz.V8157)
tuscan red

bronzo (opz.V8903)
bronze

lavagna (opz.V9543)
slate grey

colori vetri lucidi glossy glass colours



bianco assoluto
(opz.V741)
absolute white

cenere
(opz.V9548)
ash

grigio bromo
(opz.V9534)
bromine grey

nero (opz.V7893)
black

bianco caldo
(opz.V7402)
warm white

canapa (opz.V8532)
hemp

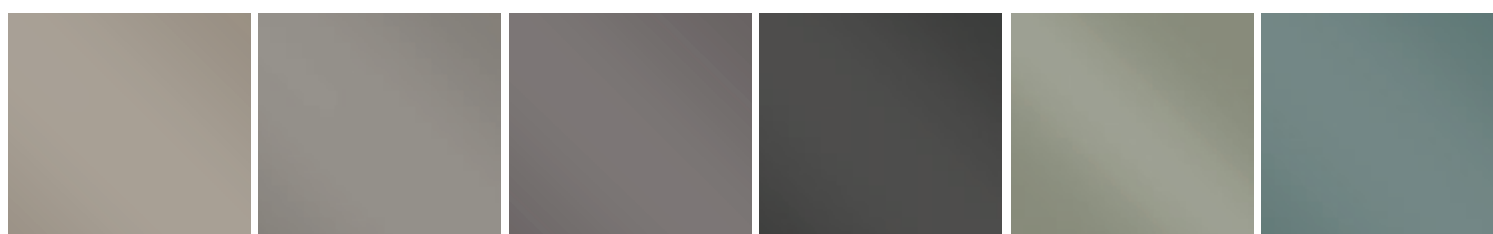

castoro (opz.V8908)
beaver

fumo (opz.V9532)
smoke

grigio piombo
(opz.V9538)
lead grey

bistro (opz.V9536)
bistro

verde lichene
(opz.V8464)
lichen green

verde positano
(opz.V8472)
positano green

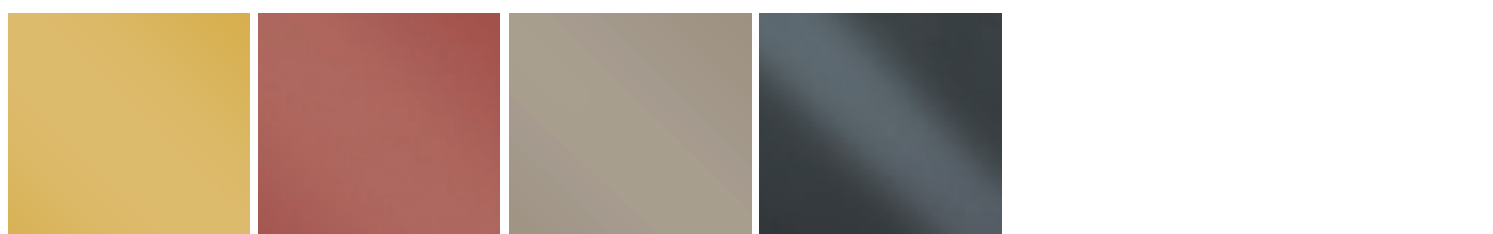

giallo ambra
(opz.V328)
amber yellow

rosso toscano
(opz.V8158)
tuscan red

bronzo (opz.V8904)
bronze

lavagna (opz.V9544)
slate grey

 [CLICCA QUI PER LA GAMMA DEI VETRI TELAIO ALLUMINIO](#)

 [CLICK HERE FOR THE RANGE OF ALUMINIUM FRAMED GLASS](#)

cod. **C06** ante malta tinta unita **(N.B.: solo per ante pensili)**
mortar solid colour doors **NOTE: for wall unit doors only**

opz. 9543M effetto materico tinto lavagna
opz. 9543M material effect stained slate grey

CREATIVA®

anta in mdf lavorata con malta naturale a base di calce sp.16 mm

mdf door worked with mortar natural lime Th. 16 mm

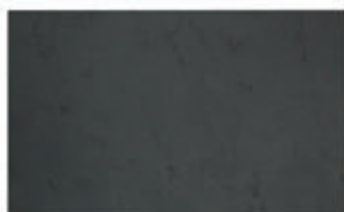

anta 35,7x59,6
door 35,7x59,6



anta 35,7x89,6
door 35,7x89,6



anta 35,7x119,6
door 35,7x119,6



anta 59,7x59,6
door 59,7x59,6

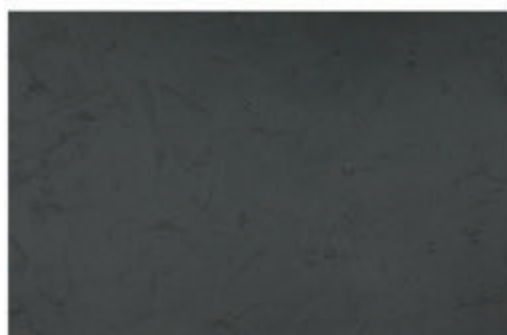

anta 59,7x89,6
door 59,7x89,6

da abbinare all'anta
malta lavagna + lavagna
to be combined with the
slate grey mortar + slate grey door

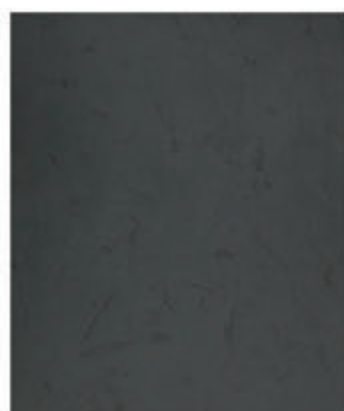

anta 71,7x59,6
door 71,7x59,6

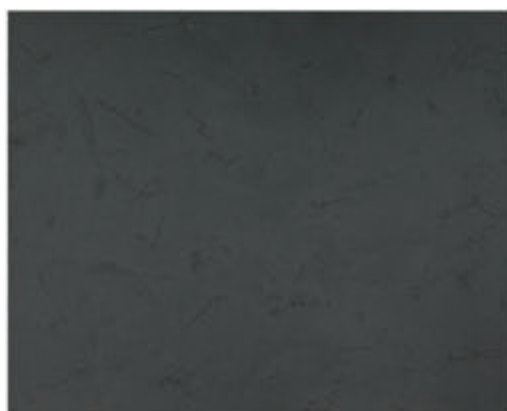

anta 71,7x89,6
door 71,7x89,6

N.B.: il retro dell'anta è laccato opaco lavagna **NOTE: the door rear is matt slate grey lacquered**

MECCANISMI MOTORIZZATI SERVO-DRIVE

SERVO-DRIVE MOTORISED
MECHANISMS

CREATIVA®

Estrema facilità di apertura e chiusura ante
Extreme ease in opening and closing the doors

N.B.: il SERVO-DRIVE non può essere installato
successivamente ma deve essere richiesto
contemporaneamente all'ordine del pensile.

Motorizzato SERVO-DRIVE (Opz.007)

NOTE: SERVO-DRIVE cannot be installed
at a later date but must be ordered
at the same time as the wall unit.

SERVO-DRIVE motorised (Opt.007)

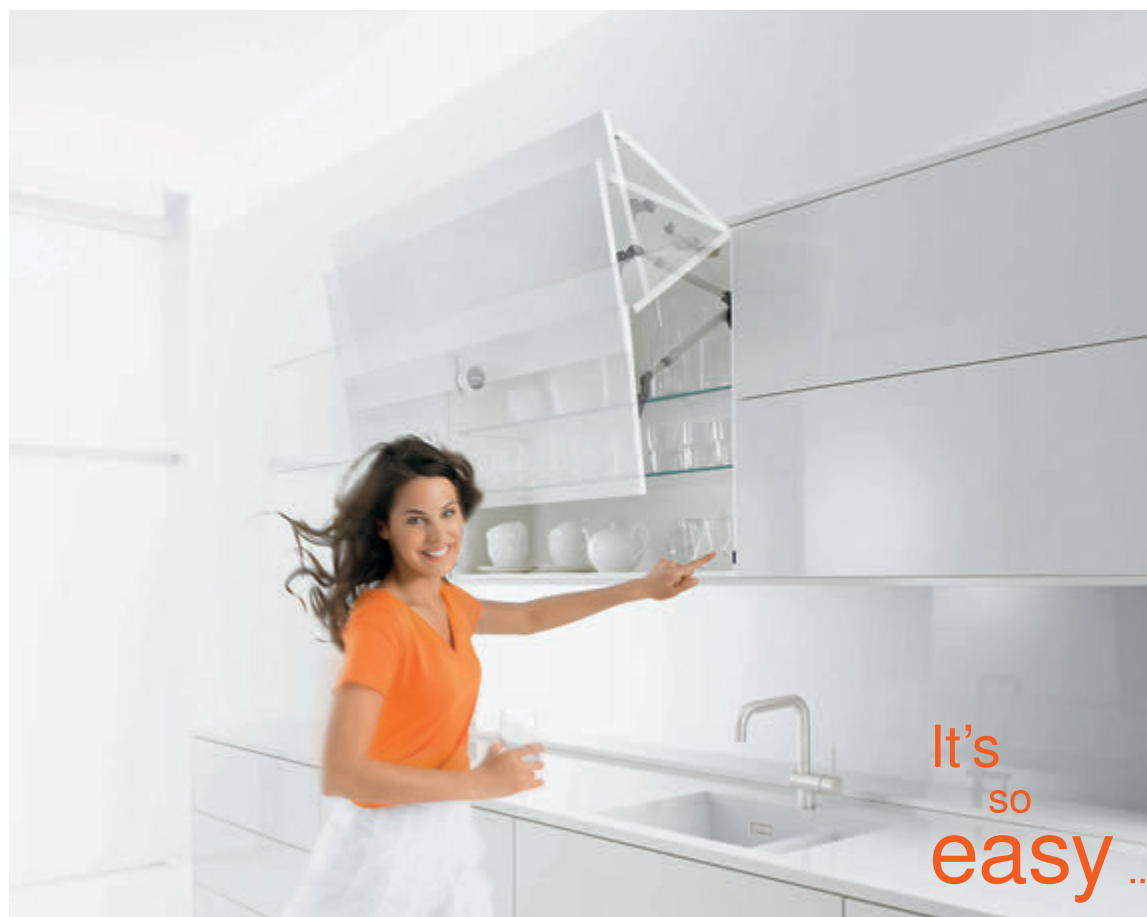

APERTURA ANTE A PACCHETTO
LIFT-UP FOLDING DOOR OPENING



APERTURA VERTICALE OBLIQUA
OBLIQUE VERTICAL OPENING



APERTURA RIBALTA
FLAPDOOR OPENING



APERTURA VERTICALE
VERTICAL OPENING



ESTREMAMENTE FACILE DA UTILIZZARE

EXTREMELY EASY TO USE

CREATIVA®



Grazie a SERVO-DRIVE basta una leggera pressione sul fronte con la mano o il gomito per aprire automaticamente le ante a ribalta.

Persino i frontali grandi e pesanti si aprono verso l'alto come in totale assenza di gravità.

Inoltre, l'utilizzatore della cucina può godere di un accesso ottimale all'interno del mobile.

Thanks to SERVO-DRIVE, just apply light pressure to the front panel with the hand or elbow to automatically open the folding doors.

Even large front panels open upwards with a complete lack of gravity. In addition, the opening provides optimum access to the cabinet interior.



Chiusura comoda e semplice, assicurata dall'interruttore facilmente raggiungibile, montato sul fianco del corpo mobile.

Le chiusure delle ante a ribalta risulta così estremamente comoda ed ergonomica, mentre la rinomata funzione BLUMOTION garantisce una chiusura dolce e silenziosa.

Simple and convenient to close using an easy-to-reach switch fitted on the side of the cabinet.

Closing the folding doors is so easy, convenient and ergonomic. The renowned BLUMOTION function also ensures gentle and silent closing.



KIT TRASFORMATORE

POWER SUPPLY KIT

CREATIVA®

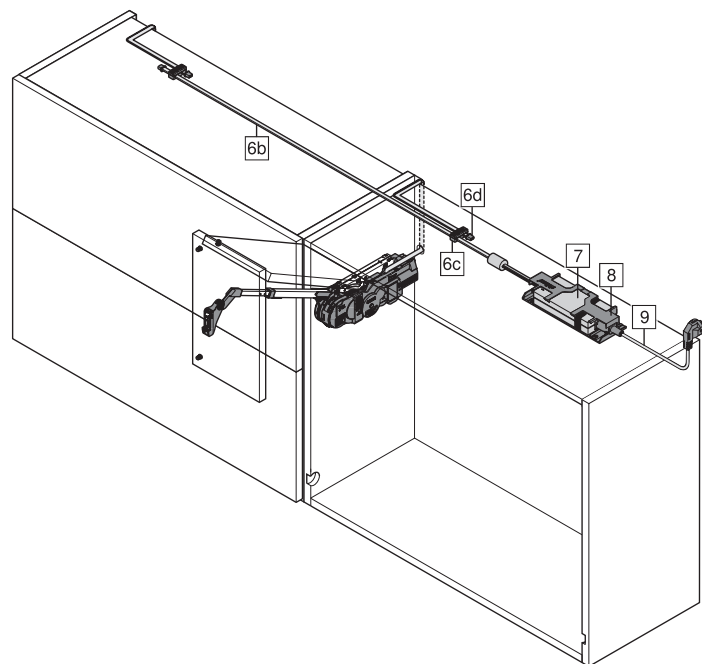

Kit trasformatore composto da:
Power supply kit comprised of:

- 6b** Cavo di distribuzione lunghezza 8 mt
Power supply cable length 8 m
 - 6c** 1 Connettore
Connector
 - 6d** Protezione estremità cavo
Cable end protection
 - 7** Trasformatore universale per tutti paesi del mondo
72 W completo di supporto per il montaggio
Universal power supply for all countries in the world
72 W complete with mounting bracket
 - 8** Supporto trasformatore
Power supply mounting bracket
 - 9** Cavo di alimentazione elettrica UE
EU electrical power supply cable
- i** Per ogni cavo di distribuzione può essere collegato un solo trasformatore Blum.
Only one Blum power supply may be connected to each power supply cable.

Per il meccanismo elettrico motorizzato SERVO-DRIVE richiedere sempre il kit trasformatore, codice 5615850 - € 190.
Un trasformatore può alimentare fino a 10 motori.

N.B.: si potrebbero verificare situazioni dove alimentare fino a 10 motori.

For the motorised electric SERVO-DRIVE mechanism, always request the power supply kit: code 5615850 - € 190

One power supply can power up to 10 motors.

NOTE: situations may arise that require the use of more than one power supply kit.

PENSILI SU PARETI CONTINUE

CONTINUOUS WALL UNITS

COMPOSIZIONE "A"

COMPOSITION "A"

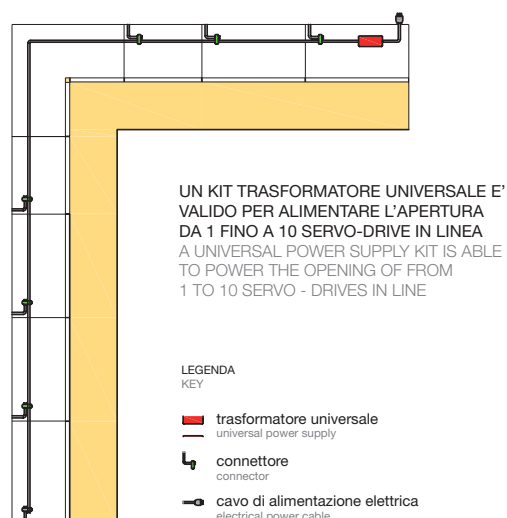

PENSILI SU PARETI SEPARATE

SEPARATE WALL UNITS

COMPOSIZIONE "B"

COMPOSITION "B"

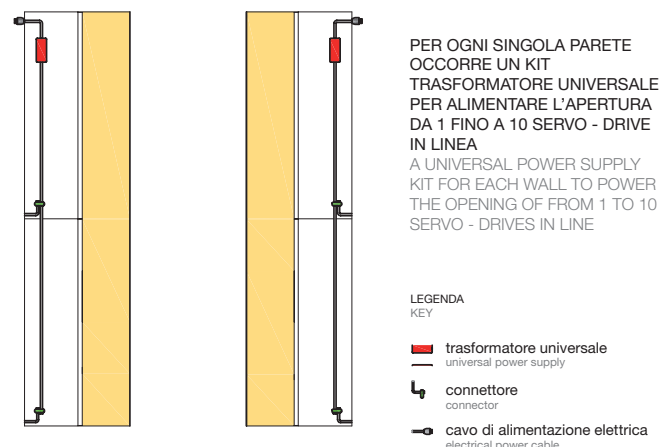



APERTURA VERTICALE OBLIQUA

I pensili con questo tipo di meccanismo necessitano per l'apertura di poco spazio libero sopra il mobile grazie al movimento basculante dell'anta che si apre senza difficoltà applicando poca forza anche in presenza di frontali pesanti. Con l'arresto progressivo le ante si fermano in qualsiasi posizione; in questo modo la maniglia è sempre facilmente raggiungibile. La chiusura è ammortizzata ed è possibile regolare la forza di tenuta in base al peso del frontale.

VERTICAL OPENING OBLIQUE

Wall units that mount this type of mechanism require little clearance above the cabinet thanks to the swivelling movement of the door that can be easily opened by applying slight pressure, even with heavy fronts. The doors stop in any position thanks to the gradual stopping movement; in this way, the handle is always easily accessible. The closing movement is cushioned and the closing force can be adjusted according to the weight of the front door.



**DI SERIE
STANDARD**



**MOTORIZZATO
SERVO-DRIVE
SERVO-DRIVE
MOTORISED
(Opz.007)**

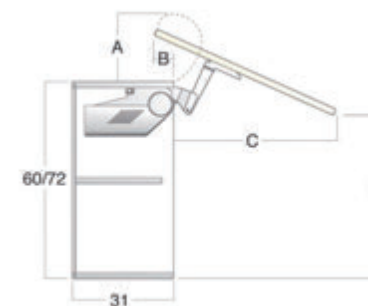

	A	B	C	D
H 60	18	9,6	46,5	53,5
H 72	18	9,6	57	61

APERTURA VERTICALE

L'anta ad apertura verticale, potendo essere sollevata completamente verso l'alto, consente un accesso totale all'interno del pensile. Ideale per l'impiego in mobili a colonna per nascondere ad esempio apparecchi elettrici, o pensili con corpi mobili sovrastanti, ha la chiusura ammortizzata e la possibilità di regolare la forza di tenuta in base al peso del frontale.

VERTICAL OPENING

Doors with vertical opening movement can be fully raised to fully access the inside of the wall unit.

Ideal for use on column units to conceal electrical appliances for examples, or on wall units surmounted by mobile units.

The closing movement is cushioned and the closing force can be adjusted according to the weight of the front door.



**DI SERIE
STANDARD**



**MOTORIZZATO
SERVO-DRIVE
SERVO-DRIVE
MOTORISED
(Opz.007)**

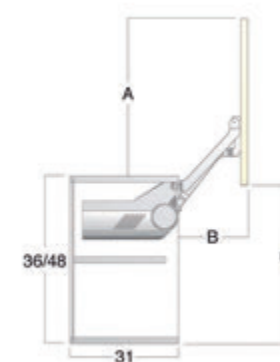

	A	B	C
H 36	34	23,5	34,5
H 48	43	28,5	43,5



PENSILE CON APERTURA ANTE A PACCHETTO

Il meccanismo d'apertura ante a pacchetto è idoneo sia sul pensile H 72 che H 96; la regolazione della forza di apertura può essere impostata in modo esatto in base ai pesi dei frontali, la chiusura è ammortizzata e la cerniera centrale clip si contraddistingue per l'innovativa tecnologia che garantisce la sicurezza per le dita.

WALL UNIT WITH LIFT-UP FOLDING DOOR

The lift-up folding door opening mechanism is suitable for wall units with H 72 or H 96; the opening force can be adjusted precisely according to the weight of the fronts, while the closing movement is cushioned and the central clip-on hinge features innovative technology for safeguarding the fingers.



DI SERIE STANDARD

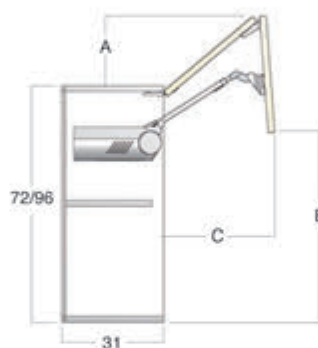

	A	B	C
H 72	16,5	54	41
H 96	20	69	53

SCHEMA MONTAGGIO LIMITATORE LIMITER INSTALLATION DIAGRAM

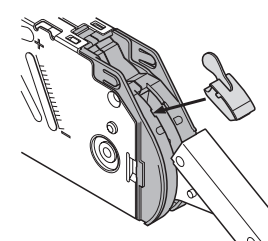
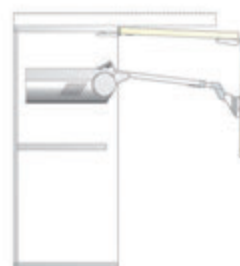

MOTORIZZATO SERVO-DRIVE SERVO-DRIVE MOTORISED



Per evitare l'interferenza dell'anta in fase di apertura con cornici o mensole, si può richiedere il limitatore dell'angolo di apertura cod. 5620005

In order to avoid that the door interferes with cornices or shelves during the opening movement, it is possible to request an opening angle limiter: code 5620005

PENSILE CON APERTURA A RIBALTA

Le ante aprendosi verso l'alto consentono di avere un' ampia visione d'insieme all'interno del mobile. In questo modo è possibile un comodo accesso agli oggetti contenuti al suo interno e, dal punto di vista ergonomico, molto vantaggioso. La regolazione della forza di apertura può essere impostata in modo esatto in base al peso del frontale. Grazie all'arresto progressivo le ante si fermano in qualsiasi posizione; in questo modo la maniglia è sempre facilmente raggiungibile. La chiusura è ammortizzata e un'unica manovra è sufficiente per regolare il frontale tridimensionalmente grazie all'assenza di cerniere e al sistema di aggancio clip.

WALL UNIT WITH FLAP DOOR

The doors that open upwards guarantee ample overall visibility inside the cabinet. In this way, all objects housed inside the cabinet can be comfortably accessed, making the system highly advantageous from an ergonomic perspective. The opening force can be adjusted precisely depending on the weight of the front. The doors stop in any position thanks to the gradual stopping movement; in this way, the handle is always easily accessible. The closing movement is cushioned and a single manoeuvre is required to three-dimensionally adjust the front, thanks to the clip-on system and the absence of hinges.



DI SERIE STANDARD

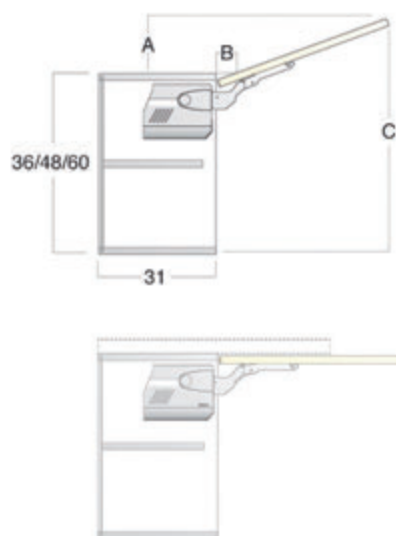

	A	B	C
H 36	11,5	3,5	37
H 48	15	3,5	49
H 60	18,5	3,5	61

Per evitare l'interferenza dell'anta in fase di apertura con cornici o mensole, si può richiedere il limitatore dell'angolo di apertura cod. 5620010

In order to avoid that the door interferes with cornices or shelves during the opening movement, it is possible to request an opening angle limiter: code 5620010

MOTORIZZATO SERVO-DRIVE SERVO-DRIVE MOTORISED (Opz.007)



SCHEMA MONTAGGIO LIMITATORE PER RIBALTA H 36
FLAP DOOR LIMITER INSTALLATION DIAGRAM H 36

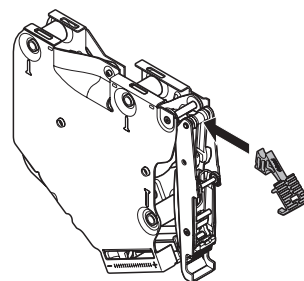

SCHEMA MONTAGGIO LIMITATORE PER RIBALTA H 48
FLAP DOOR LIMITER INSTALLATION DIAGRAM H 48

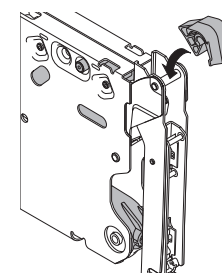

INFORMAZIONI TECNICHE TIRAMIGIÙ

TECHNICAL INFORMATION TIRAMIGIÙ

Tiramigiù è un meccanismo a traslazione verticale servoassistita da motore elettrico.

Il tiramigiù esprime una funzionalità inedita che accorcia ulteriormente le distanze dall'uomo: infatti, grazie ad un particolare sistema meccanico - elettrico che si attiva con la completa apertura dell'anta, scende all'altezza della persona per porgere gli oggetti contenuti al suo interno, permettendo al contempo un'ulteriore ottimizzazione degli spazi con lo sfruttamento di altezze prima non fruibili e una drastica riduzione di azioni e movimenti correlati. Disponibile anche nella versione elettronica con telecomando.

N.B. : lo schienale tra basi e pensili non deve superare 2 cm di spessore.

Utilizzare il rubinetto sotto finestra

Tiramigiù is a servo-aided vertical sliding mechanism powered by a remote controlled electric motor.

Tiramigiù expresses innovative functionality that eliminates the barriers with man: thanks to a special mechanical-electronic system equipped with remote controlled switch, the device lowers down to the user's height to facilitate access to the objects inside it; at the same time, space can be further optimised by exploiting previously unused upper spaces while drastically reducing the required manoeuvres and movements. Electronic version with remote control is also available.

Note: the back panel between base and wall units, should not exceed 2 cm thickness.

Use the under-window tap

Tiramigiù alzato

Raised Tiramigiù



Tiramigiù abbassato

Lowered Tiramigiù



**corsa regolabile
fino a 54 cm**
adjustable moves
up to 54 cm



COMPOSIZIONE CON ELEMENTI INCLINATI

COMPOSITION WITH INCLINED ELEMENTS

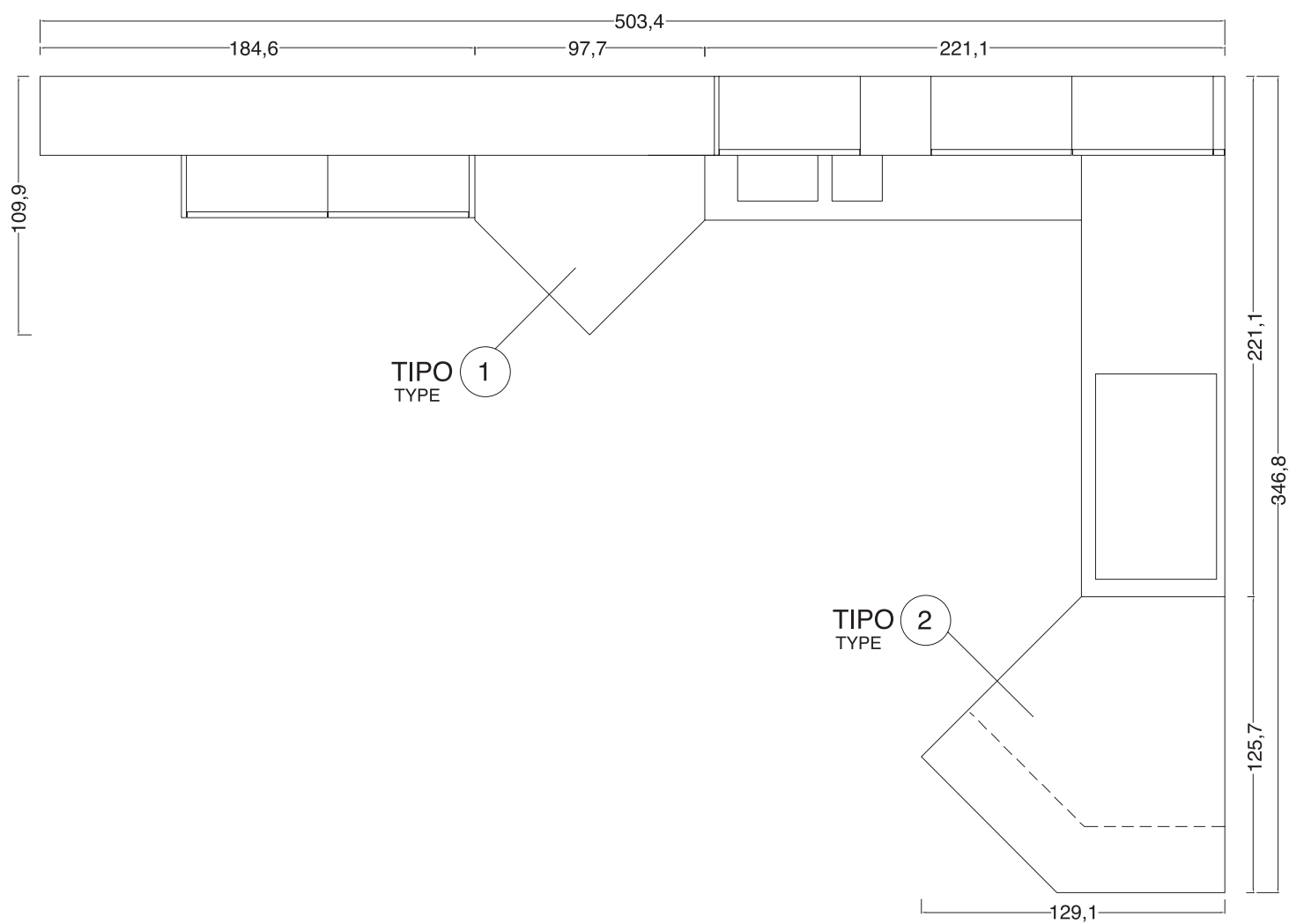
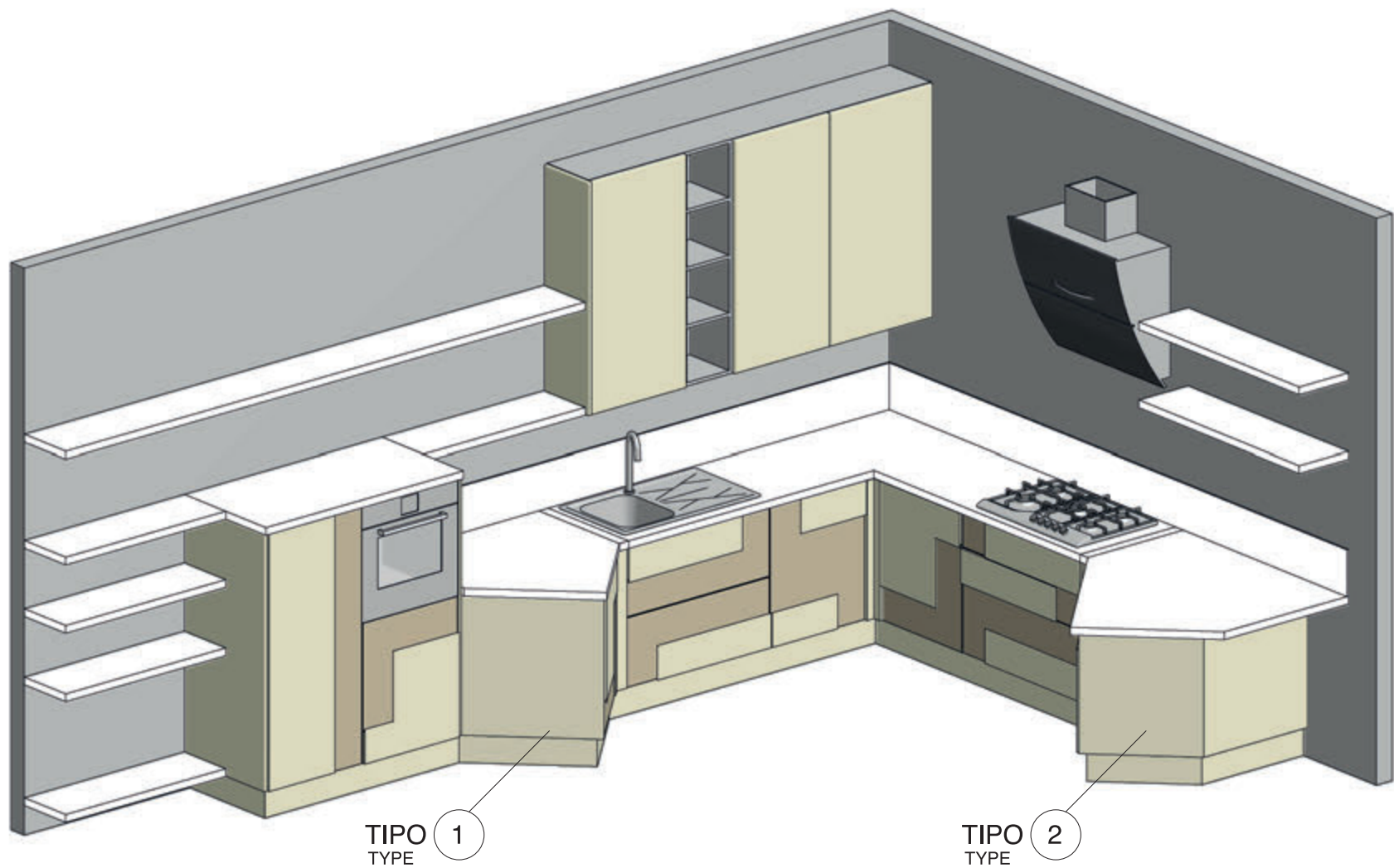

COLONNA 180 H 219 P 71,4 CON ANTE COMPLANARI

COLUMN 180 H 219 D 71,4 WITH SLIDING DOORS

COLONNA 180 H 219 P 71,4 CON ANTE COMPLANARI

Alla colonna da 180 H 219 P 71,4 si possono affiancare le colonne profondità 60,9 utilizzando a fine composizione il fianco di finitura laccato come anta con scasso da 204x71,4

LACCATO OPACO sp. 1,9 con scasso codice 1C03V4115 € 512 cadauno

LACCATO LUCIDO sp. 1,9 con scasso codice 1C03V4115 € 600 cadauno

COLUMN 180 H 219 D 71,4 WITH SLIDING DOORS

Next to column 180 H 219 D 71,4, one can add a normal depth column 60,9 using a deeper finishing lacquered same as door with lateral including cut 204x71,4 at the end of the composition

MATT LACQUERED th. 1,9 with lateral including cut cod.1C03V4115 EACH € 512

GLOSSY LACQUERED th. 1,9 with lateral including cut cod.1C03V4115 EACH € 600

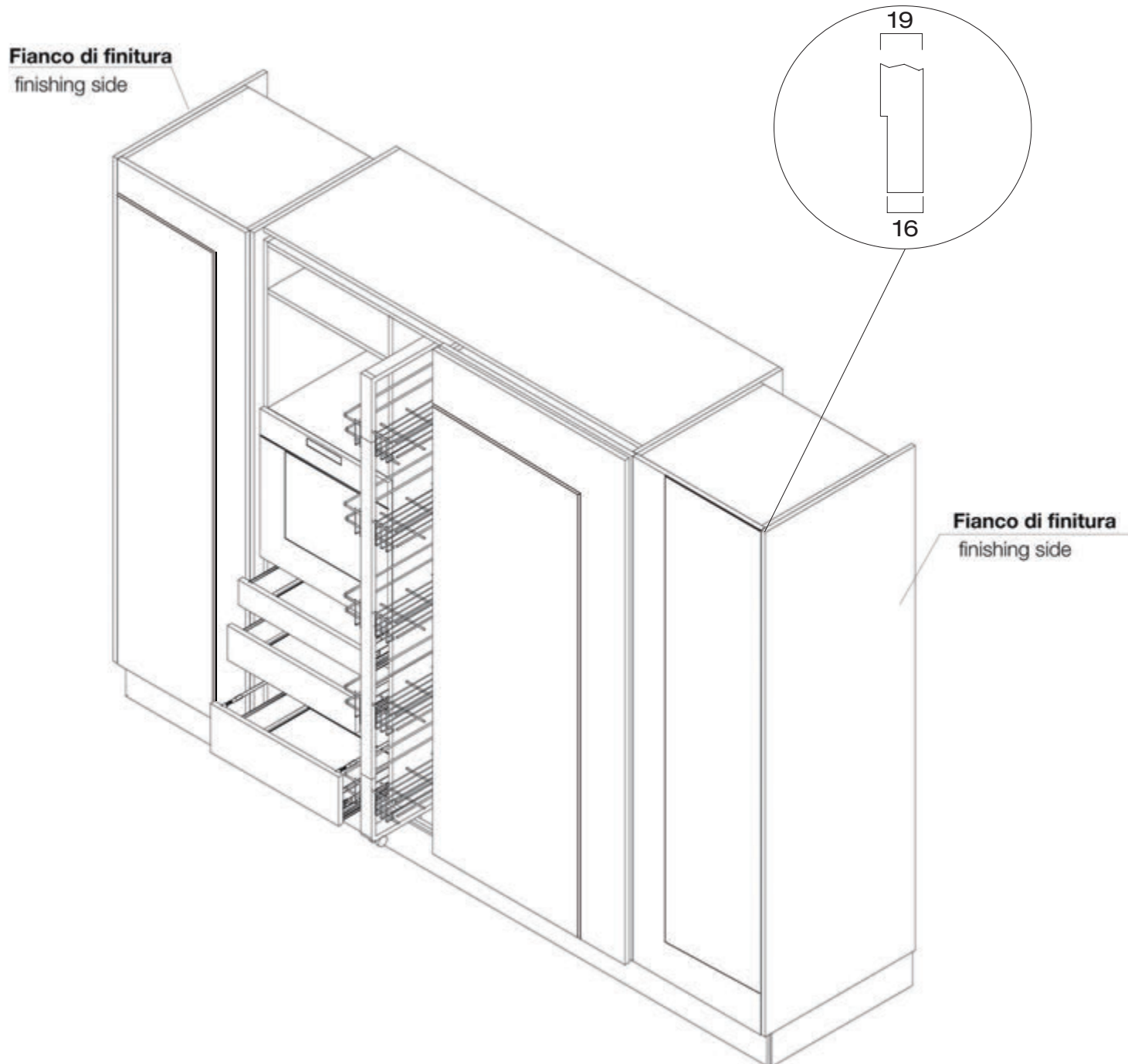



ELEMENTI A GIORNO IN LAMIERA VERNICIATI A POLVERE SP.2 MM

POWDER PAINTED METAL SHEET OPEN UNITS TH.2 MM



colori opachi
matt colours

<p>bianco assoluto (opz.740S) absolute white</p>	<p>castoro (opz.8907) beaver</p>	<p>acquamarina (opz.8323) aquamarine</p>	<p>giallo ambra (opz.8225) amber yellow</p>	<p>rosa quarzo (opz.8171) quartz pink</p>	<p>verde acqua (opz.8473) water green</p>
<p>rosso corallo (opz.8131) coral red</p>	<p>salvia (opz.8443) sage</p>	<p>grigio bromo (opz.9533) bromine grey</p>	<p>bianco caldo (opz.7401) warm white</p>	<p>fumo (opz.9531) smoke</p>	<p>verde positano (opz.8471) positano green</p>
<p>nero (opz.7892) black</p>	<p>rosso toscano (opz.8157) tuscan red</p>	<p>titanio (opz.414) titanium</p>	<p>grigio nebbia (opz.9551) fog grey</p>	<p>blu cadetto (opz.8373) cadet blue</p>	<p>verde lichene (opz.8463) lichen green</p>



ELEMENTI A GIORNO

OPEN UNITS



colori disponibili per elementi a giorno laccati opaco soft
colours available for soft matt lacquered open units

[👉 CLICCA QUI PER LA GAMMA COLORI DISPONIBILI](#)

[👉 CLICK HERE FOR THE RANGE OF AVAILABLE COLORS](#)

[👉 ZUR FARBAUSWAHL HIER KLICKEN](#)

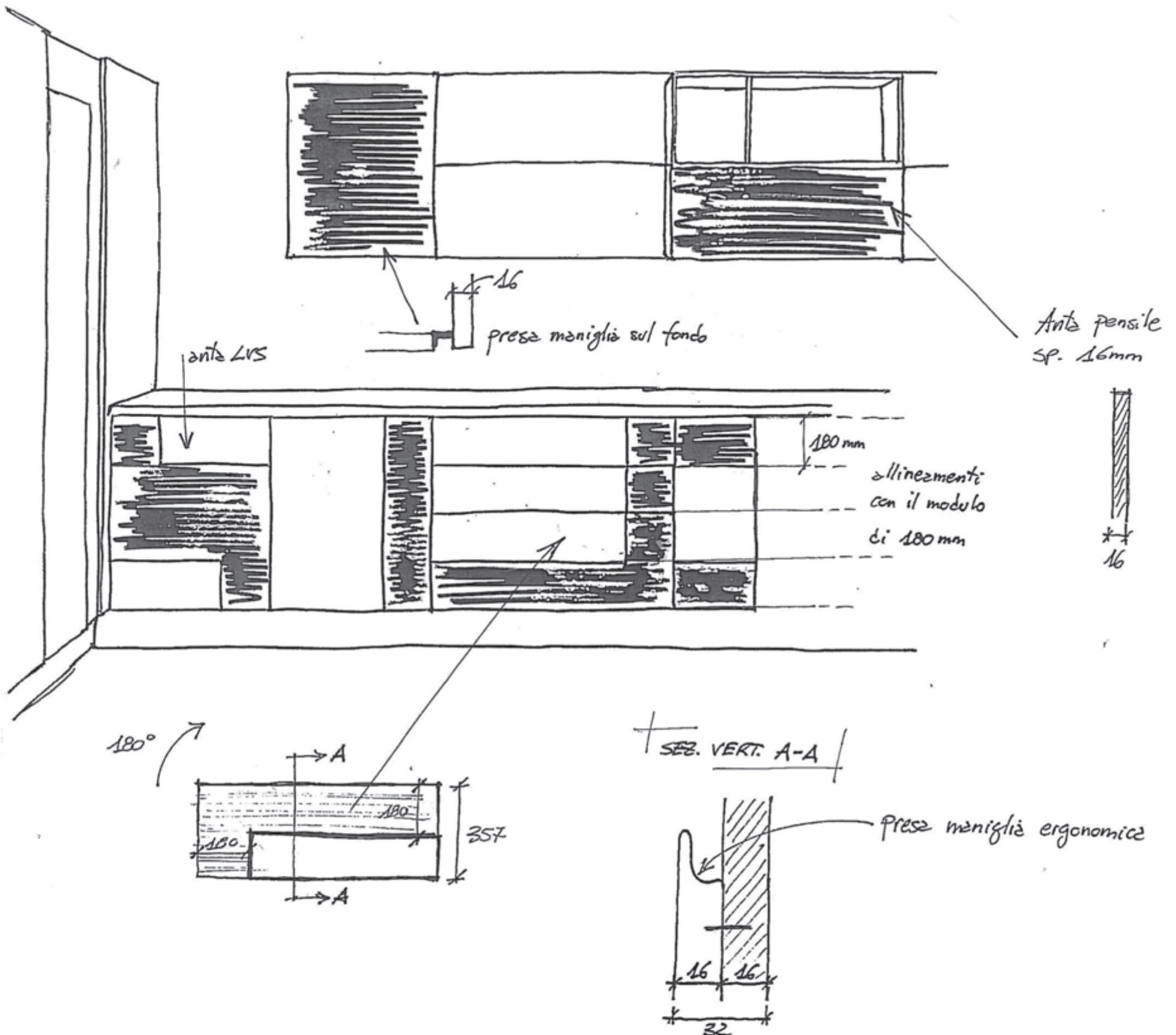

Con **CREATIVA®**, in **fase di progettazione** l'immagine complessiva della stessa composizione può essere personalizzata secondo il proprio gusto estetico seguendo semplici regole che rendono unica la tua cucina.

Come è composta l'anta

Tecnicamente le ante di **basi, cassetti, cestoni** e **colonne** sono realizzate assemblando un pannello sp.16 mm con un altro dello stesso spessore che diventa la maniglia stessa dell'anta. Per un totale quindi di 32 mm. Per questo motivo rispetto ad un tradizionale modello LUBE moderno, tutte le ante di **CREATIVA®** (fatta eccezione per le ante dei pensili), risultano più strette in larghezza di 2 mm.

E' stata studiata inoltre un' apposita cerniera con ammortizzatore integrato e basetta per alto spessore che si contraddistingue dalle altre per un piccolo segmento a rilievo posto sopra il corpo della cerniera stessa.

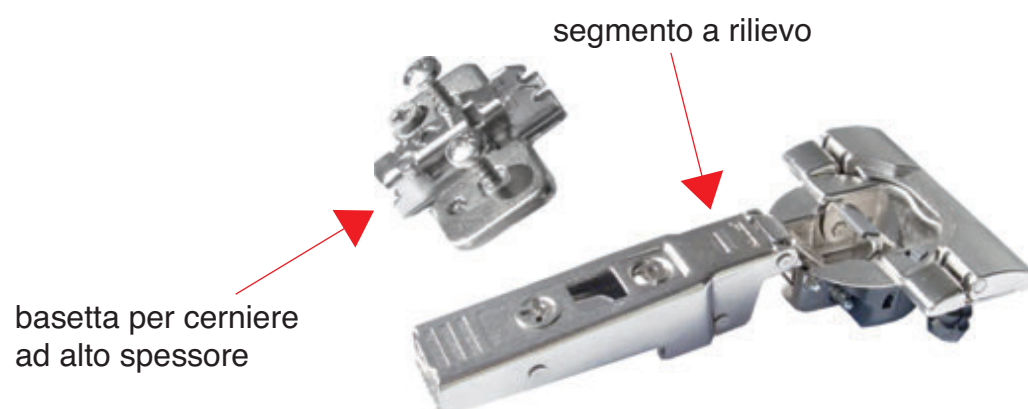

Tutti i moduli di **CREATIVA®** montano di serie questa nuova cerniera, ad eccezione dell'anta frigo, dei mobili ad angolo e delle ante dei pensili. L'anta **pensile** infatti, è semplicemente un pannello sp.16 mm esclusivamente con presa maniglia sul fondo.

Regole per una corretta progettazione

• Ante basi e colonne con cerniere

Ogni anta è stata studiata per garantire sempre un'apertura ergonomica. Ne esistono perciò diversi tipi pensati in funzione della tipologia del mobile e delle sue dimensioni.

Per quanto riguarda le basi la scelta di alcuni tipi di anta è vincolata, mentre per altri il Cliente può decidere secondo il proprio gusto estetico.

Il “disegno” di queste tipologie ha poi il verso DX-SX obbligato come è chiaramente illustrato nelle schede tecniche seguenti.

Le ante colonna invece, sono contraddistinte da un solo tipo necessario per consentire la corretta apertura.

• Ante cassette e cestoni

A differenza delle ante di basi e colonne, in **fase di progettazione** il singolo cassetto o cestone può assumere due differenti “versi” con una rotazione di 180°. In questo caso non esistono quindi tipologie di ante, ma si parla semplicemente di rotazione dell'anta stessa.

La scelta del “verso” diventa perciò un motivo puramente estetico che il Cliente può decidere senza alcun vincolo legato alle aperture.

With **CREATIVA®**, during the **design phase** the overall view of the same composition can be customised to suit personal tastes by observing a few basic rules that make your kitchen unique.

Composition of the doors

Technically speaking, the doors of **base units, drawers and deep drawers** are manufactured by assembling a 16 mm thick panel together with another panel of the same thickness which becomes the door handle. The final thickness is thus 32 mm.

As a result, compared to a traditional modern LUBE model, all the **CREATIVA®** doors (except for wall units doors) are smaller in width by 2 mm. Moreover, a special hinge was designed with incorporated shock-absorber and high-thickness base plate that, compared to other hinges, includes a small relief segment above the hinge body.

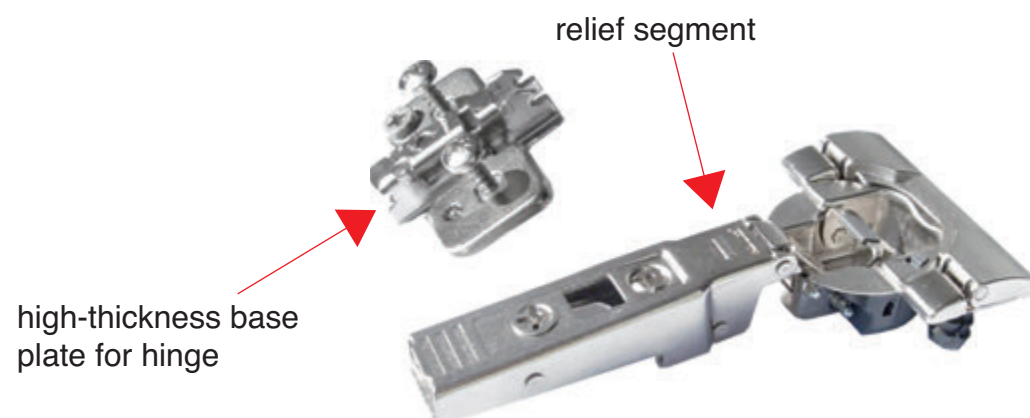

All **CREATIVA®** modules are equipped with this new hinge as a standard feature, except for the doors mounted on fridges, corner cabinets and wall units. The door **wall unit** basically consists of a 16 mm thick panel exclusively with the handle grip on the bottom.

Rules for correct design

• **Base unit and column doors with hinges**

Each door is designed to guarantee ergonomic opening.

As a result, several different types are available depending on the type of the cabinet and the latter's size.

With regard to base units, the choice of certain door types is binding, while for others, the Customer may select according to personal taste.

The “design” of these door types has a mandatory RH-LH direction, as clearly illustrated in the following technical sheets.

On the other hand, the column doors are distinguished by a single type necessary to ensure their correct opening.

• **Drawer and deep drawer doors**

Unlike base unit and column doors, during the design phase the single drawer or deep drawer can open in two different “directions” with 180° rotation.

In this case, therefore, the type of door is irrelevant: we speak about the door rotation instead.

The Customer thus selects the door “direction” based on aesthetic considerations alone, without any constraints as to the door opening.

ANTE TIPO 1 (H 72) doors type 1 (H72)

N.B.: utilizzabili anche come ante di finitura posteriore note: one can use it also as rear finishing door

SX-DX (N.B.: anta unica per verso DX e SX)

LH-RH (note: RH and LH single door)

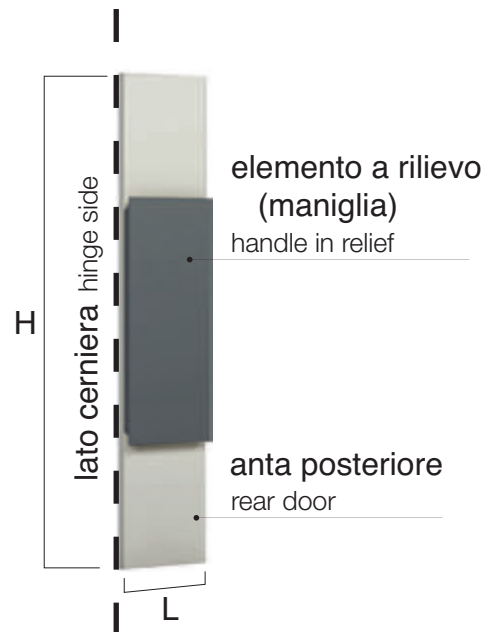

Esempio ante example doors



71,7x14,4



71,7x29,4

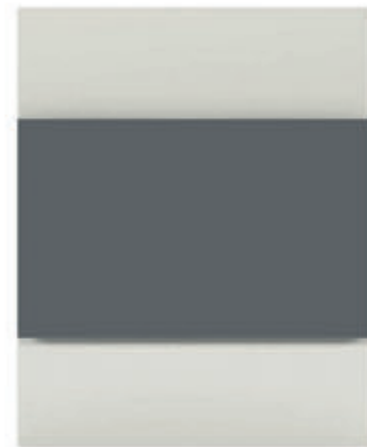

71,7x59,4
(colonna forno con lavastoviglie)
REX TTC 1003
AEG F76520VI0P

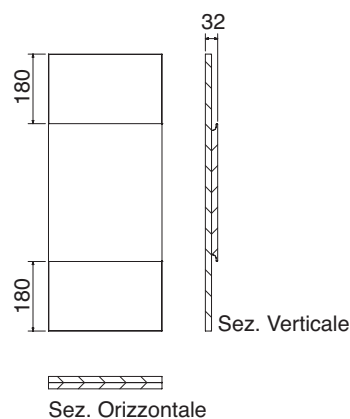

ANTE TIPO 1b (H 72) doors type 1b (H72)

N.B.: solo per basi angolo 95x95 e 110x110 note: only for 95x95 and 110x110 corner bases

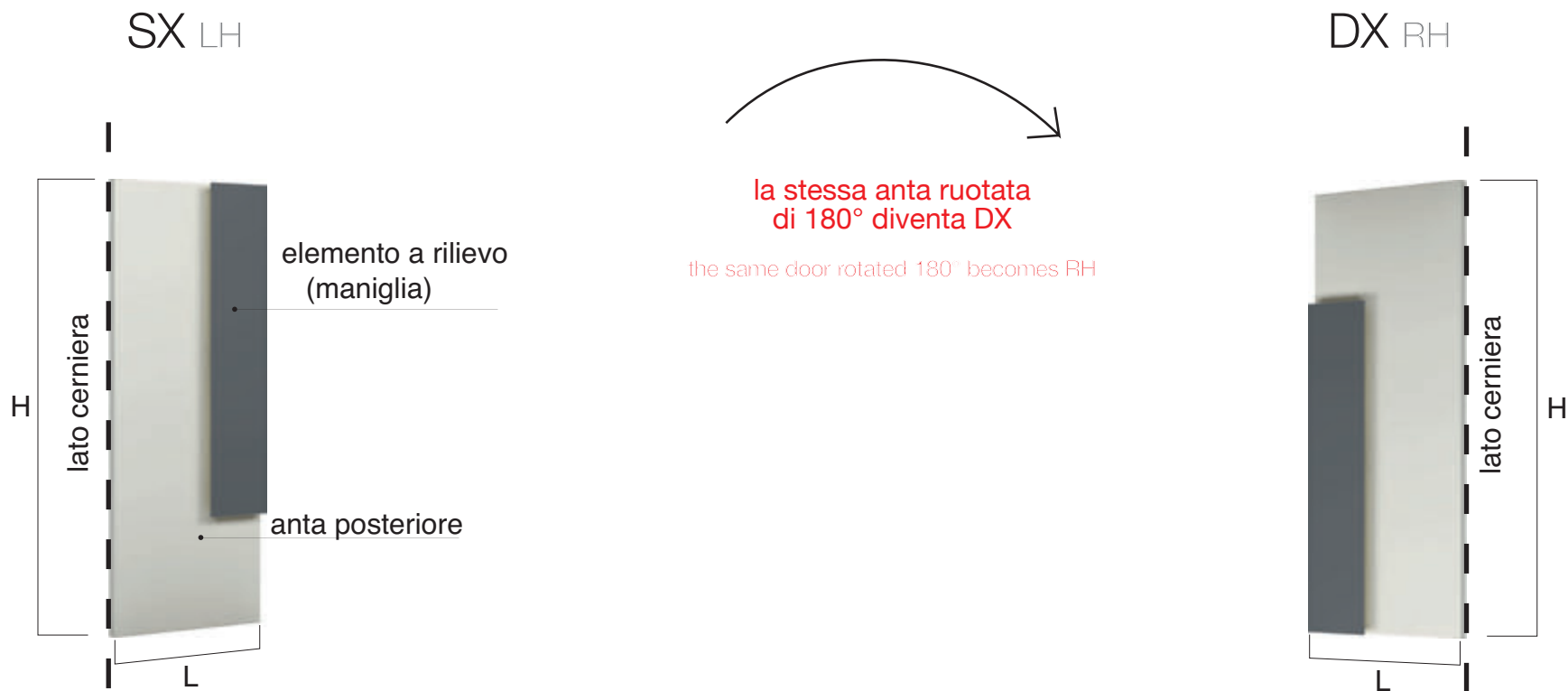

Esempio ante verso SX LH doors example



71,7x29,4

71,7x44,4

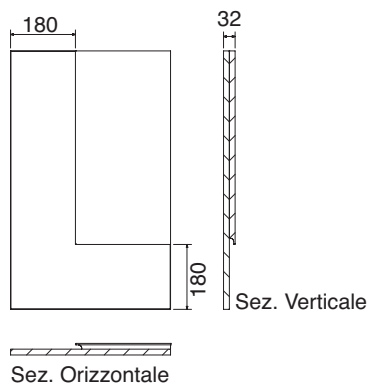

ANTE TIPO 2 (H 60 - H 72) doors type 2 (H 60 - H 72)

N.B.: utilizzabili anche come ante di finitura posteriore note: one can use it also as read finishing door

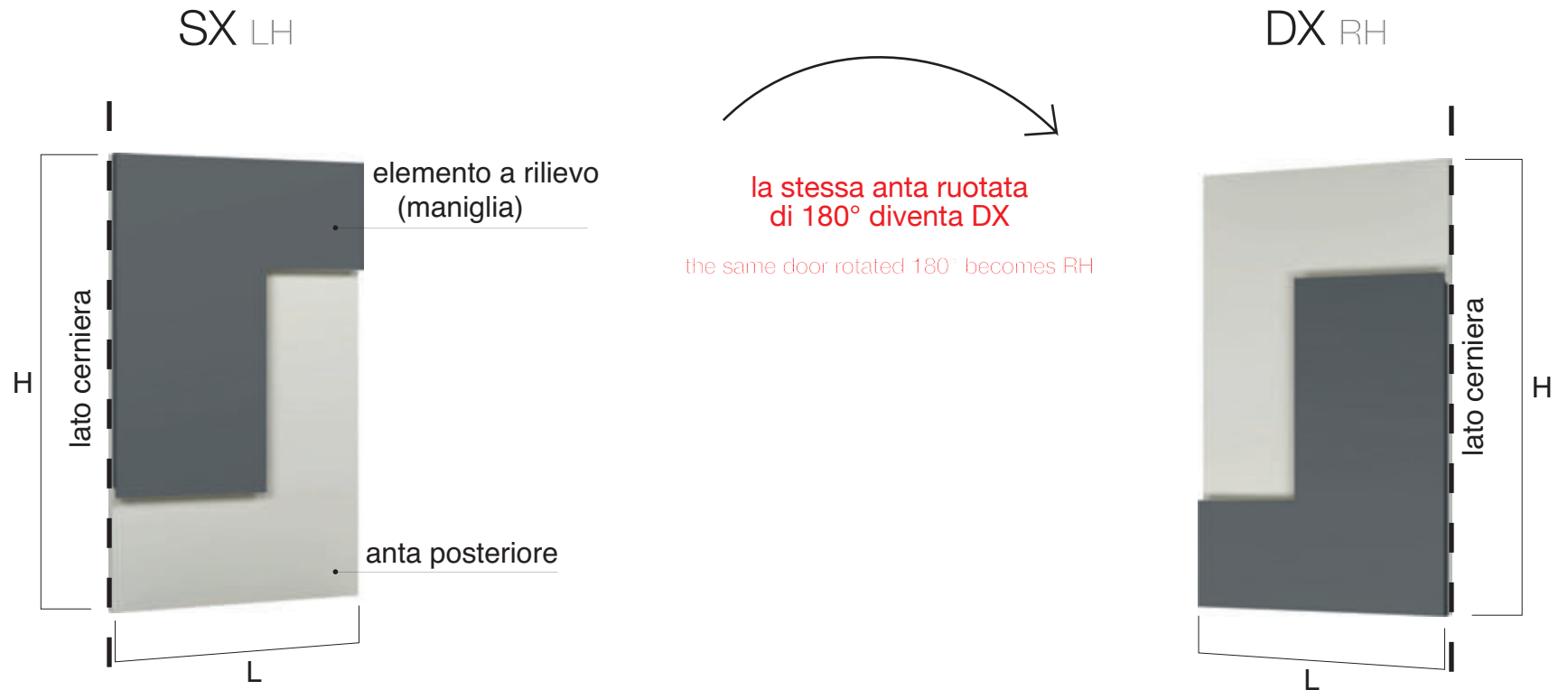

Esempio ante verso SX LH doors example



59,7x39,4
71,7x39,4



59,7x44,4
71,7x44,4



59,7x59,4
71,7x59,4



71,7x64,4

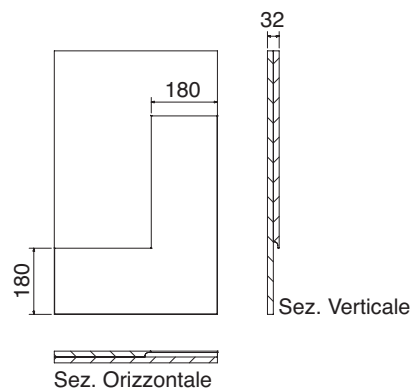

ANTE TIPO 3 (H 60 - H 72) doors type 3 (H 60 - H 72)

N.B.: utilizzabili anche come ante di finitura posteriore note: one can use it also as read finishing door

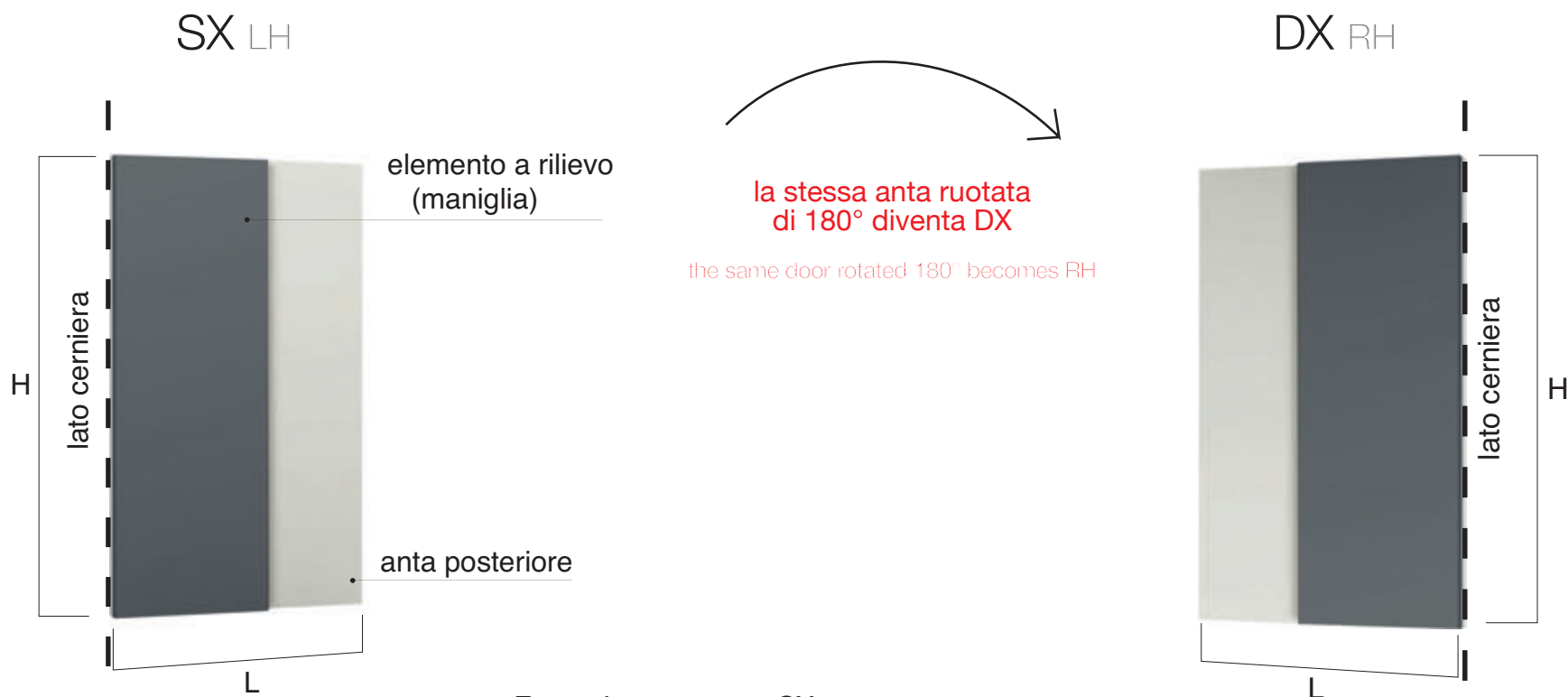

Esempio ante verso SX LH doors example



59,7x39,4
71,7x39,4



59,7x44,4
71,7x44,4



59,7x59,4
71,7x59,4

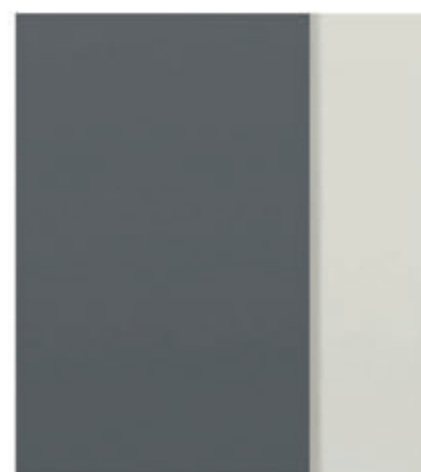

71,7x64,4

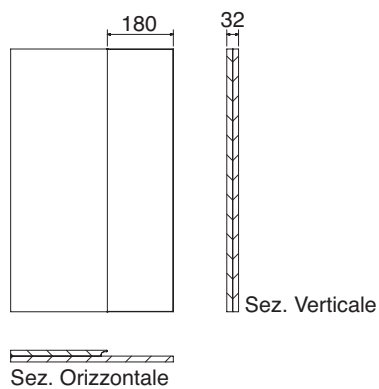

ANTE TIPO 4 (H 72) doors type 4 (H 72)

N.B.: per anta congelatore della colonna frigo note: for freezer door in fridge column

PRESA SX left opening

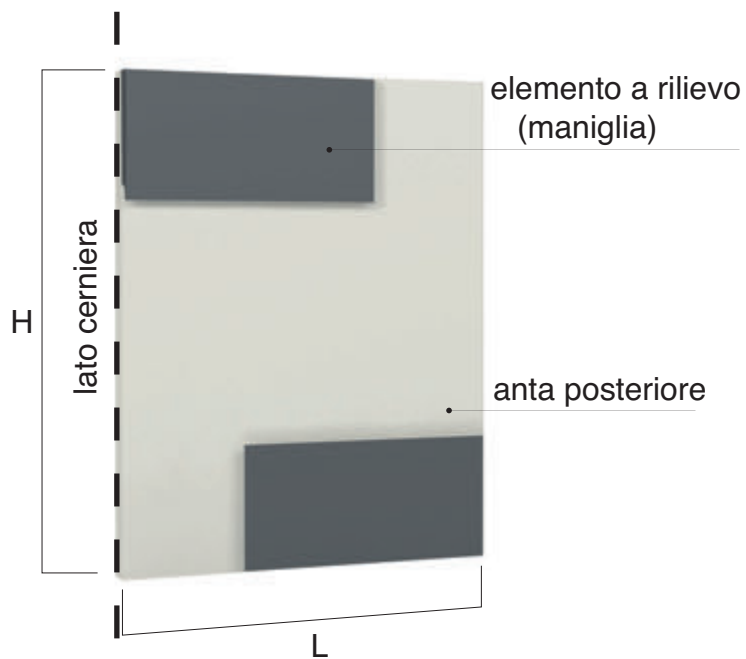

PRESA DX right opening

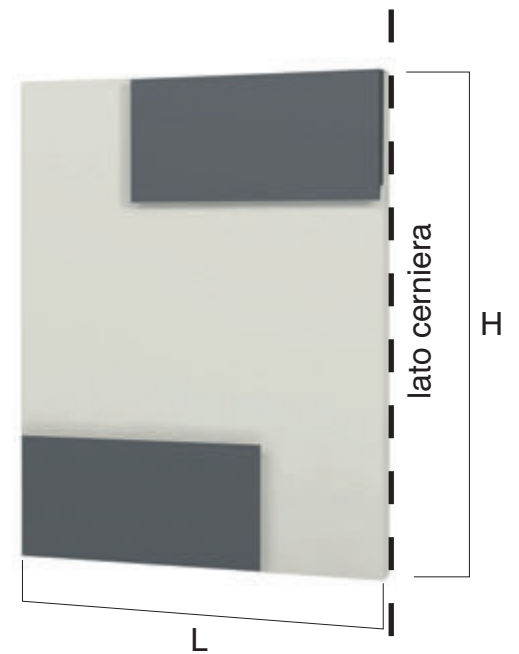

Esempio anta presa SX LH grip door example



71,7x59,4

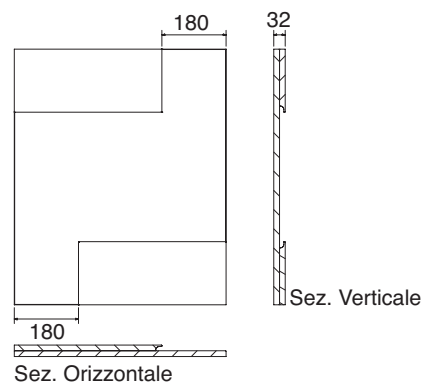

ANTE TIPO 4 (H 72) doors type 4 (H 72)

N.B.: per anta lavastoviglie note: for dishwasher door

PRESA SX left opening

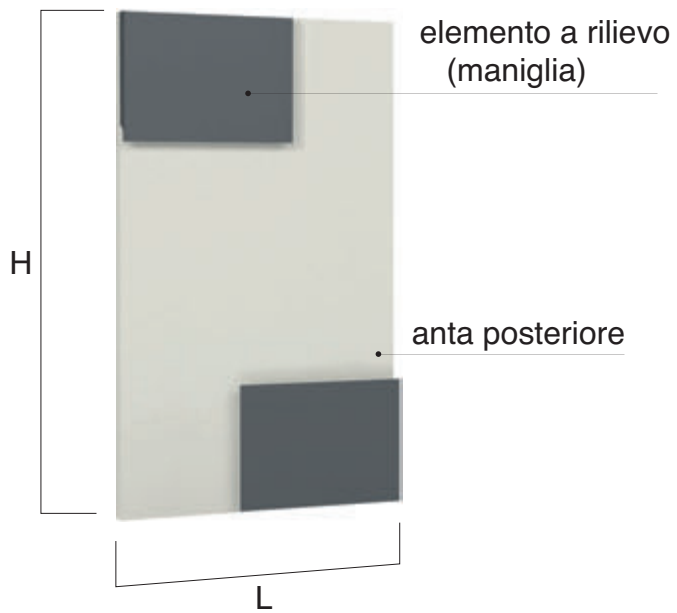

PRESA DX right opening



**nell'anta lavastoviglie
la presa DX o SX è una scelta
esclusivamente estetica**
the left or right and choice for dishwasher
door is exclusively aesthetic

Esempio ante presa SX LH grip doors example

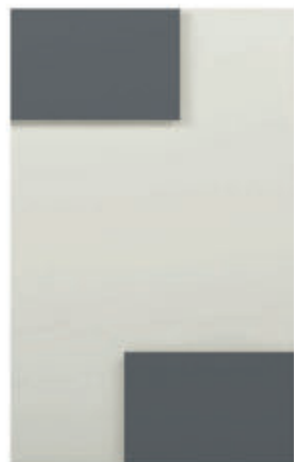

71,7x44,4

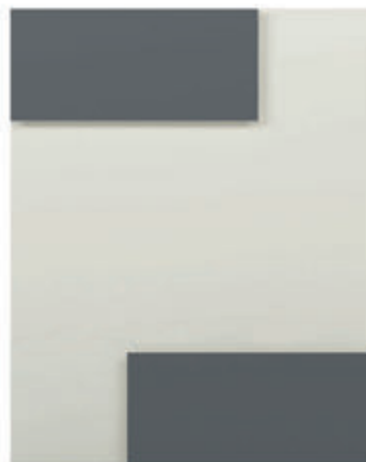

71,7x59,4

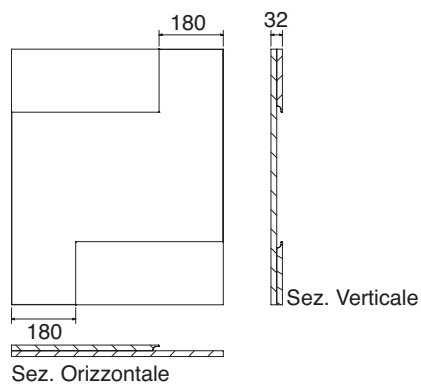

FRONTALI CASSETTI H 12-18 drawers fronts H 12-18

PRESA SX left opening

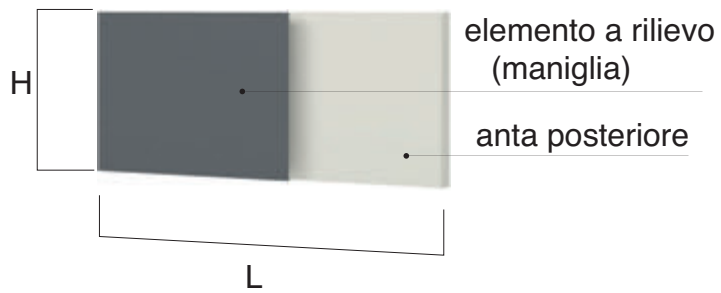

PRESA DX right opening

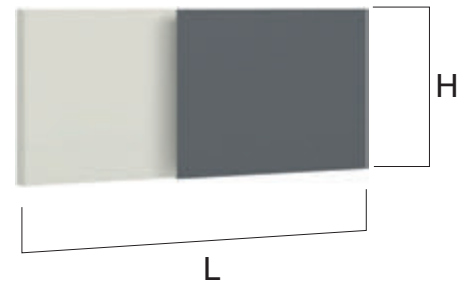

lo stesso frontale ruotato di 180° diventa con presa maniglia a DX

the same front rotated 180° turns into right opening

N.B.: la presa DX o SX è una scelta esclusivamente estetica

note: the left or right and opening is an exclusively aesthetic choice

Esempio frontali presa DX right opening example



11,7x29,4
17,7x29,4



11,7x39,4
17,7x39,4



11,7x44,4
17,7x44,4



11,7x59,4
17,7x59,4

verso unico to single



11,7x89,4
17,7x89,4



11,7x119,4
17,7x119,4

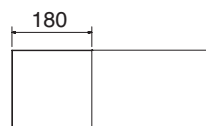

Sez. Orizzontale

32



Sez. Verticale

FRONTALI CASSETTI H 24 drawers fronts H 24

PRESA SOPRA top grip

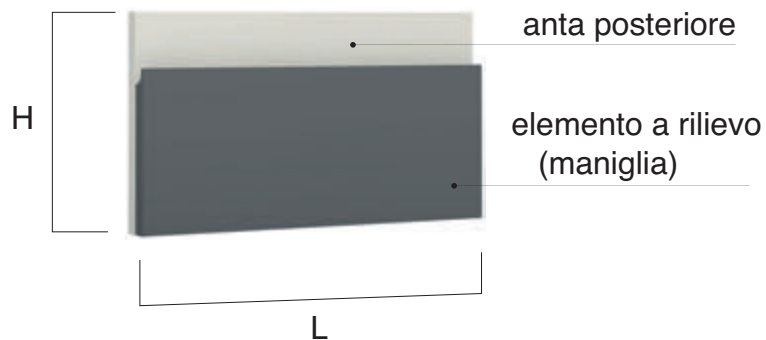

lo stesso frontale ruotato di 180° diventa con presa sotto
the same front rotated 180° turns into grip on bottom opening

N.B.: la presa SOPRA o SOTTO è una scelta esclusivamente estetica

note: the left or right and opening is an exclusively aesthetic choice

PRESA SOTTO grip on bottom

grip on bottom

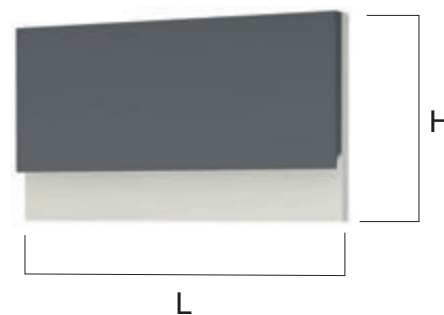

Esempio ante presa SOPRA top grip opening example



23,7x44,4



23,7x59,4



23,7x89,4



23,7x119,4

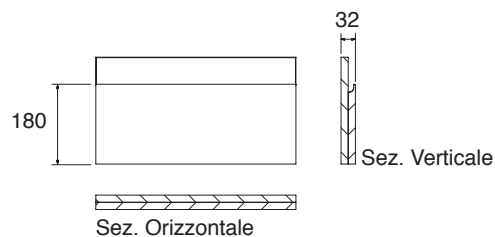

FRONTALI CESTONI H 36 deep drawers fronts H 36

PRESA SX left opening

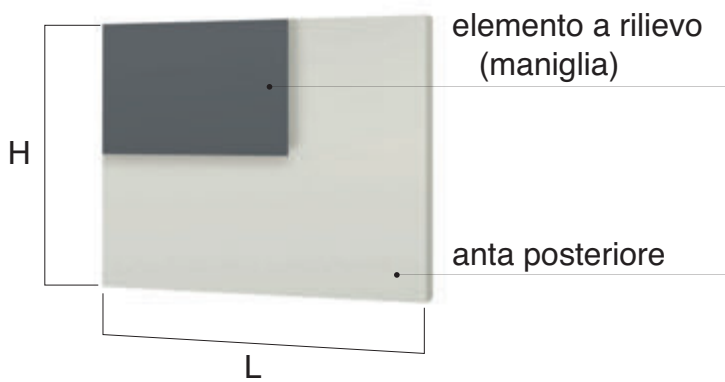

lo stesso frontale ruotato di 180° diventa con presa DX

the same front rotated 180° turns into right opening

N.B.: la presa DX o SX è una scelta esclusivamente estetica

note: the left or right opening is an exclusively aesthetic choice

PRESA DX right opening

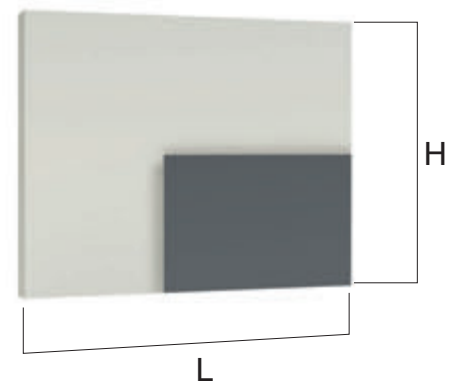

Esempio ante presa DX RH grip doors example



35,7x44,4



35,7x59,4



35,7x89,4



35,7x119,4

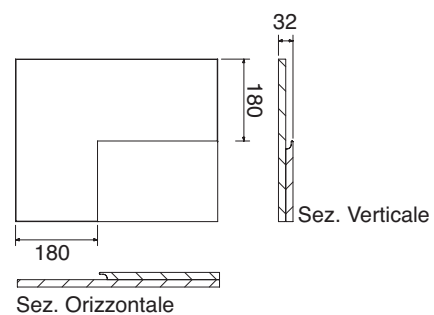

FRONTALI CESTONI H 48 deep drawers fronts H 48

PRESA SOPRA top grip

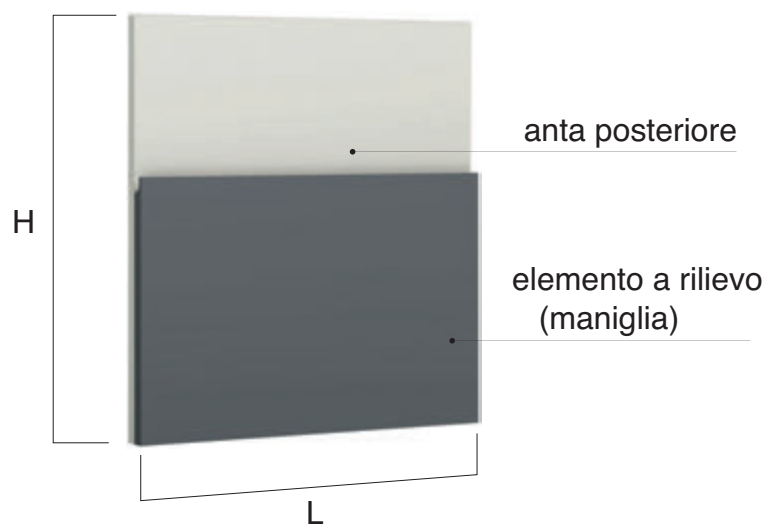

PRESA SOTTO grip on bottom

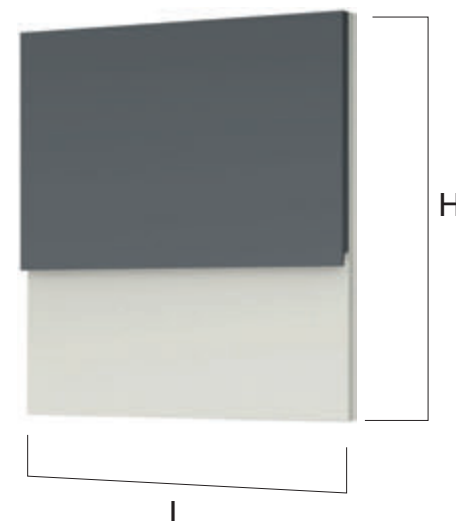

lo stesso frontale ruotato di 180° diventa con presa sotto

the same front rotated 180° turns into grip on bottom opening

N.B.: la presa SOPRA o SOTTO è una scelta esclusivamente estetica

note: the left or right and opening is an exclusively aesthetic choice

Esempio ante presa SOPRA top grip opening example



47,7x44,4



47,7x59,4



47,7x89,4



47,7x119,4

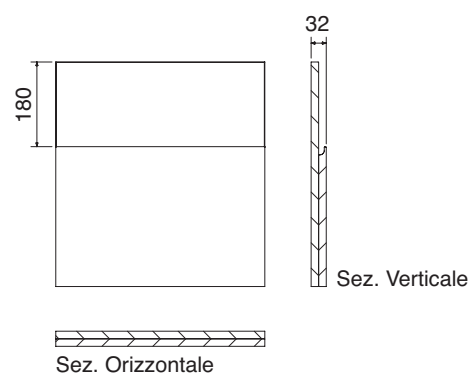

ANTE UNICHE CESTONI TIPO 4 (H 60-H 72) single deep drawers fronts type 4 (H 60-H 72)

N.B.: utilizzabili anche come ante di finitura posteriore note: one can use it also as rear finishing door

PRESA SX left opening

PRESA DX right opening

N.B.: il verso della presa è una scelta esclusivamente estetica

note: the left or right and opening is an exclusively aesthetic choice

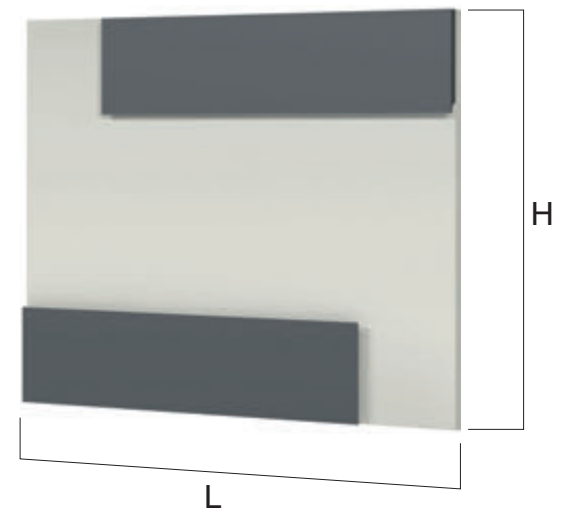
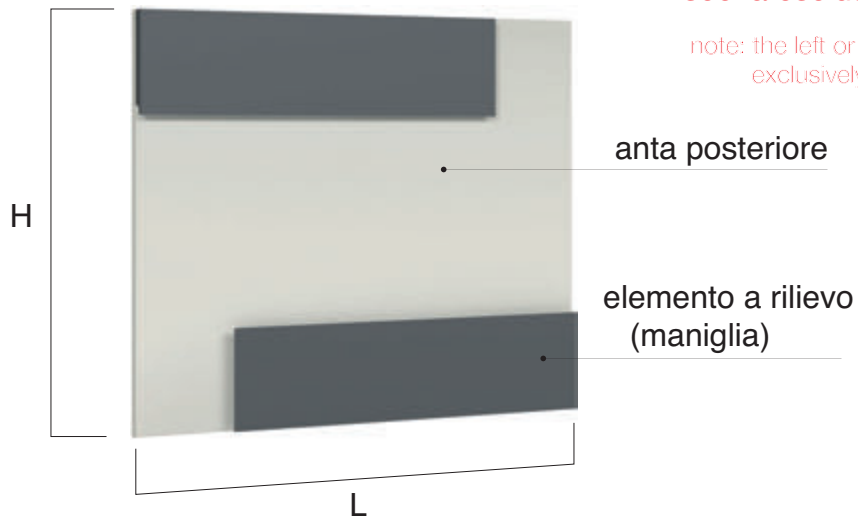

Esempio ante presa SX LH grip doors example



59,7x44,4
71,7x44,4

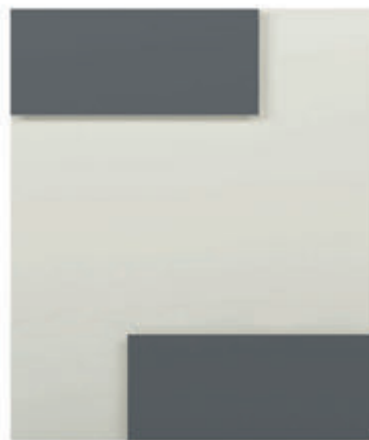

59,7x59,4
71,7x59,4

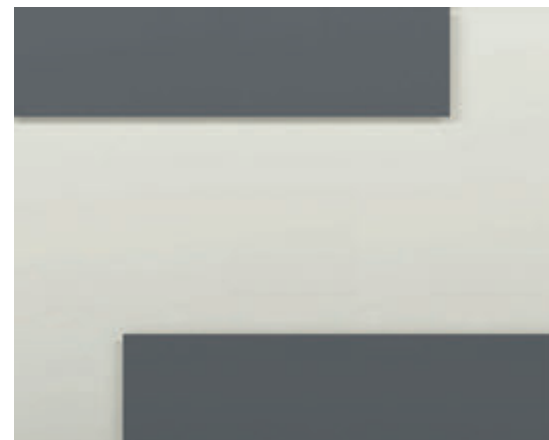

59,7x89,4
71,7x89,4

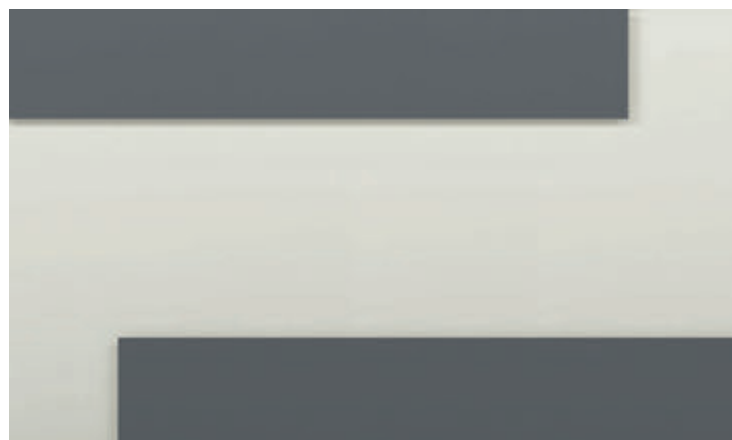

59,7x119,4
71,7x119,4

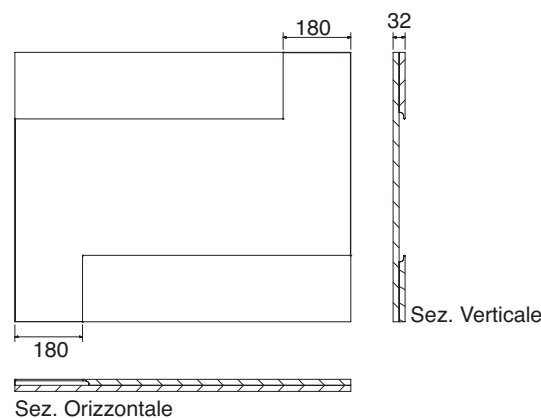

ANTE COLONNE TIPO 1c (H 96-H 132) columns doors type 1c (H 96-H 132)

SX-DX (N.B.: anta unica per verso DX e SX)

LH-RH (note: RH and LH single door)

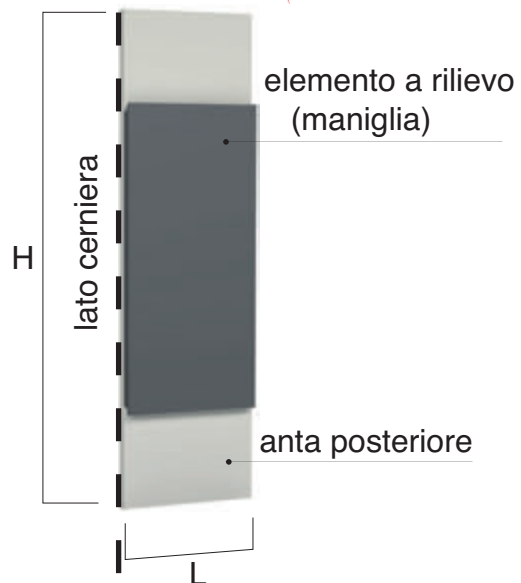

95,7x29,4
131,7x29,4

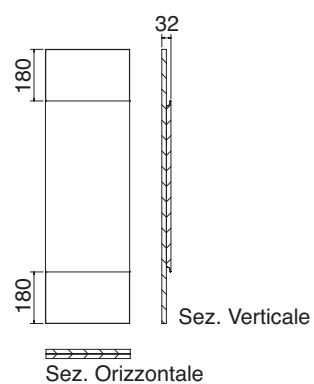

ANTE COLONNE TIPO 2c (H 96) columns doors type 2c (H 96)

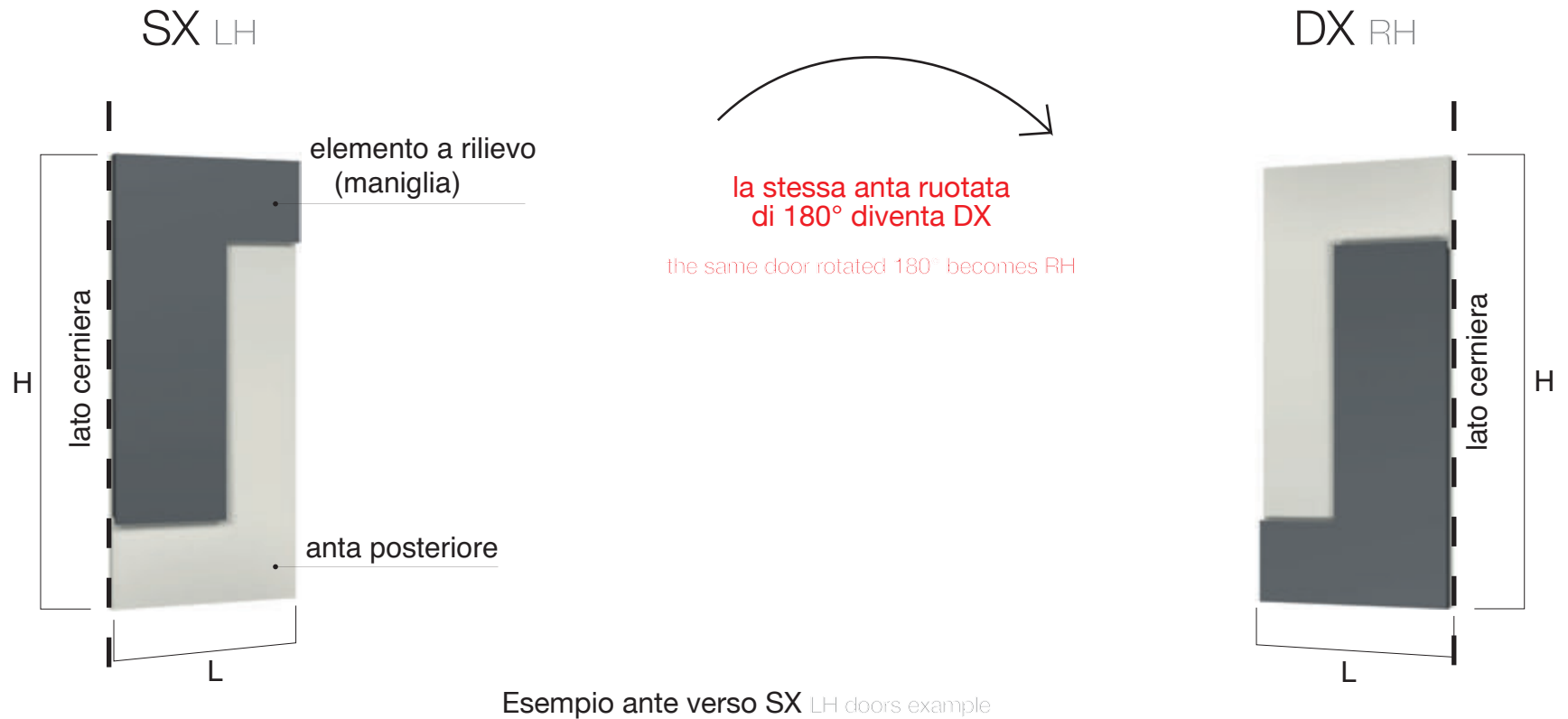

95,7x39,4

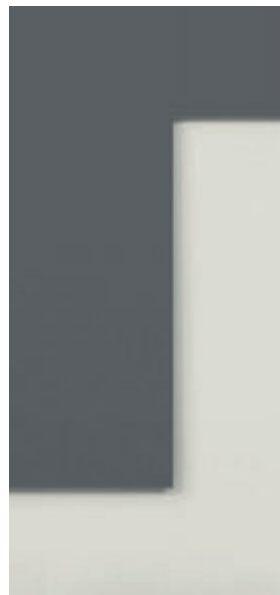

95,7x44,4

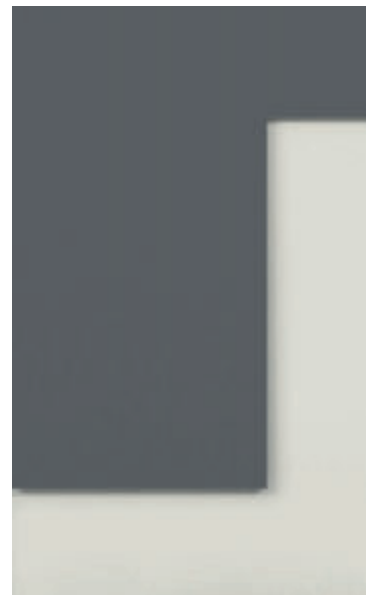

95,7x59,4

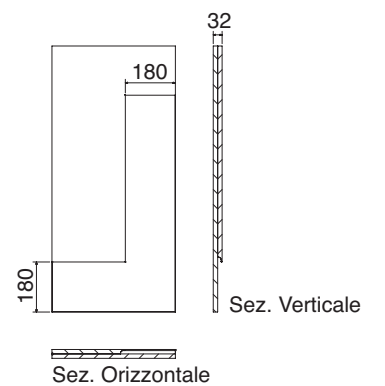

ANTE COLONNE TIPO 3c (H 84 - H 96) columns doors type 3c (H 84-H 96)

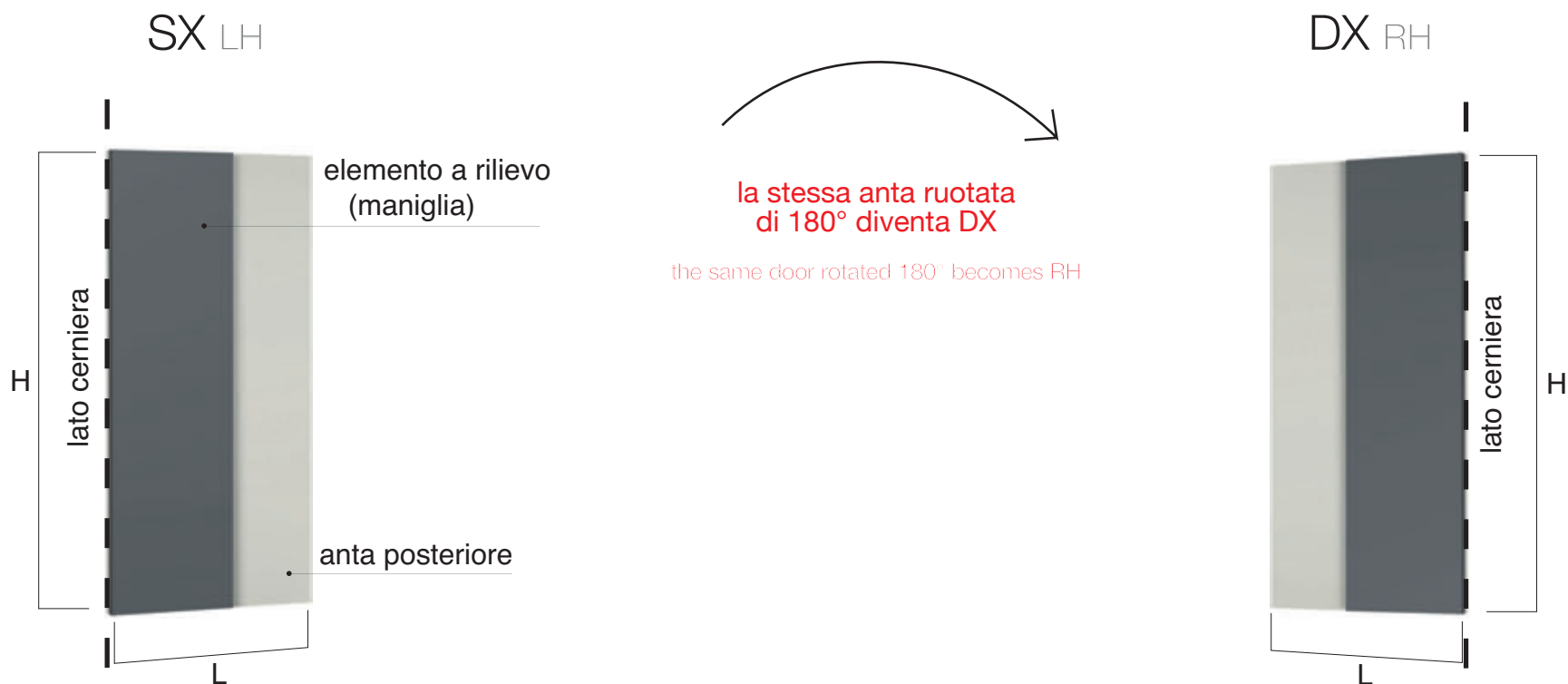

Esempio ante verso SX LH doors example

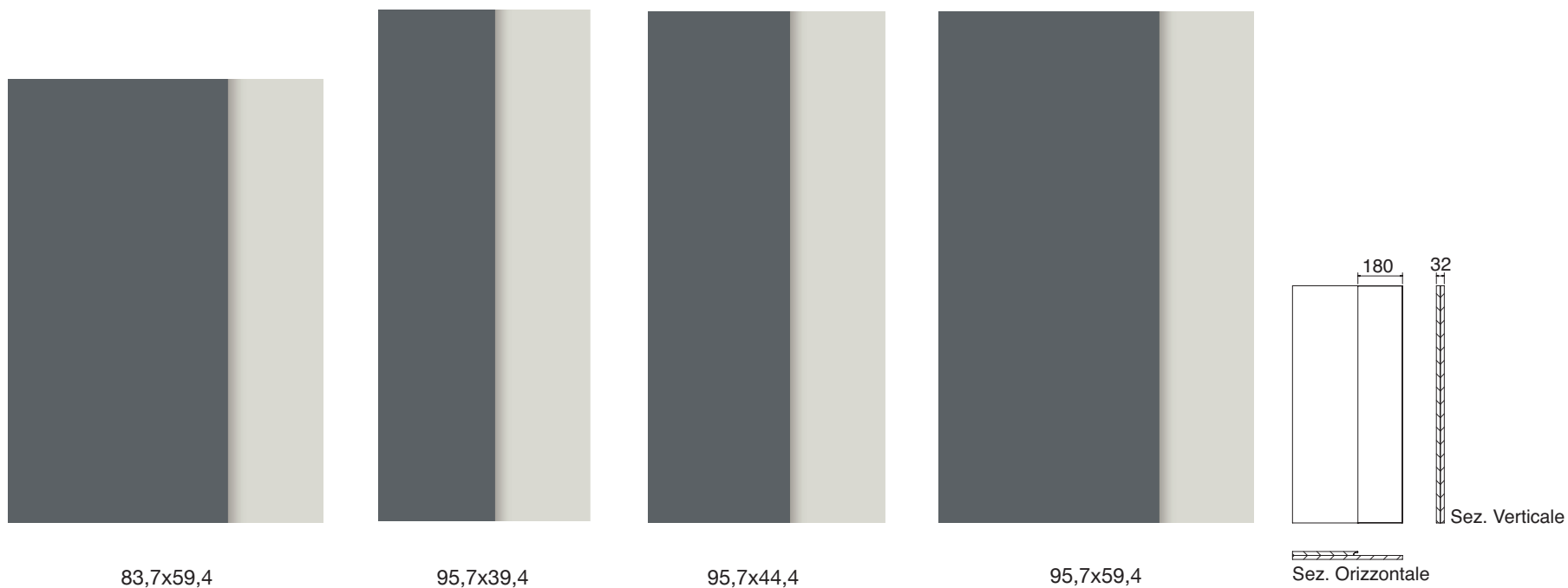

ANTE COLONNE TIPO 3c (H 108-H 120-H 132)

columns doors type 3c (H 108-H 120-H 132)

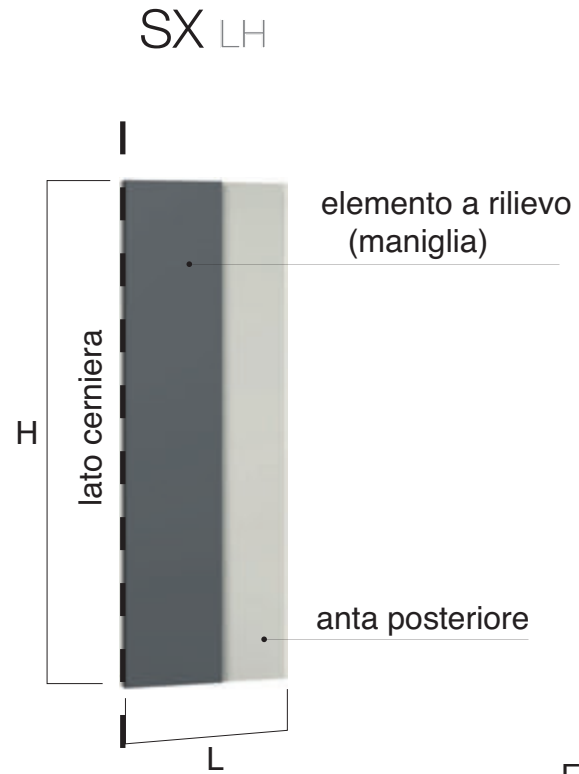

la stessa anta ruotata di 180° diventa DX

the same door rotated 180° becomes RH

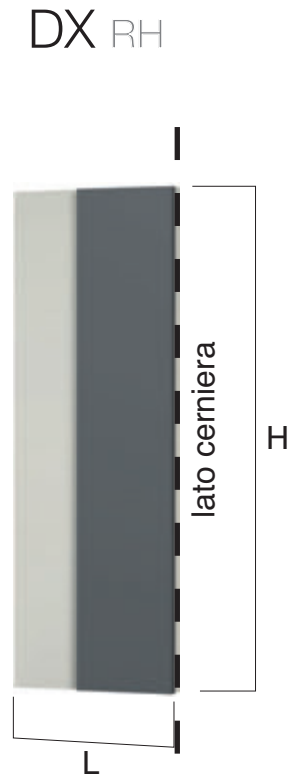

Esempio ante verso SX LH doors example

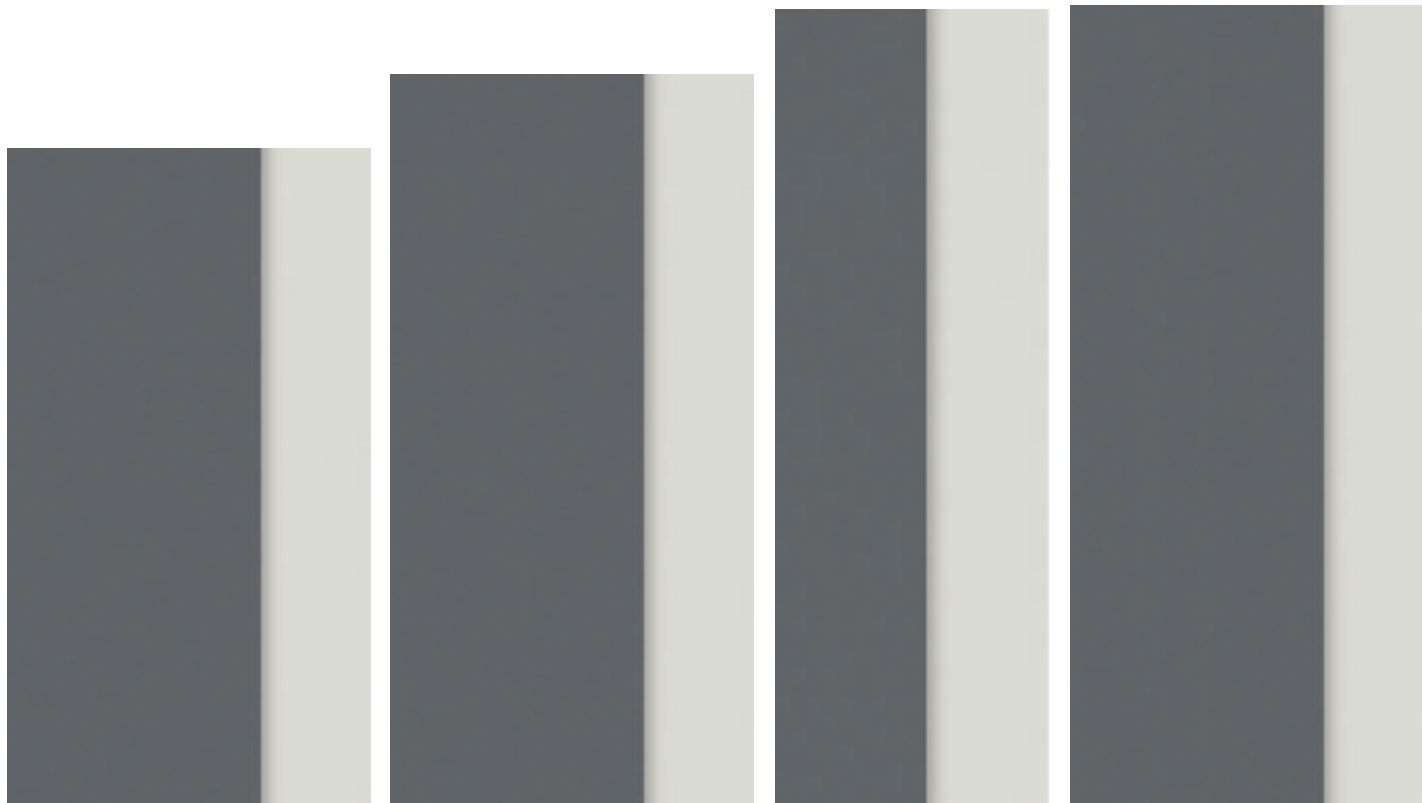

107,7x59,4

119,7x59,4

131,7x44,4

131,7x59,4

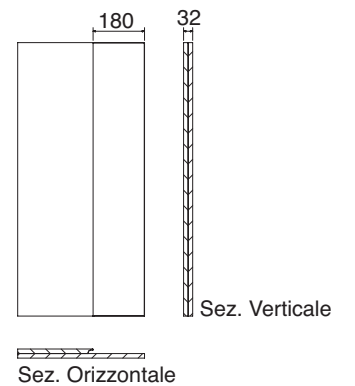

ANTE COLONNE TIPO 3c (H 156 - H 180) columns doors type 3c (H 156-H 180)

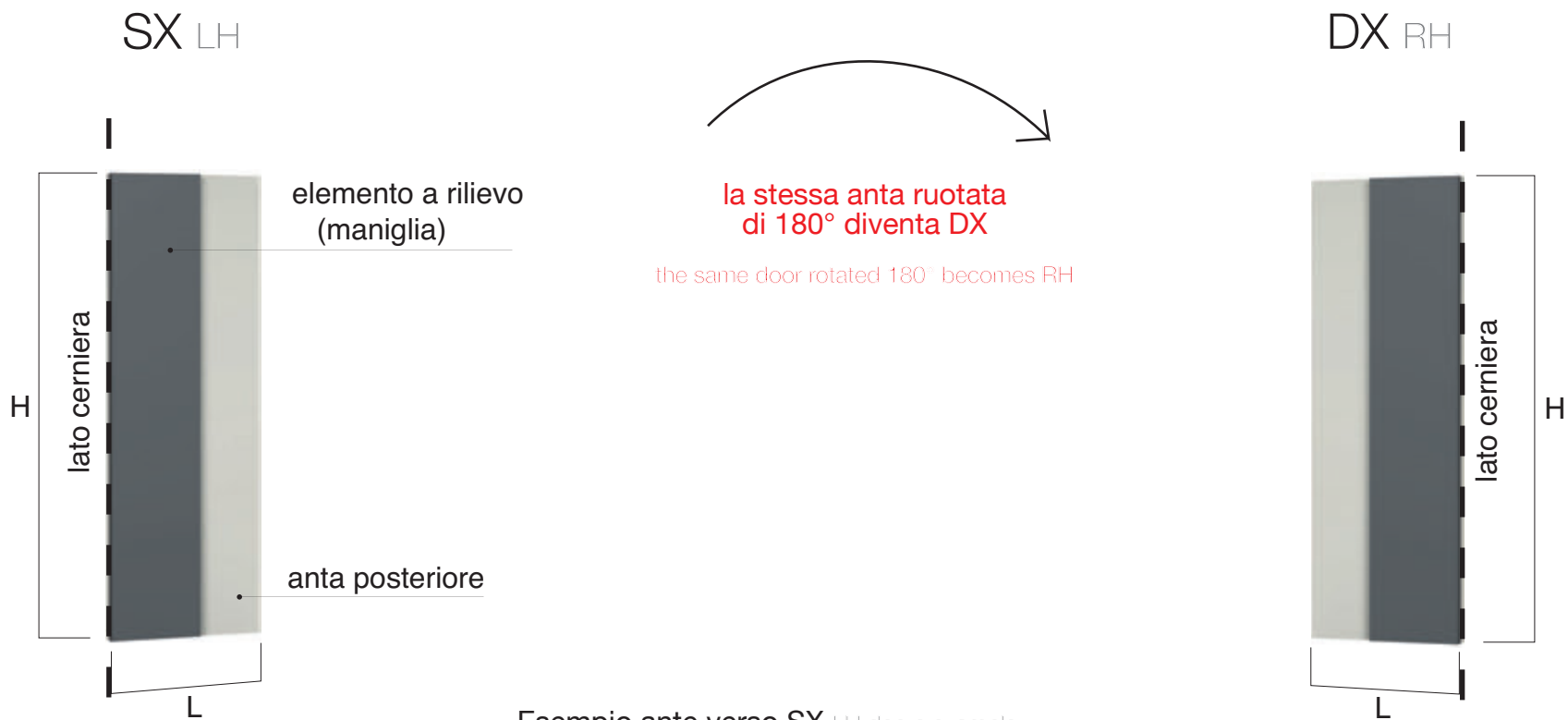

Esempio ante verso SX LH doors example

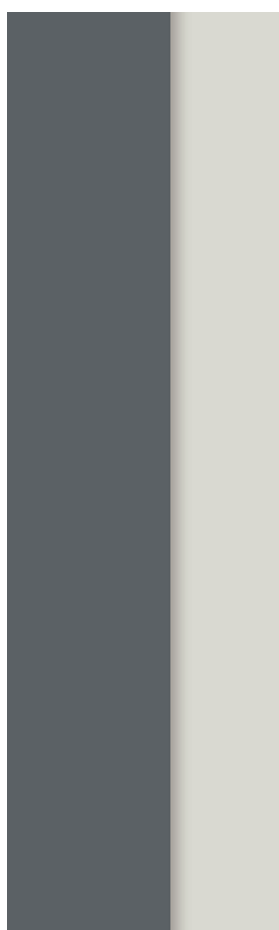

155,7x44,4

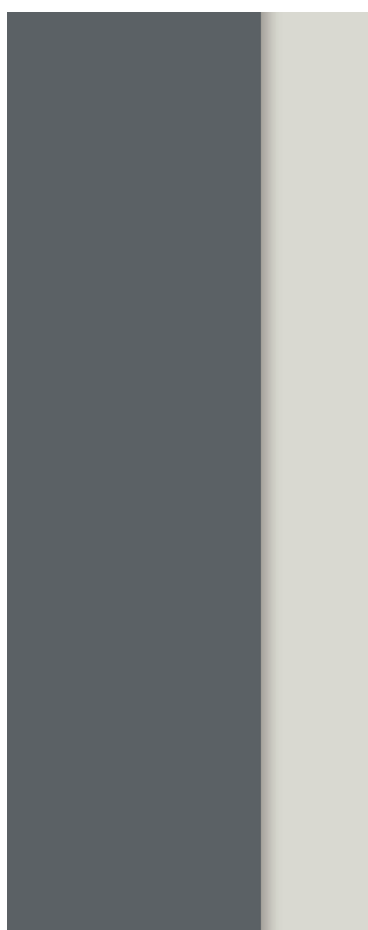

155,7x59,4

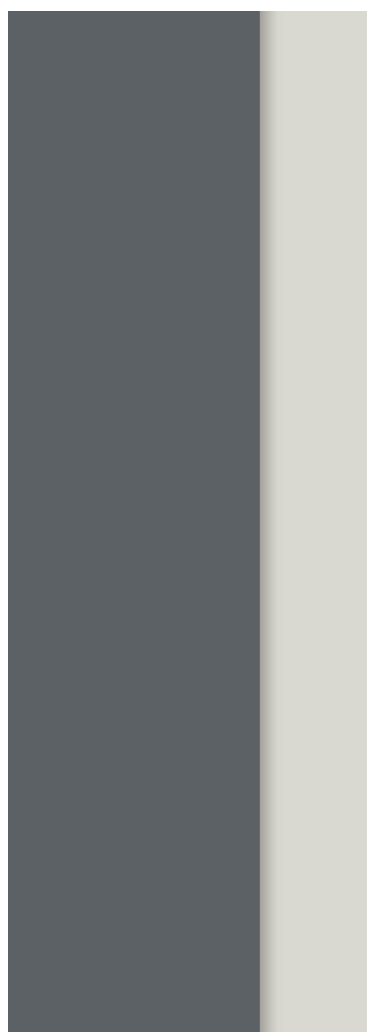

179,7x59,4

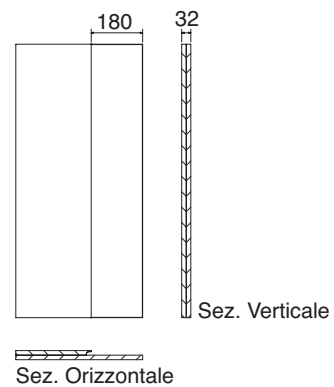

ANTE COLONNE TIPO 5c (H 204) columns doors type 5c (H 204)

N.B.: anta monoporta note: single door

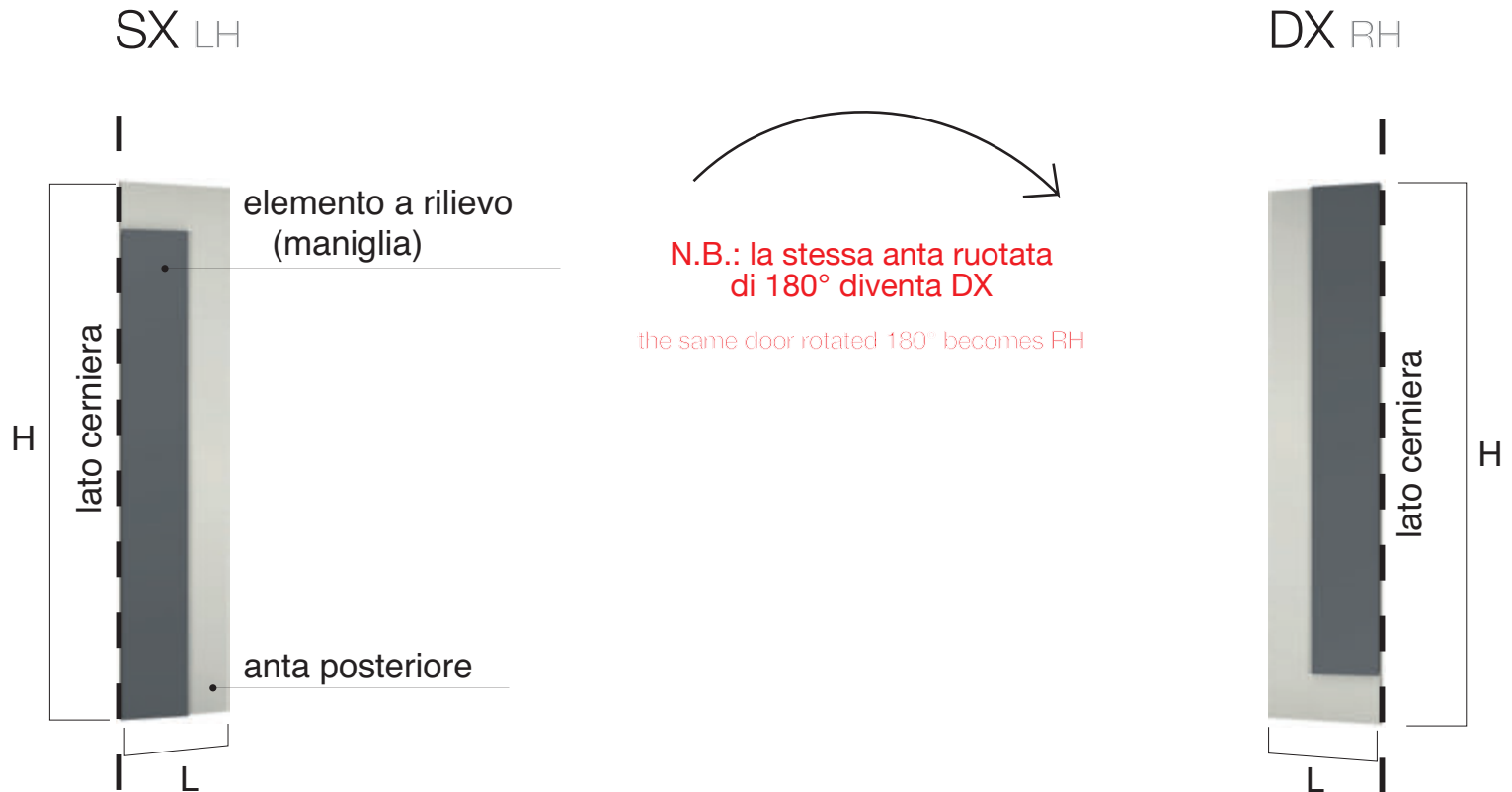

Esempio ante verso SX LH doors example

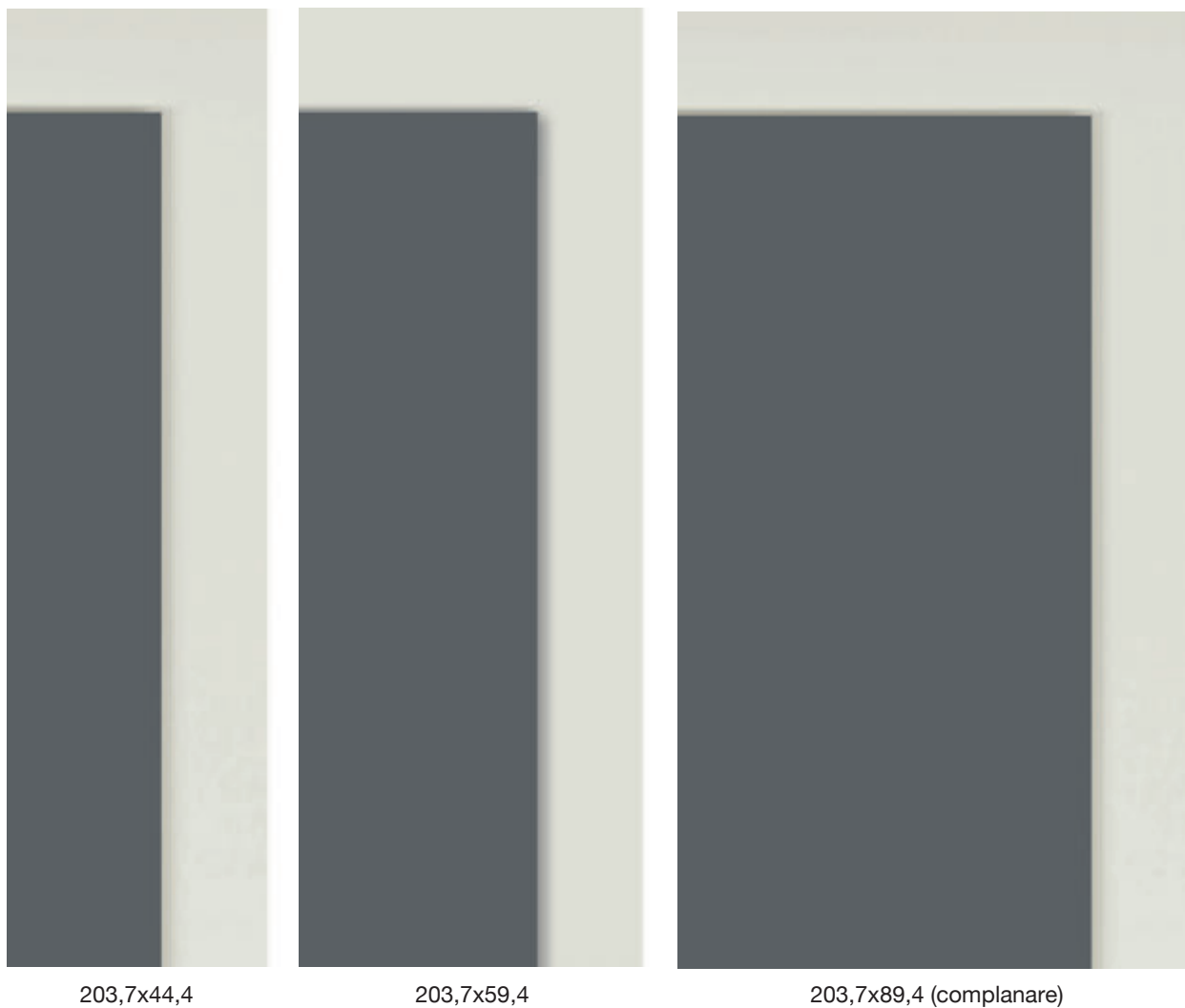

ANTE COLONNE TIPO 6c (H 204)

columns doors type 6c (H 204)

N.B.: solo per colonna con cestello estraibile

note: only for column with pull out basket

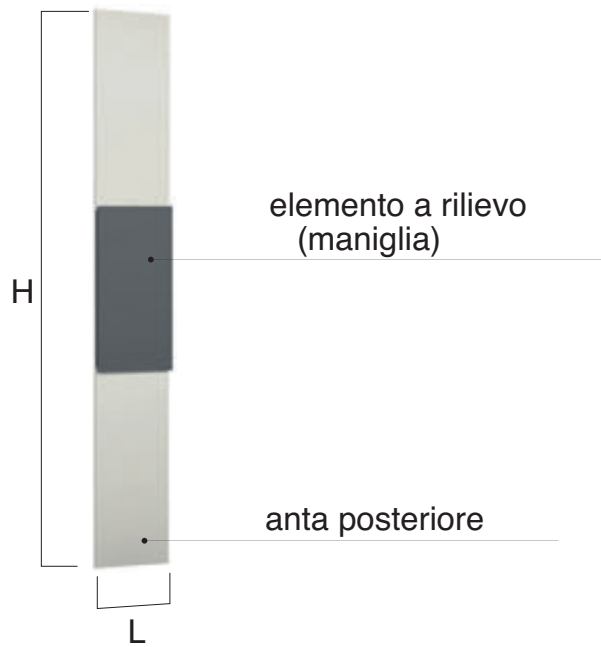

ANTE COLONNE TIPO 7c (H 204)

columns doors type 7c (H 204)

N.B.: solo per colonna angolo 105x105

note: only 105x105 corner column

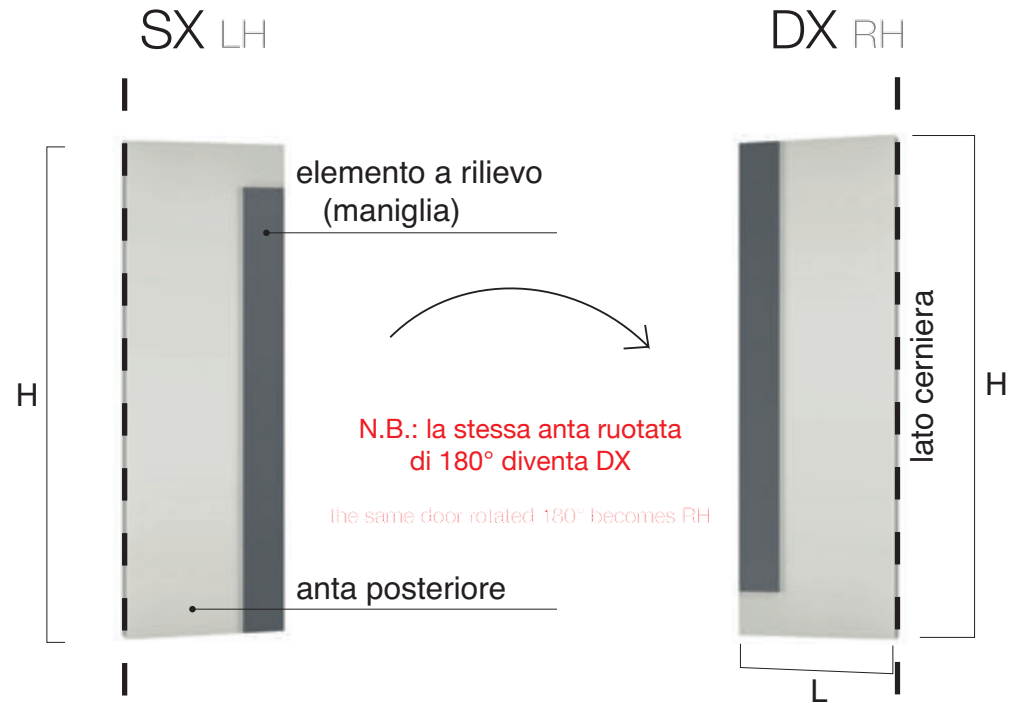

Esempio anta verso DX RH door example

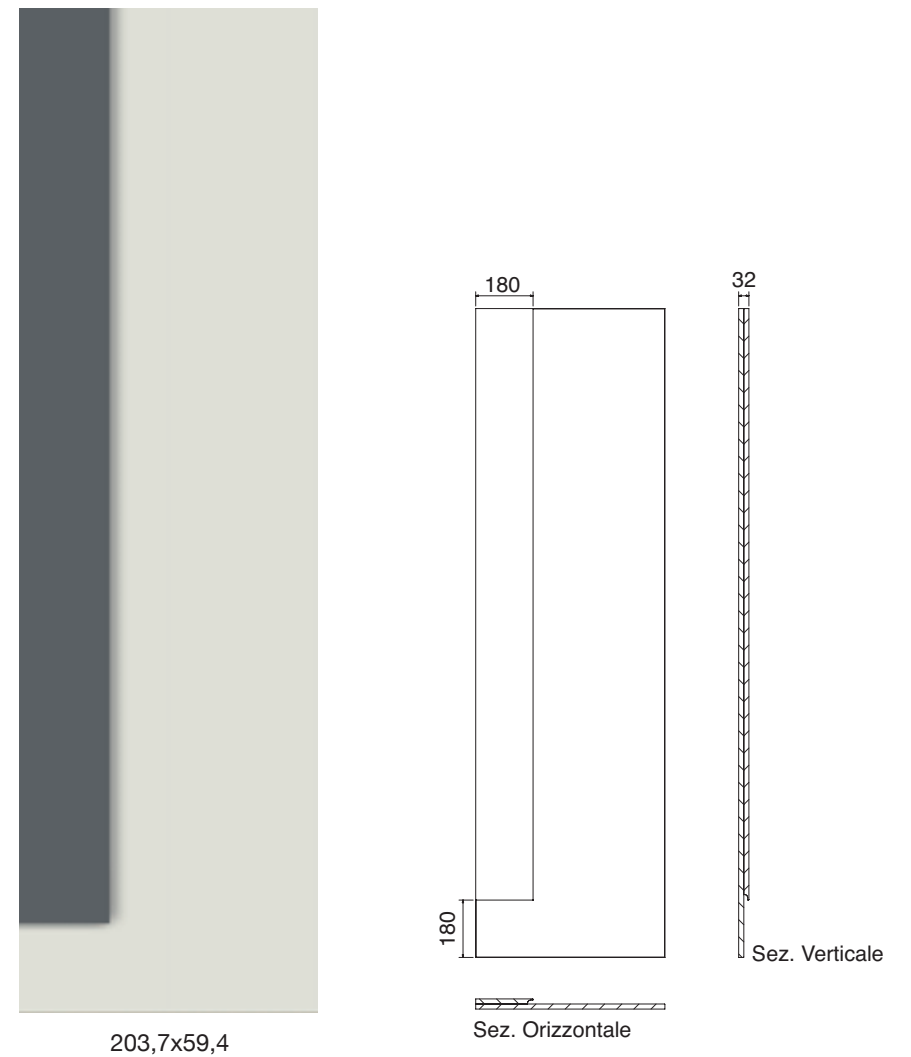
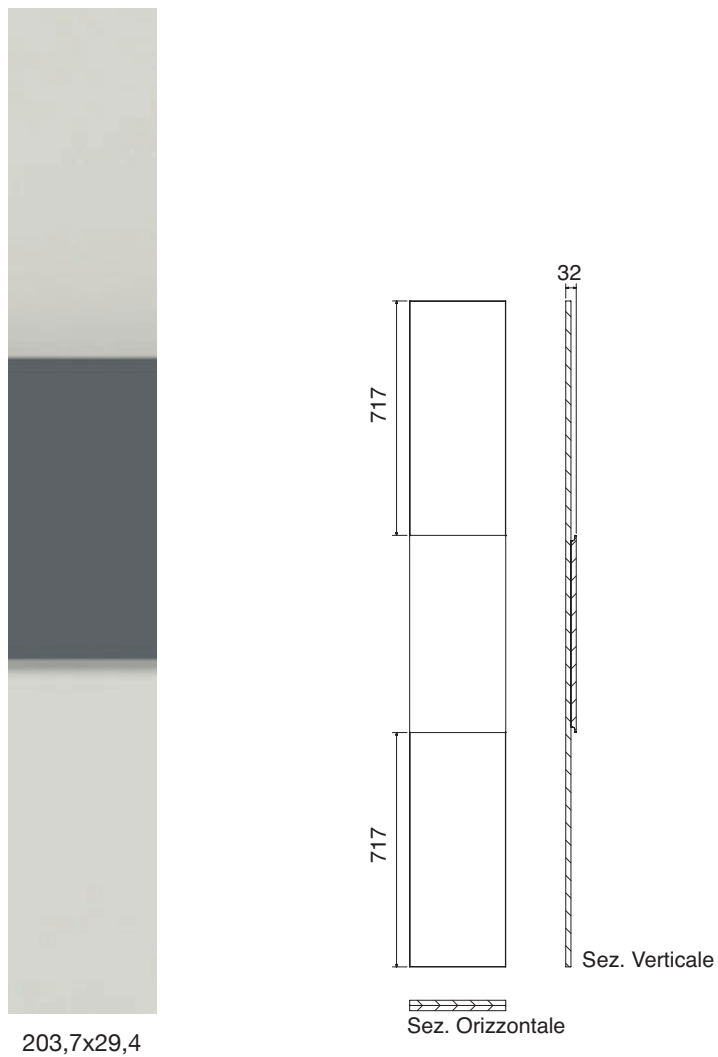



Buy on
MARKET
CONTEMPORARY DESIGN

