

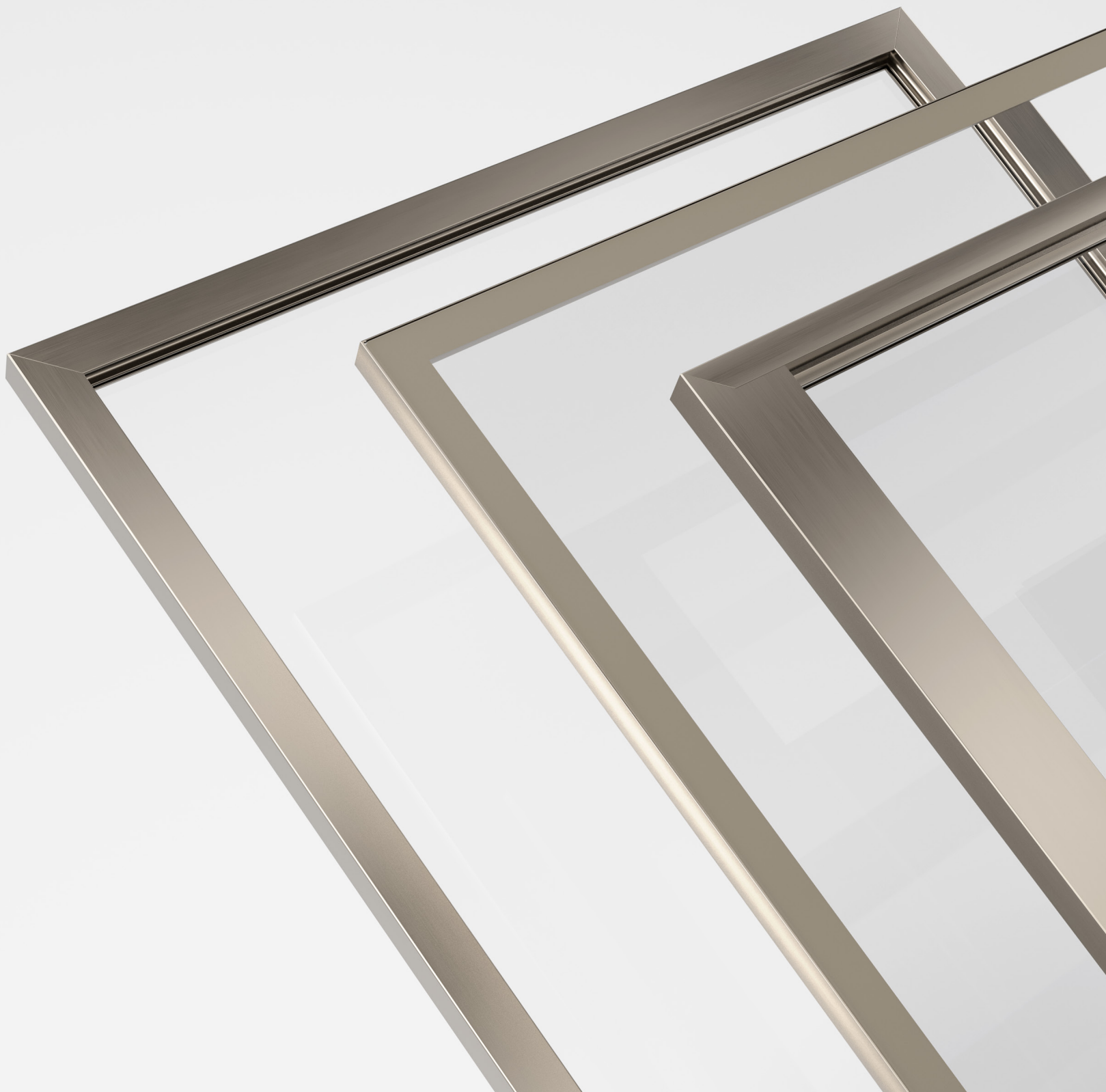

2025

crystal frame

CRYSTAL Frame



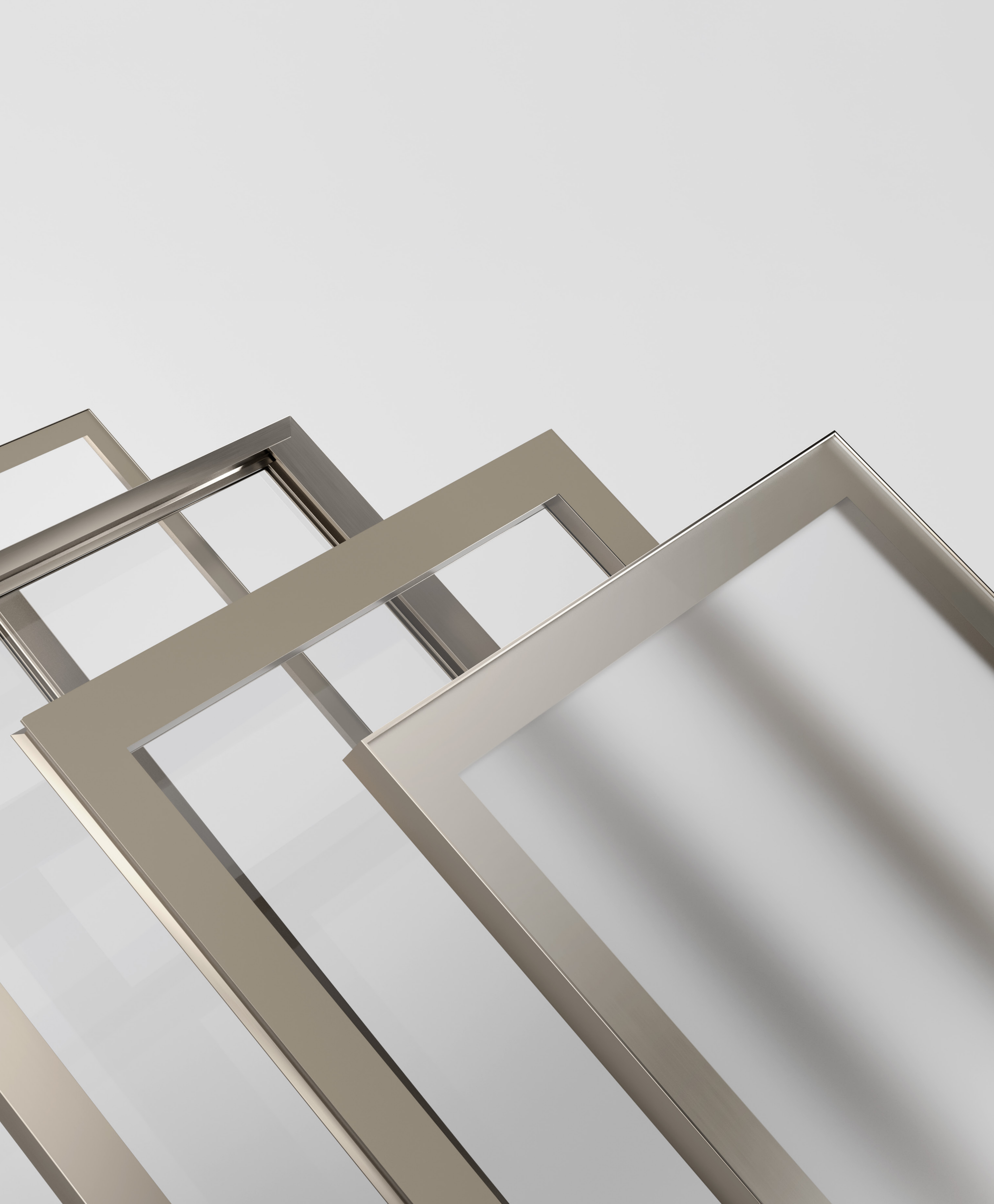

CRYSTAL Frame

// Versatile e Trasversale

IL NUOVO SISTEMA DI ANTE TELAIO ALLUMINIO E VETRO UNIVERSALE **PER TUTTI I MODELLI LUBE**

CRYSTAL Frame è il sistema di ante vetro universale progettato per abbinarsi a tutti i modelli LUBE, offrendo così un'elevata versatilità compositiva.

Con **CRYSTAL Frame**, è possibile scegliere tra **diverse tipologie di telaio e vetri, con più finiture**, offrendo opzioni di **apertura con gola o con maniglia**, per soddisfare ogni esigenza estetica e funzionale.

Le ante "**Quadra**" e "**Silk**", con cerniera a scomparsa, permettono continuità estetica con gli elementi a giorno e i sistemi a spalla consentendo la creazione di ambienti cucina e living coordinati e armoniosi.

CRYSTAL Frame: THE NEW GLASS AND ALUMINUM FRAME DOOR SYSTEM UNIVERSAL
// Versatile and Transversal FOR ALL LUBE MODELS

CRYSTAL Frame is the universal glass door system designed to match all CREO models, offering high compositional versatility.

With CRYSTAL Frame, it is possible to choose from different types of frames and glasses, with multiple finishes, offering opening options with finger rail or handle, to meet every aesthetic and functional need.

The 'Quadra' and 'Silk' doors, with hidden hinges, allow for aesthetic continuity with the open units and the bookcase with load-bearing side panel systems, enabling the creation of coordinated and harmonious kitchen and living spaces.



QUADRA

SILK

LUMINA

REFLECTA

VISION

CRYSTAL Frame

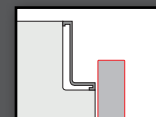

Neck

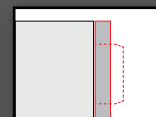

Bridge



anta "QUADRA" e anta "SILK" disponibili anche per

"QUADRA" and "SILK" doors also available for

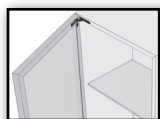

ELEMENTI A GIORNO CON ANTA
OPEN UNITS WITH DOOR

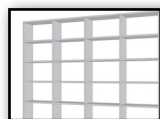

LIBRERIA A SPALLA
BOOKCASE WITH LOAD BEARING SIDE PANELS

i Le ante "QUADRA" e "SILK" permettono continuità estetica in tutti quegli ambienti dove sono presenti cucina, elementi a giorno e libreria a spalla, essendo disponibili nei tre sistemi, sempre con cerniera a scomparsa e con una vasta gamma di finiture.

"QUADRA" and "SILK" doors allows aesthetic continuity in kitchen, open units and bookcase with load bearing side panels, being available in the three systems, always with hidden hinge and with a wide range of finishes.

SP: 22
TH: MM

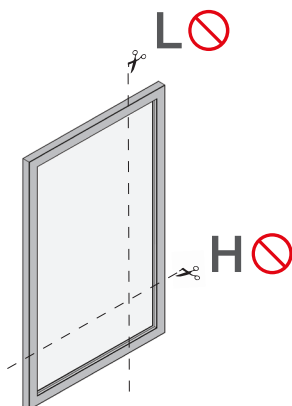
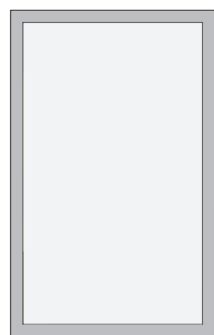

TELAIO
FRAME

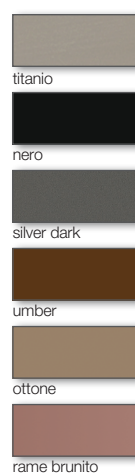

VETRO
GLASS



anta "QUADRA"
"QUADRA" door

i anta con presa maniglia perimetrale su telaio. Push-Pull e presa sul fondo non realizzabili.
anta con cerniera "Air" a scomparsa.
door with perimeter handle grip on frame. Push-Pull not possible. Door with hidden 'Air' hinge.

SP: 22
TH: MM

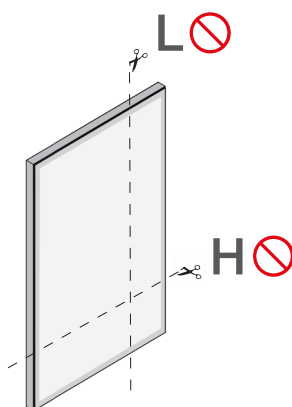
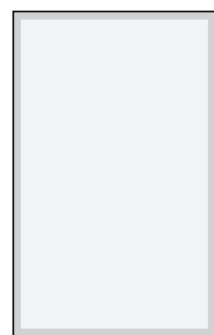

TELAIO
FRAME

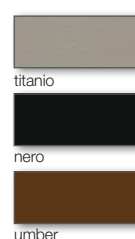

VETRO
GLASS

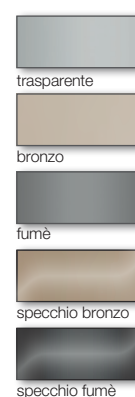

anta "SILK"
"SILK" door

i anta disponibile con maniglia integrata e con gola senza maniglia. Push-Pull e presa sul fondo non realizzabili.
anta con cerniera "Air" a scomparsa.
door available with integrated handle, bottom grip and finger rail without handle. Push-Pull not possible. Door with hidden 'Air' hinge.

**CRYSTAL FRAME È ABBINABILE
CON L'INTERA COLLEZIONE**
CRYSTAL FRAME IS MATCHABLE WITH
THE ENTIRE MODELS COLLECTION



SP: **22** MM
TH: **22** MM

TELAIO FRAME

- titanio
- nero
- silver dark
- umber
- ottone
- rame brunito

VETRO GLASS

- trasparente
- bronzo
- fumè
- cannettato satinato bianco
- cannettato satinato bronzo
- cannettato satinato fumè
- cannettato satinato rame brunito

anta **"LUMINA"**
"LUMINA" door

i anta con presa maniglia perimetrale su telaio, disponibile anche Push-Pull, con presa sul fondo e con gola.
door with perimeter handle grip on frame, also available Push-Pull, with bottom grip and with finger rail.

SP: **22** MM
TH: **22** MM

TELAIO FRAME

- titanio
- nero
- umber

VETRO GLASS

- trasparente
- bronzo
- fumè

anta **"REFLECTA"**
"REFLECTA" door

i anta con presa maniglia perimetrale su telaio, disponibile anche Push-Pull, con presa sul fondo e con gola.
door with perimeter handle grip on frame, also available Push-Pull, with bottom grip and with finger rail.

SP: **22** MM
TH: **22** MM

TELAIO FRAME

- titanio
- nero
- silver dark

VETRO GLASS

- satinato
- bronzo
- fumè

anta **"VISION"**
"VISION" door

i anta senza presa maniglia, disponibile Push-Pull, con presa sul fondo e con gola.
door without handle grip, available Push-Pull, with bottom grip and with finger rail.



MADE IN ITALY: NORMA UNI 11674

La norma tutela l'acquirente garantendo l'origine italiana e le prestazioni di sicurezza e durata del prodotto, entrambe verificate periodicamente da uno dei più importanti laboratori di prova e certificazione per il legno-arredo in Italia: COSMOB.

MADE IN ITALY: STANDARD UNI 11674

This standard protects purchasers by guaranteeing the Italian origin, safety performance and useful life of products, both periodically verified by one of the leading testing and certification labs for wooden furnishings in Italy: COSMOB.



GREENGUARD

Il Programma di Certificazione GREENGUARD certifica che tutte le strutture dei prodotti a marchio LUBE e CREO sono conformi agli standard più rigorosi in termini di livelli di emissione di Composti Organici Volatili (COV) emessi da mobili, superfici e vernice oltre ad altre sostanze chimiche nocive negli ambienti interni.

GREENGUARD

The GREENGUARD certification programme certifies that all structures of LUBE and CREO products comply with the strictest standards in terms of emissions of volatile organic compounds (VOCs) from furniture, surfaces and coatings, as well as other harmful chemical substances in interior environments.



PANNELLO ECOLOGICO

Le strutture dei mobili LUBE e CREO sono realizzate con pannelli composti da legni riciclati al 100%, certificati dal Consorzio Pannello Ecologico e con materiali a basso impatto ambientale, certificati per la bassa emissione di formaldeide.

ECOLOGICAL PANELS

LUBE and CREO structures are created with panels made from 100% recycled wood, certified by the Eco-Panel Consortium, and from environmentally friendly materials, certified for low formaldehyde emissions.



GRUPPO LUBE ECOLOGIC

Il Gruppo LUBE utilizza per i componenti delle cucine (tutte le strutture, alcune ante e alcuni complementi), materiale conforme al regolamento EPA TSCA TITLE VI, uno dei più severi in merito alle normative di salvaguardia ambientale.

ECOLOGICAL PANELS

The LUBE Group uses for kitchen components (all carcasses, some doors and some accessories), material that complies with the EPA TSCA TITLE VI regulation, one of the strictest regarding environmental protection regulations.



SOSTENIBILITÀ AMBIENTALE

Lube Industries srl è dotata di Sistemi di Gestione per l'Efficienza Ambientale, per la Qualità e per la Salute e la Sicurezza sul Lavoro, in conformità alle norme: UNI EN ISO 14001, UNI EN ISO 9001 e UNI EN ISO 45001.

ENVIRONMENTAL SUSTAINABILITY

Lube Industries S.r.l. implements management systems for environmental efficiency, quality, and occupational health and safety, in conformity to the following standards: UNI EN ISO 14001, UNI EN ISO 9001 and UNI EN ISO 45001.



FSC®

La certificazione FSC® rappresenta il principale meccanismo di garanzia sull'origine del legno o della carta, con questa certificazione Lube Industries ha deciso di rendere noto il suo impegno nei confronti dell'ambiente e si schiera contro il disboscamento incontrollato e il taglio illegale di foreste.

FSC®

FSC® certification is the leading mechanism guaranteeing the origin of wood and paper. With this certification, Lube Industries has decided to demonstrate its commitment to the environment and stand against uncontrolled deforestation and illegal felling.

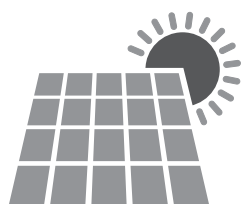

FOTOVOLTAICO

Energia pulita per prodotti di qualità. Un impianto fotovoltaico, installato nella sede aziendale, copre la superficie di 40.800 mq ed eroga una potenza di 6,2 MWp. L'energia prodotta quotidianamente dai pannelli solari, circa 6000 KWh, è in grado di soddisfare il fabbisogno dei processi produttivi aziendali.

PHOTOVOLTAICS

Clean energy for high-quality products. A photovoltaic plant, installed at the company headquarters, covers an area of 40,800 m2 and has a power output of 6.2MWp. The energy generated daily by the solar panels, approximately 6,000 KWh, is enough to meet the company's production needs.

Bridge

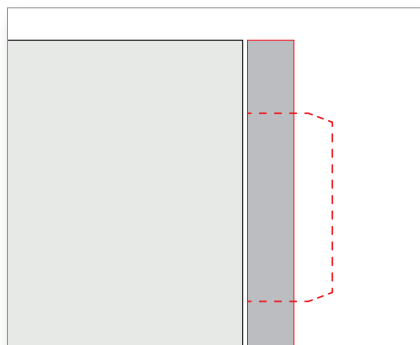

**ANTA CON PRESA MANIGLIA
INTEGRATA o PUSH-PULL**
DOOR WITH INTEGRATED HANDLE
GRIP OR PUSH-PULL



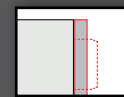

DI SERIE: Presa perimetrale su telaio
STANDARD: Perimeter grip on frame



Push-Pull e presa sul fondo non realizzabili
Push-Pull and bottom grip not possible

anta "QUADRA"
"QUADRA" door

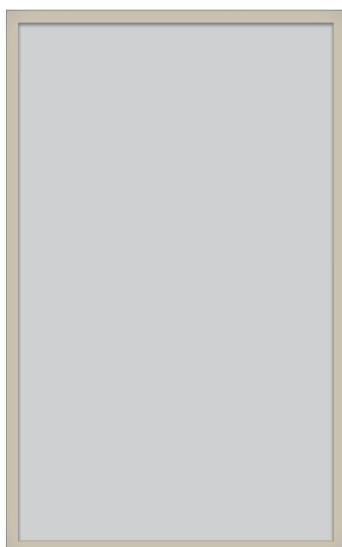

DI SERIE: Anta con maniglia laterale alta integrata su montante laterale su basi.
Anta con maniglia laterale bassa integrata su montante laterale su sopracolonne.
Anta con maniglia laterale centrale integrata su montante laterale su colonne.
Anta con maniglia inferiore centrale su traverso inferiore su pensili.

STANDARD: Door with integrated upwards lateral handle on the side of the frame on base units.
Door with integrated downwards lateral handle on the side of the frame on top-columns units.
Door with integrated central handle on the side of the frame on columns.
Door with integrated central handle on lower traverse on wall units.

SOPRACOLONNE E ANTA SUPERIORE
COLONNA FORNO:
MANIGLIA LATERALE BASSA INTEGRATA
SU MONTANTE LATERALE
TOP COLUMNS UNITS:
INTEGRATED DOWNWARDS LATERAL HANDLE
ON THE SIDE OF THE FRAME

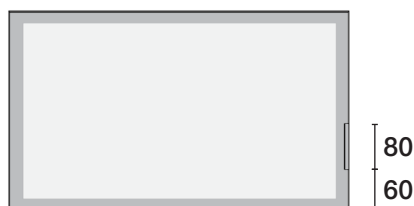

Push-Pull e presa sul fondo non realizzabili
Push-Pull and bottom grid not possible

COLONNE:
MANIGLIA LATERALE CENTRALE
INTEGRATA SU MONTANTE
LATERALE
BASE UNITS:
INTEGRATED CENTRAL HANDLE
ON THE SIDE OF THE FRAME

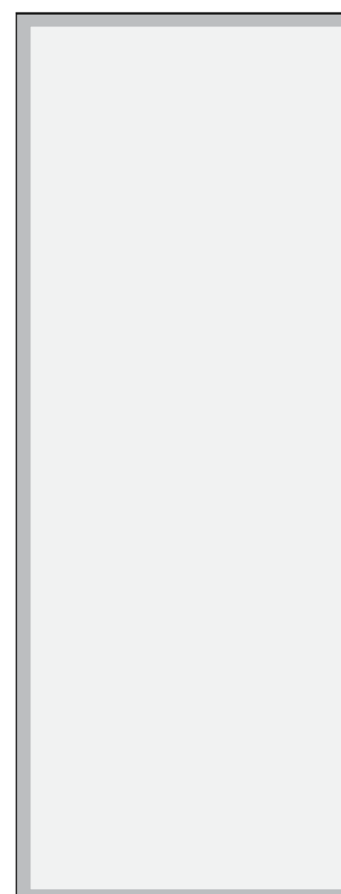

PENSILI:
MANIGLIA CENTRALE INTEGRATA
SU TRAVERSO INFERIORE
WALL UNITS:
INTEGRATED CENTRAL HANDLE
ON LOWER TRAVERSE

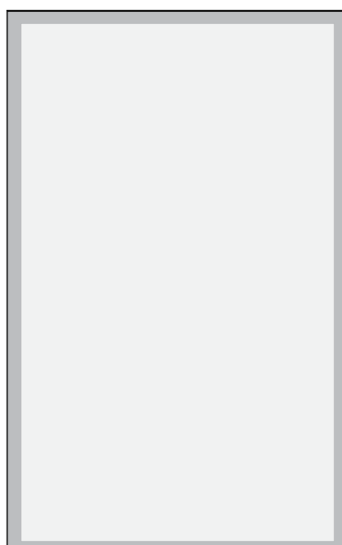

BASI e ANTA INFERIORE COLONNA FORNO:
MANIGLIA LATERALE ALTA INTEGRATA
SU MONTANTE LATERALE
BASE UNITS:
INTEGRATED UPWARDS LATERAL HANDLE
ON THE SIDE OF THE FRAME

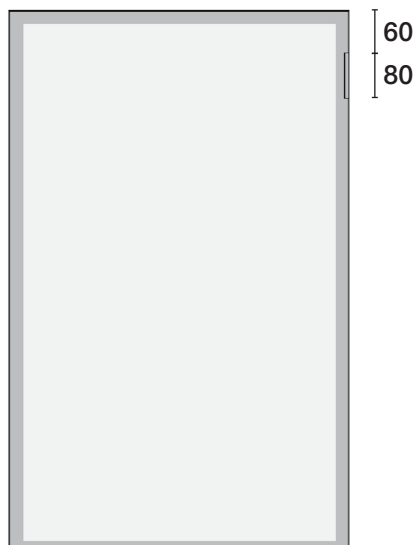

anta "SILK"
"SILK" door

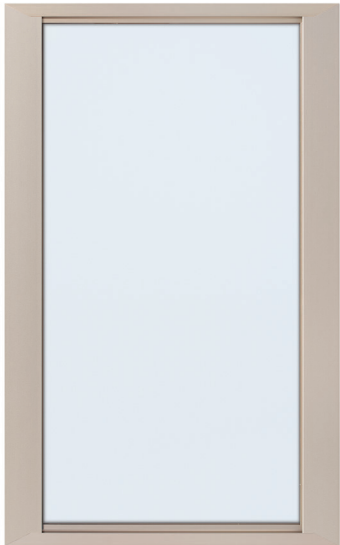

DI SERIE: Presa perimetrale su telaio
Perimeter grip on frame

A RICHIESTA: Push-Pull - Presa sul fondo su pensili
ON REQUEST: Push-Pull - Bottom grip on wall units

anta "LUMINA"
"LUMINA" door

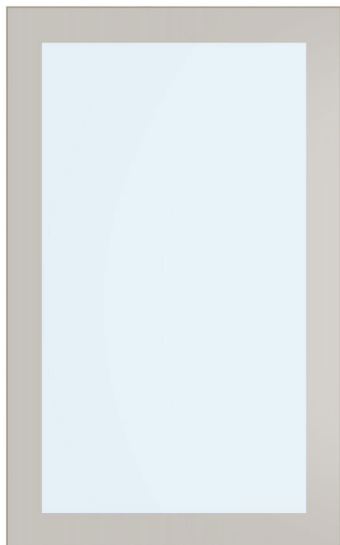

DI SERIE: Presa perimetrale su telaio
Perimeter grip on frame

A RICHIESTA: Push-Pull - Presa sul fondo su pensili
ON REQUEST: Push-Pull - Bottom grip on wall units

anta "REFLECTA"
"REFLECTA" door



DI SERIE: Push-Pull
Push-Pull

A RICHIESTA: Presa sul fondo su pensili
ON REQUEST: Bottom grip on wall units

anta "VISION"
"VISION" door

PENSILI
WALL UNITS

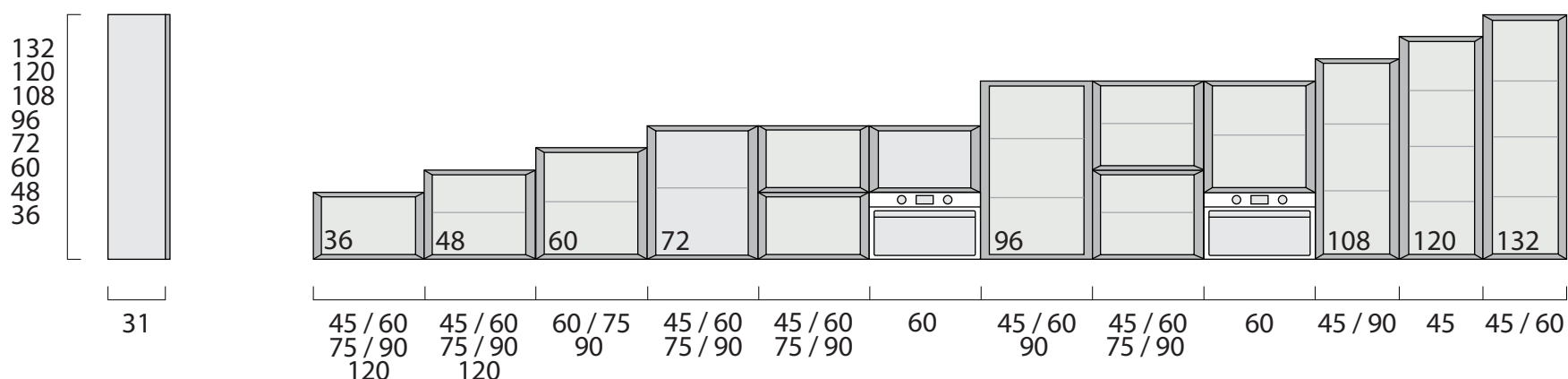

BASI ZOCCOLO H.13 BRIDGE
BRIDGE H.13 PLINTH BASE UNITS

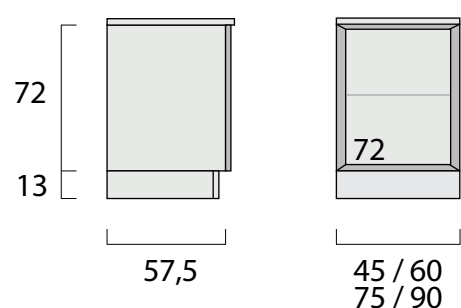

BASI ZOCCOLO H.13 NECK
NECK H.13 PLINTH BASE UNITS

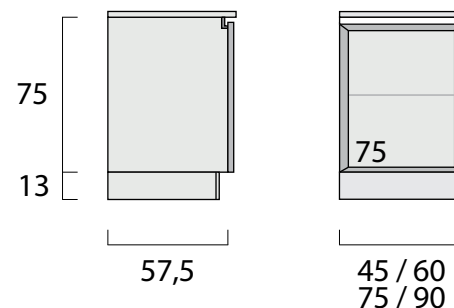

BASI ZOCCOLO H.6 BRIDGE
BRIDGE H.6 PLINTH BASE UNITS

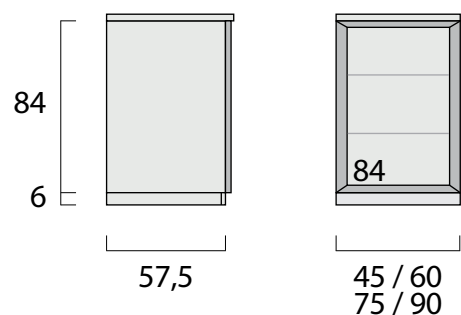

BASI ZOCCOLO H.6 NECK
NECK H.6 PLINTH BASE UNITS

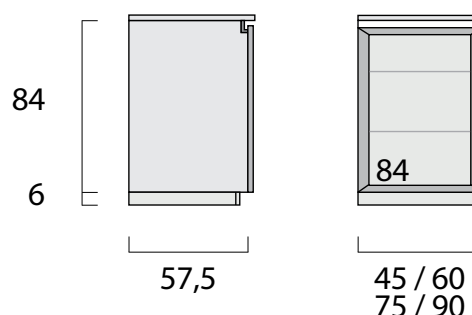

COLONNE ZOCCOLO H.13

H.13 PLINTH COLUMNS

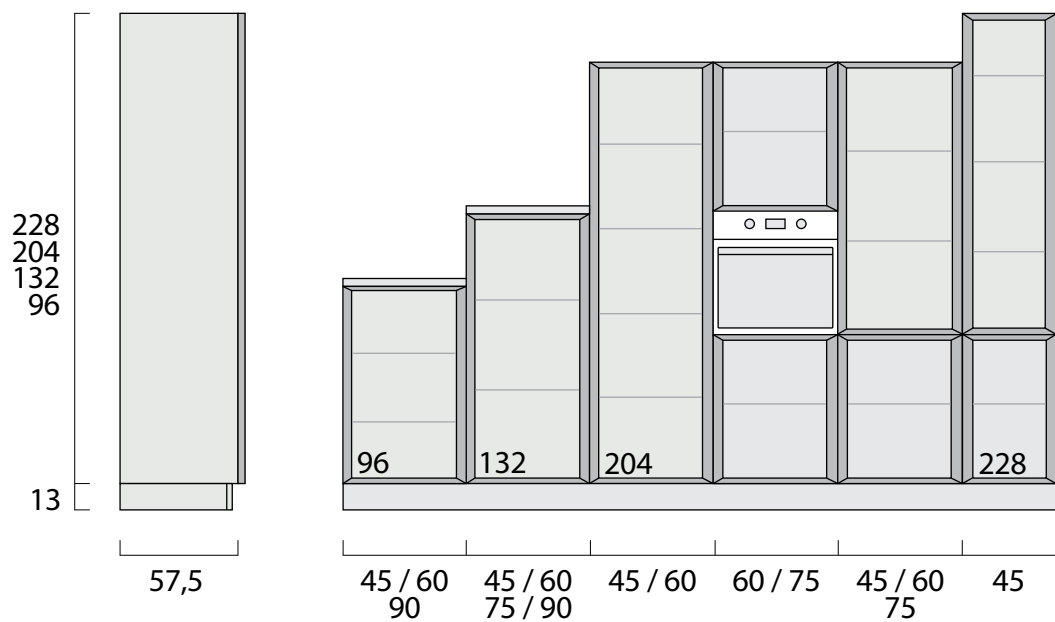

⚠ Per attrezzature interne e meccanismi di apertura vedere relative sezioni nel listino.
For internal equipment and opening mechanisms, see respective sections in the price list.

⚠ Per dimensioni dei singoli frontali vedere relative sezioni nel listino.
For size of individual doors, see respective sections in the price list.

COLONNE ZOCCOLO H.6

H.6 PLINTH COLUMNS

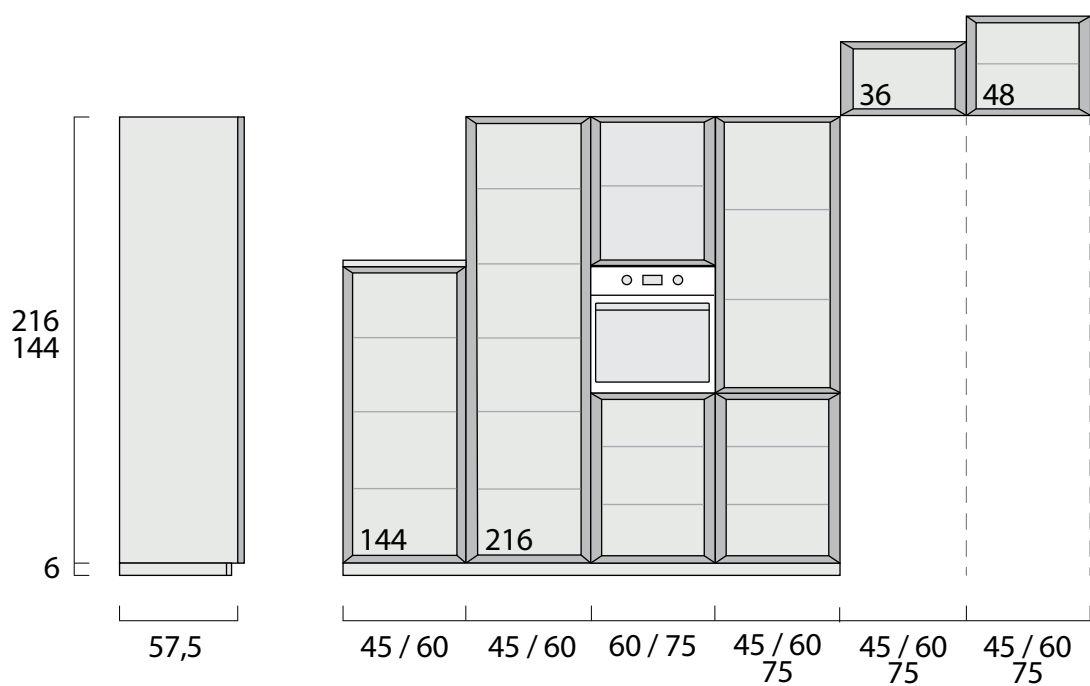

⚠ Elementi sopracolonna validi anche su colonne zoccolo H.13
Above-column elements also valid on H.13 plinth columns

TELAIO ALLUMINIO VERNICIATO FINITURA OPACA MATT FINISH PAINTED ALUMINIUM FRAME

DI SERIE: telaio alluminio verniciato titanio sp.22 mm vetro trasparente (di serie), bronzo o fumè

STANDARD: 22 mm th. titanium painted aluminium frame transparent (standard), bronze or fumè glass

telaio titanio (opz.MTIT)

titanium frame (opt.MTIT)



con vetro trasparente
(opz.TR)
with transparent glass
(opt.TR)

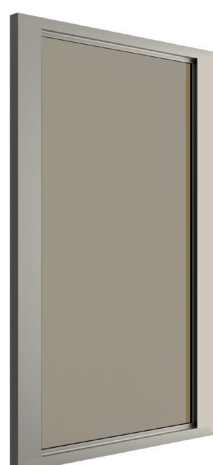

con vetro bronzo
(opz.BZ)
with bronze glass
(opt.BZ)



con vetro fumè
(opz.FE)
with fumè glass
(opt.FE)

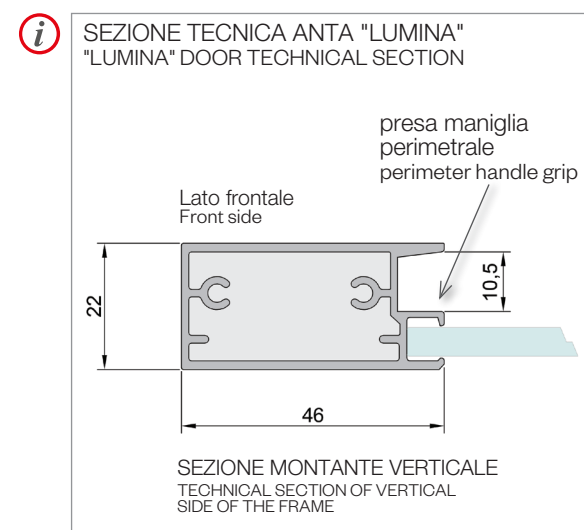

A RICHIESTA: telaio alluminio verniciato titanio sp.22 mm vetro cannettato satinato: bianco, bronzo, fumè o rame brunito

ON REQUEST: 22 mm th. titanium painted aluminium frame with reed effect satin glass: white, bronze, fumè or brushed copper

telaio titanio (opz.MTIT)

titanium frame (opt.MTIT)

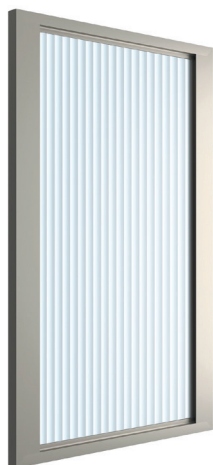

con vetro cannettato satinato bianco
(opz.BNC)
with reed effect white
satin etched glass (opt.BNC)

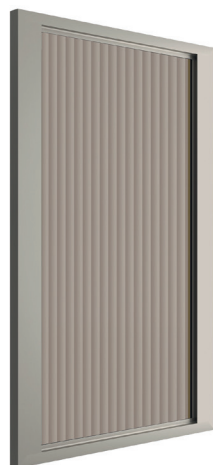

con vetro cannettato satinato bronzo
(opz.BZC)
with reed effect bronze
satin etched glass (opt.BZC)



con vetro cannettato
satinato fumè (opz.FEC)
with reed effect fumè
satin etched glass (opt.FEC)



con vetro cannettato
satinato rame brunito (opz.RBC)
with reed effect brushed copper satin
etched glass (opt.RBC)

TELAIO ALLUMINIO VERNICIATO FINITURA OPACA MATT FINISH PAINTED ALUMINIUM FRAME

A RICHIESTA: telaio alluminio verniciato nero sp.22 mm vetro trasparente, bronzo o fumè

ON REQUEST: 22 mm th. black painted aluminium frame transparent, bronze or fumè glass

telaio nero (opz.MNER)

black frame (opt.MNER)



con vetro trasparente
(opz.TR)
with transparent glass
(opt.TR)



con vetro bronzo
(opz.BZ)
with bronze glass
(opt.BZ)



con vetro fumè
(opz.FE)
with fumè glass
(opt.FE)

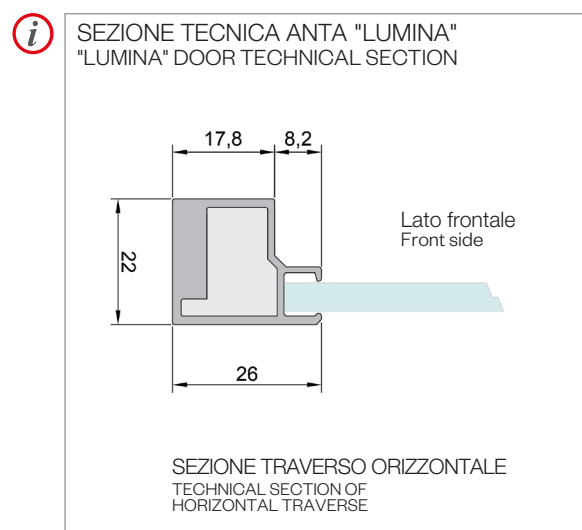

SEZIONE TRAVEVERO ORIZZONTALE
TECHNICAL SECTION OF
HORIZONTAL TRAVERSE

A RICHIESTA: telaio alluminio verniciato nero sp.22 mm vetro cannettato satinato: bianco, bronzo, fumè o rame brunito

ON REQUEST: 22 mm th. black painted aluminium frame with reed effect satin glass: white, bronze, fumè or brunched copper

telaio nero (opz.MNER)

black frame (opt.MNER)

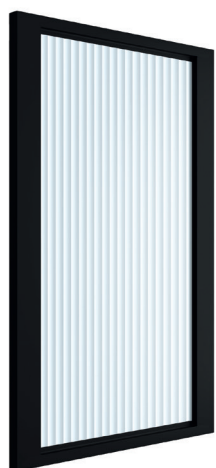

con vetro cannettato satinato bianco
(opz.BNC)
with reed effect white
satin etched glass (opt.BNC)



con vetro cannettato
satinato bronzo (opz.BZC)
with reed effect bronze
satin etched glass (opt.BZC)

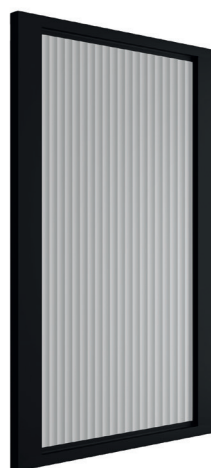

con vetro cannettato
satinato fumè (opz.FEC)
with reed effect fumè
satin etched glass (opt.FEC)

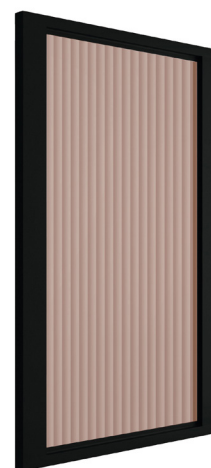

con vetro cannettato satinato rame
brunito (opz.RBC)
with reed effect brunched copper satin
etched glass (opt.RBC)

TELAIO ALLUMINIO VERNICIATO FINITURA OPACA MATT FINISH PAINTED ALUMINIUM FRAME

A RICHIESTA: telaio alluminio verniciato silver dark sp.22 mm vetro trasparente, bronzo o fumè

ON REQUEST: 22 mm th. silver dark painted aluminium frame transparent, bronze or fumè glass

telaio silver dark (opz.MDAR)

dark silver frame (opt.MDAR)

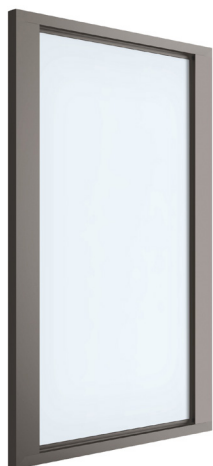

con vetro
trasparente (opz.TR)
with transparent glass (opt.TR)

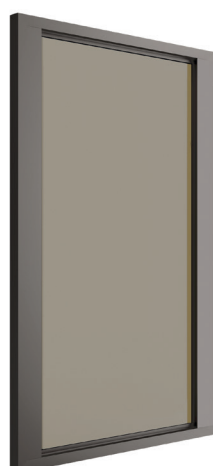

con vetro
bronzo (opz.BZ)
with bronze glass (opt.BZ)

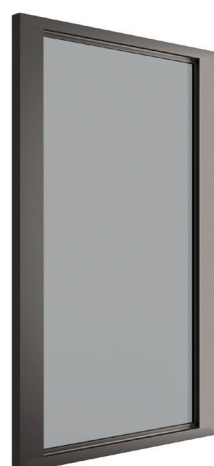

con vetro
fumè (opz.FE)
with fumè glass (opt.FE)

A RICHIESTA: telaio alluminio verniciato silver dark sp.22 mm vetro cannettato satinato:

bianco, bronzo, fumè o rame brunito

ON REQUEST: 22 mm th. silver dark painted aluminium frame with reed effect satin glass: white, bronze, fumè or brunched copper

telaio silver dark (opz.MDAR)

dark silver frame (opt.MDAR)

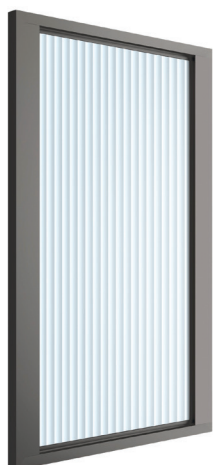

con vetro cannettato satinato
bianco (opz.BNC)
with reed effect white
satin etched glass (opt.BNC)

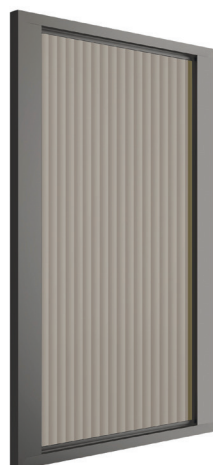

con vetro cannettato satinato
bronzo (opz.BZO)
with reed effect bronze
satin etched glass (opt.BZO)

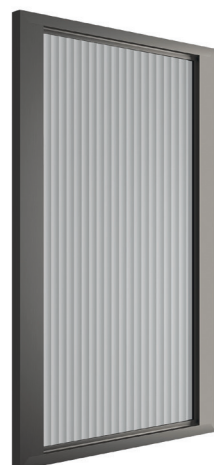

con vetro cannettato satinato
fumè (opz.FEC)
with reed effect fumè
satin etched glass (opt.FEC)

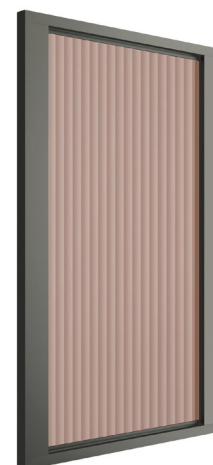

con vetro cannettato
satinato rame brunito (opz.RBC)
with reed effect brunched copper
satin etched glass (opt.RBC)

TELAIO ALLUMINIO VERNICIATO FINITURA OPACA
MATT FINISH PAINTED ALUMINIUM FRAME

A RICHIESTA: telaio alluminio verniciato umber sp.22 mm vetro trasparente, bronzo o fumè

ON REQUEST: 22 mm th. umber painted aluminium frame transparent, bronze or fumè glass

telaio umber (opz.MUMB)

umber frame (opt.MUMB)

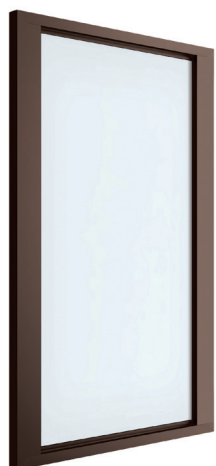

con vetro trasparente (opz.TR)
with transparent glass (opt.TR)

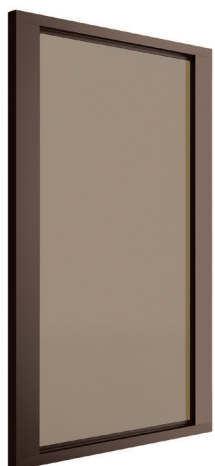

con vetro bronzo (opz.BZ)
with bronze glass (opt.BZ)

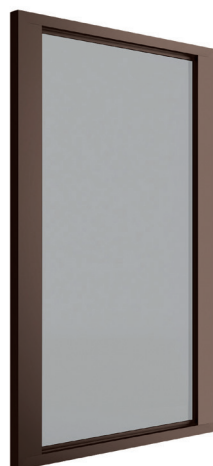

con vetro fumè (opz.FE)
with fumè glass (opt.FE)



A RICHIESTA: telaio alluminio verniciato umber sp.22 mm vetro cannettato satinato:

bianco, bronzo, fumè o rame brunito

ON REQUEST: 22 mm th. umber painted aluminium frame with reed effect satin glass: white, bronze, fumè or burnished copper

telaio umber (opz.MUMB)

umber frame (opt.MUMB)

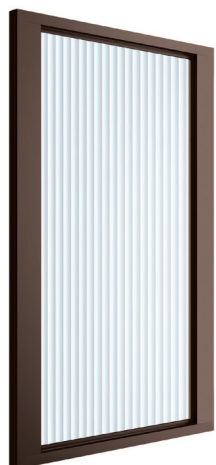

con vetro cannettato satinato bianco (opz.BNC)
with reed effect white satin etched glass (opt.BNC)

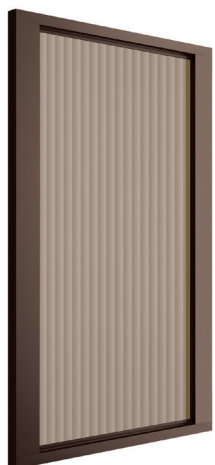

con vetro cannettato satinato bronzo (opz.BZC)
with reed effect bronze satin etched glass (opt.BZC)

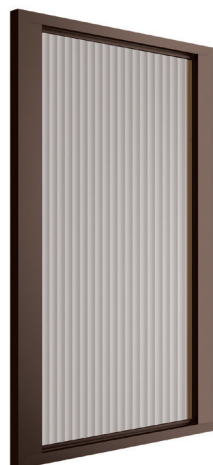

on vetro cannettato satinato fumè (opz.FEC)
with reed effect fumè satin etched glass (opt.FEC)

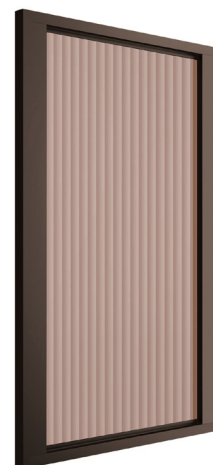

con vetro cannettato rame brunito (opz.RBC)
with reed effect burnished copper satin etched glass (opt.RBC)

TELAIO ALLUMINIO VERNICIATO FINITURA OPACA MATT FINISH PAINTED ALUMINIUM FRAME

A RICHIESTA: telaio alluminio verniciato ottone sp.22 mm vetro trasparente, bronzo o fumè

ON REQUEST: 22 mm th. brass painted aluminium frame transparent, bronze or fumè glass

telaio ottone (opz.MOTT)

brass frame (opt.MOTT)

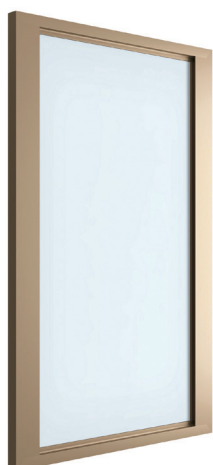

con vetro trasparente
(opz. TR)
with transparent glass
(opt. TR)

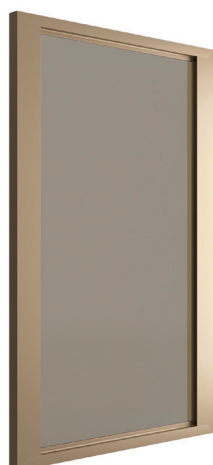

con vetro bronzo
(opz. BZ)
with bronze glass
(opt. BZ)

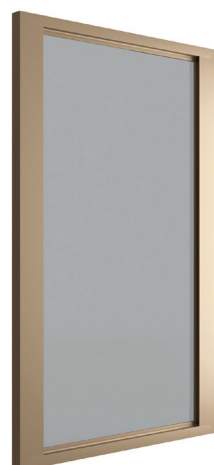

con vetro fumè
(opz. FE)
with fumè glass
(opt. FE)

A RICHIESTA: telaio alluminio verniciato ottone sp.22 mm vetro cannettato satinato:

bianco, bronzo, fumè o rame brunito

ON REQUEST: 22 mm th. brass painted aluminium frame with reed effect satin glass: white, bronze, fumè or brunched copper

telaio ottone (opz.MOTT)

brass frame (opt.MOTT)

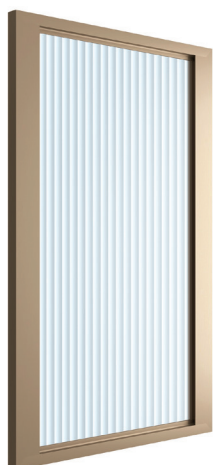

con vetro cannettato
satinato bianco (opz. BNC)
with reed effect white
satin etched glass (opt. BNC)

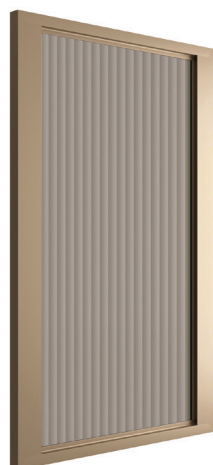

con vetro cannettato
satinato bronzo (opz. BZC)
with reed effect bronze
satin etched glass (opt. BZC)

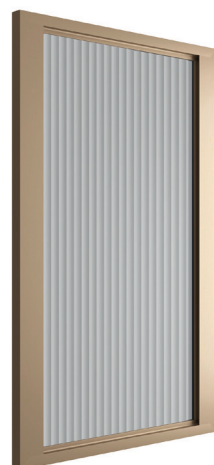

con vetro cannettato
satinato fumè (opz. FEC)
with reed effect fumè
satin etched glass (opt. FEC)

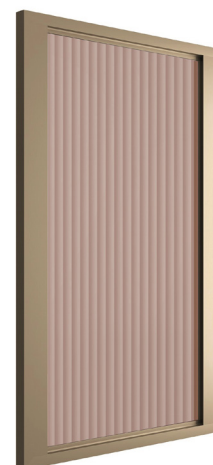

con vetro cannettato
satinato rame brunito (opz. RBC)
with reed effect brunched copper satin
etched glass (opt. RBC)

TELAIO ALLUMINIO VERNICIATO FINITURA OPACA MATT FINISH PAINTED ALUMINIUM FRAME

A RICHIESTA: telaio alluminio verniciato rame brunito sp.22 mm vetro trasparente, bronzo o fumè

ON REQUEST: 22 mm th. copper brunched painted aluminium frame transparent, bronze or fumè glass

telaio rame (opz.MRAM)

copper frame (opt.MRAM)

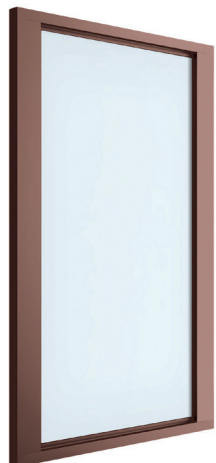

con vetro
trasparente (opz.TR)
with transparent glass
(opt.TR)

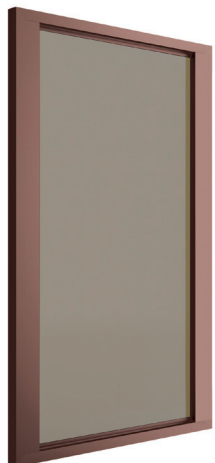

con vetro
bronzo (opz.BZ)
with bronze glass
(opt.BZ)

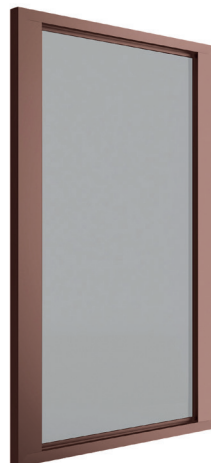

con vetro
fumè (opz.FE)
with fumè glass
(opt.FE)

A RICHIESTA: telaio alluminio verniciato rame brunito sp.22 mm vetro cannettato satinato:

bianco, bronzo, fumè o rame brunito

ON REQUEST: 22 mm th. brunched copper painted aluminium frame with reed effect satin glass: white, bronze, fumè or brunched copper

telaio rame (opz.MRAM)

copper frame (opt.MRAM)

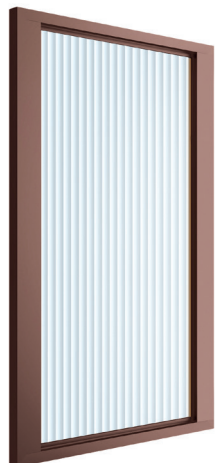

con vetro cannettato
satinato bianco (opz.BNC)
with reed effect
white satin etched glass (opt.BNC)

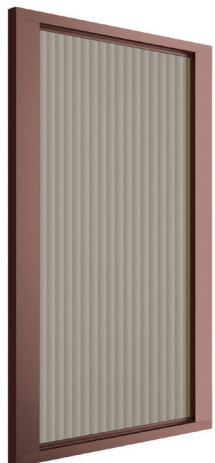

con vetro cannettato
satinato bronzo (opz.BZC)
with reed effect
bronze satin etched glass (opt.BZC)

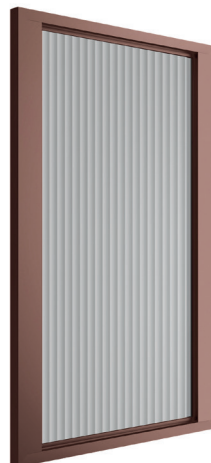

con vetro cannettato
satinato fumè (opz.FEC)
with reed effect
fumè satin etched glass (opt.FEC)

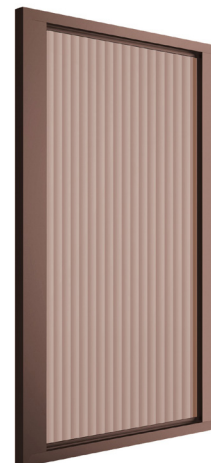

con vetro cannettato
satinato rame brunito (opz.RBC)
with reed effect
brunched copper satin etched glass (opt.RBC)

SCHIENA EFFETTO MARMO

BACK PANEL MARBLE EFFECT

PENSILI

WALL UNITS

H 36-48	L 45 L 60 L 75 L 90 L 120
H 60	L 60 L 75 L 90
H 72	L 45 L 60 L 75 L 90
H 96	L 45 L 60 L 75 L 90
H 108	L 45 L 60 L 90
H 120	L 45 L 60

BASI

BASE UNITS

H 72	L 45 L 60 L 75 L 90
H 75	L 45 L 60 L 75 L 90
H 84	L 45 L 60 L 75 L 90

COLONNE

COLUMNS

H 96	L 45 L 60 L 90
H 132	L 45 L 60 L 75 L 90
H 144	L 45 L 60
H 204	L 45 L 60 L 75
H 216	L 45 L 60 L 75

COLORI SCHIENA BACK PANEL COLOUR

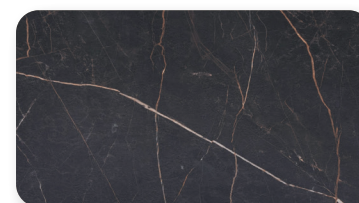

samas finitura urban (opz.3482)



calacatta finitura MN (opz.6019)

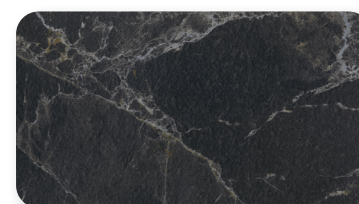

dark finitura MN (opz.6133)

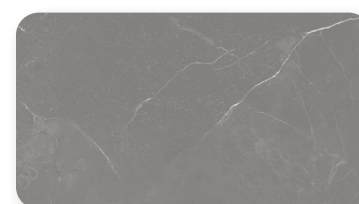

pietra grigia fin.velvet (opz.2669)



