

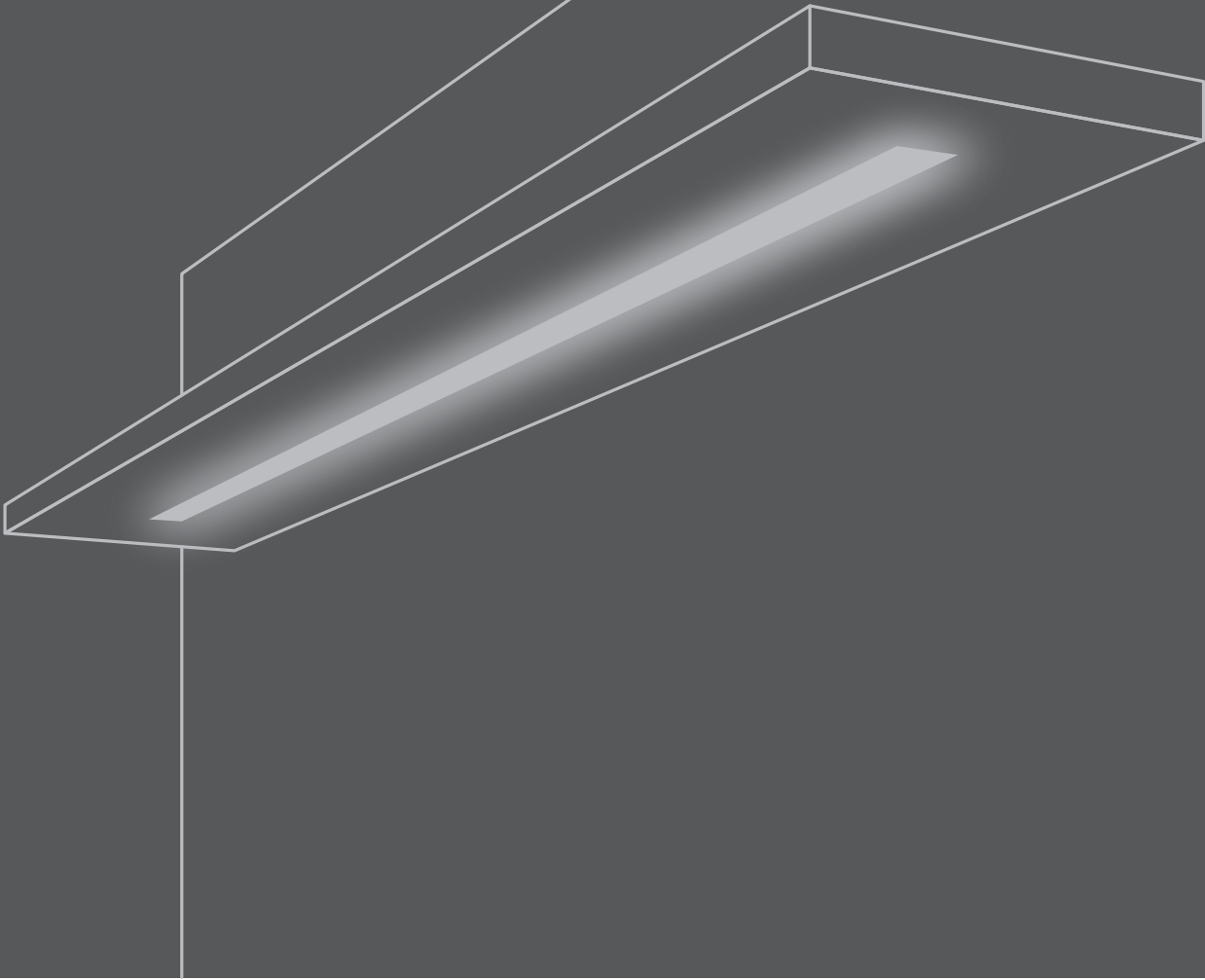

GRUPPOLUBE



# LUCI E DISPOSITIVI ELETTRICI

## LIGHTS AND ELECTRICAL DEVICES

■ Luci L&S.....pag. 3  
L&S lights

■ Luci Ital Pek.....pag. 41  
Ital Pek lights



# SOLUZIONI DI ILLUMINAZIONE L&S

## L&S LIGHTING SOLUTIONS

**L&S** | LIGHTING  
INTELLIGENCE



### MULTITENSIONE

Input: 100\240VAC Output: 24 VDC

### MULTI-VOLTAGE

Input: 100\240VAC Output: 24 VDC



### CERTIFICAZIONI INTERNAZIONALI

ALL LEADING INTERNATIONAL ACCREDITATIONS



### EMOTION DUAL COLOR

La temperatura colore varia da bianco "caldo" a "naturale" (3000-4000K).

**N.B.: tutte le luci riportate a listino sono in versione Dual Color**

The colour temperature varies from "warm" to "natural" white (3000-4000K).

**Note: all the lights included in this price list are in Dual Color version**

# SOMMARIO INDEX

## LUCI LINEARI LINEAR LIGHTS



### MINI NOOR

MINI NOOR 8



### LUGANO IP44

LUGANO IP44 10



### KITON

KITON 12



### KENDO

KENDO 14  
KENDO IN 16  
KENDO IN IRS 17

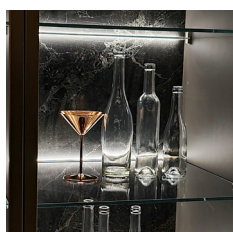

### VIVARA 8

VIVARA 8 18

## FARETTI SPOTLIGHTS

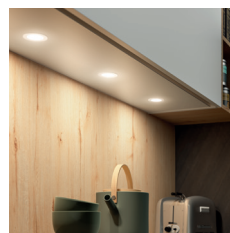

### SUNRISE 58

SUNRISE 58 20

## LED STRIP LED STRIP

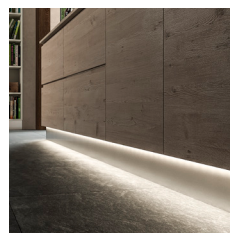

### STRIP REEL

STRIP REEL 22

## LED INCASSO LIBRERIE A SPALLA RECESSED LED SYSTEM FOR BOOKCASES WITH FINISHING SIDES



### SIRENUSE

SIRENUSE 26

## MINI LUCI LINEARI LINEAR MINI LIGHTS



### LINEA\_8 MM

LINEA\_8 MM 28

## ELETTRONICA E CONTROLLO ELECTRONICS AND CONTROL



### TIPI DI ACCENSIONE

BASILARE (KIT BASE)	30
CON SENSORE	31
CON TELECOMANDO	32
CON APP/TELECOMANDO	33



### MODULI

MOLTIPLICATORE IN	34
PROLUNGA	34
CENTRALINA "SMART 1"	35
CENTRALINA "SMART 4"	35



### TELECOMANDI/APP

TELECOMANDO "SMART UP 4"	36
INTERRUTTORE PUCKY	37
APP BLUESMART	38

## SANITATION

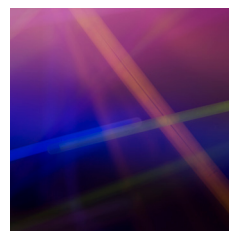

### BLUE LIGHT

BLUE LIGHT	40
------------	----

Foto ambientata



## MINI NOOR

**Interno pensile/colonna/elementi in folding sp. 18 o sotto mensola**  
Mini Noor è un profilo luminoso inclinato ad incasso particolarmente sottile (8 mm), trova applicazione in verticale integrato nei fianchi dei mobili e come sotto mensola. La sorgente LED Emotion Dual Color permette la variazione da 3000K a 4000K garantendo un comfort visivo ottimale.

**Inside wall unit/column/folding unit th. 18 or under shelf**  
Mini Noor is a particularly thin recessed inclined light profile (8 mm), it can be applied vertically integrated into the sides of the furniture or under shelf. The Emotion Dual Color LED source allows the variation from 3000K to 4000K, guaranteeing optimal visual comfort.

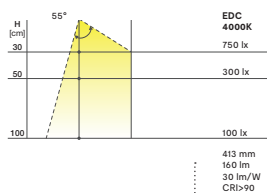

8 | LUCI E DISPOSITIVI ELETTRICI

Nome prodotto

Testo descrittivo

Illuminamento

Foto prodotto

## MINI NOOR



**N.B. per il montaggio della luce gli elementi in folding hanno un foro sul cielo e sul fondo**  
Note: 'folding' unit have a hole on the top and the bottom for assembly

Nero

Larghezza/Altezza del mobile

Disegno tecnico

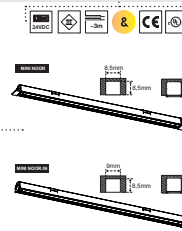

MINI NOOR PER MENSOLE				codice
90600560300BED	3 W	260 mm	3000-4000K (L 300 mm)	08618280
90600570300BED	5 W	410 mm	3000-4000K (L 450 mm)	08618281
90600580300BED	7.2 W	560 mm	3000-4000K (L 600 mm)	08618282
90600590300BED	11.1 W	860 mm	3000-4000K (L 900 mm)	08618283
90600600300BED	15.2 W	1160 mm	3000-4000K (L 1200 mm)	08618284
90600610300BED	19.2 W	1460 mm	3000-4000K (L 1500 mm)	08618285
90600620300BED	23.3 W	1760 mm	3000-4000K (L 1800 mm)	08618286
90600630300BED	27.3 W	2060 mm	3000-4000K (L 2100 mm)	08618287
90600640300BED	31.4 W	2360 mm	3000-4000K (L 2400 mm)	08618288
90600650300BED	35.4 W	2660 mm	3000-4000K (L 2700 mm)	08618289
90600660300BED	39.5 W	2960 mm	3000-4000K (L 3000 mm)	08618290

MINI NOOR.IN PER FIANCHI PENSILI/COLOGNE/FOLDING 1 VANO				codice
90700670300BED	4.1 W	323 mm	3000-4000K (H 360 mm)	08618300
90700680300BED	5.7 W	443 mm	3000-4000K (H 480 mm)	08618301
90700690300BED	7.4 W	563 mm	3000-4000K (H 600 mm)	08618302
90700700300BED	8.8 W	683 mm	3000-4000K (H 720 mm)	08618303
90700710300BED	12.2 W	923 mm	3000-4000K (H 960 mm)	08618304
90700720300BED	13.8 W	1043 mm	3000-4000K (H 1080 mm)	08618305
90700730300BED	15.5 W	1163 mm	3000-4000K (H 1200 mm)	08618306
90700740300BED	16.9 W	1283 mm	3000-4000K (H 1320 mm)	08618307
90700750300BED	18.6 W	1403 mm	3000-4000K (H 1440 mm)	08618308
90700760300BED	26.7 W	2003 mm	3000-4000K (H 2040 mm)	08618309
90700770300BED	28.3 W	2123 mm	3000-4000K (H 2160 mm)	08618310
90700780300BED	30 W	2243 mm	3000-4000K (H 2280 mm)	08618311

MINI NOOR.IN PER FIANCHI COLONNE 2 VANI				codice
90700790300BED	9.1 W	693 mm	3000-4000K (H 720 mm)	08618315
90700800300BED	10.8 W	813 mm	3000-4000K (H 840 mm)	08618316
90700900300BED	12.2 W	933 mm	3000-4000K (H 960 mm)	08618314
90700810300BED	17.2 W	1293 mm	3000-4000K (H 1320 mm)	08618317
90700830300BED	18.6 W	1413 mm	3000-4000K (H 1450 mm)	08618318
90700820300BED	20.3 W	1533 mm	3000-4000K (H 1560 mm)	08618319

### KIT DI CONTROLLO CONSIGLIATI

**KIT 2\_Accensione con sensore all'apertura dell'anta**  
Vedi pag 31

**KIT 3\_Accensione con telecomando 1 zona**  
Vedi pag 32

**KIT 4\_Accensione con app "BlueSmart" o telecomando 4 zone**  
Vedi pag 33

**KIT 5\_Accensione con app "BlueSmart" o telecomando 4 zone**  
Vedi pag 33

**KIT 6\_Accensione con app "BlueSmart" o telecomando 4 zone**  
Vedi pag 33

**KIT 7\_Accensione con app "BlueSmart" o telecomando 4 zone**  
Vedi pag 33

**KIT 8\_Accensione con app "BlueSmart" o telecomando 4 zone**  
Vedi pag 33

**KIT 9\_Accensione con app "BlueSmart" o telecomando 4 zone**  
Vedi pag 33

**KIT 10\_Accensione con app "BlueSmart" o telecomando 4 zone**  
Vedi pag 33

**KIT 11\_Accensione con app "BlueSmart" o telecomando 4 zone**  
Vedi pag 33

**KIT 12\_Accensione con app "BlueSmart" o telecomando 4 zone**  
Vedi pag 33

**KIT 13\_Accensione con app "BlueSmart" o telecomando 4 zone**  
Vedi pag 33

**KIT 14\_Accensione con app "BlueSmart" o telecomando 4 zone**  
Vedi pag 33

**KIT 15\_Accensione con app "BlueSmart" o telecomando 4 zone**  
Vedi pag 33

**KIT 16\_Accensione con app "BlueSmart" o telecomando 4 zone**  
Vedi pag 33

**KIT 17\_Accensione con app "BlueSmart" o telecomando 4 zone**  
Vedi pag 33

**KIT 18\_Accensione con app "BlueSmart" o telecomando 4 zone**  
Vedi pag 33

**KIT 19\_Accensione con app "BlueSmart" o telecomando 4 zone**  
Vedi pag 33

**KIT 20\_Accensione con app "BlueSmart" o telecomando 4 zone**  
Vedi pag 33

**KIT 21\_Accensione con app "BlueSmart" o telecomando 4 zone**  
Vedi pag 33

**KIT 22\_Accensione con app "BlueSmart" o telecomando 4 zone**  
Vedi pag 33

**KIT 23\_Accensione con app "BlueSmart" o telecomando 4 zone**  
Vedi pag 33

**KIT 24\_Accensione con app "BlueSmart" o telecomando 4 zone**  
Vedi pag 33

**KIT 25\_Accensione con app "BlueSmart" o telecomando 4 zone**  
Vedi pag 33

**KIT 26\_Accensione con app "BlueSmart" o telecomando 4 zone**  
Vedi pag 33

**KIT 27\_Accensione con app "BlueSmart" o telecomando 4 zone**  
Vedi pag 33

**KIT 28\_Accensione con app "BlueSmart" o telecomando 4 zone**  
Vedi pag 33

**KIT 29\_Accensione con app "BlueSmart" o telecomando 4 zone**  
Vedi pag 33

**KIT 30\_Accensione con app "BlueSmart" o telecomando 4 zone**  
Vedi pag 33

**KIT 31\_Accensione con app "BlueSmart" o telecomando 4 zone**  
Vedi pag 33

**KIT 32\_Accensione con app "BlueSmart" o telecomando 4 zone**  
Vedi pag 33

**KIT 33\_Accensione con app "BlueSmart" o telecomando 4 zone**  
Vedi pag 33

**KIT 34\_Accensione con app "BlueSmart" o telecomando 4 zone**  
Vedi pag 33

**KIT 35\_Accensione con app "BlueSmart" o telecomando 4 zone**  
Vedi pag 33

**KIT 36\_Accensione con app "BlueSmart" o telecomando 4 zone**  
Vedi pag 33

**KIT 37\_Accensione con app "BlueSmart" o telecomando 4 zone**  
Vedi pag 33

**KIT 38\_Accensione con app "BlueSmart" o telecomando 4 zone**  
Vedi pag 33

**KIT 39\_Accensione con app "BlueSmart" o telecomando 4 zone**  
Vedi pag 33

**KIT 40\_Accensione con app "BlueSmart" o telecomando 4 zone**  
Vedi pag 33

**KIT 41\_Accensione con app "BlueSmart" o telecomando 4 zone**  
Vedi pag 33

**KIT 42\_Accensione con app "BlueSmart" o telecomando 4 zone**  
Vedi pag 33

**KIT 43\_Accensione con app "BlueSmart" o telecomando 4 zone**  
Vedi pag 33

**KIT 44\_Accensione con app "BlueSmart" o telecomando 4 zone**  
Vedi pag 33

**KIT 45\_Accensione con app "BlueSmart" o telecomando 4 zone**  
Vedi pag 33

**KIT 46\_Accensione con app "BlueSmart" o telecomando 4 zone**  
Vedi pag 33

**KIT 47\_Accensione con app "BlueSmart" o telecomando 4 zone**  
Vedi pag 33

**KIT 48\_Accensione con app "BlueSmart" o telecomando 4 zone**  
Vedi pag 33

**KIT 49\_Accensione con app "BlueSmart" o telecomando 4 zone**  
Vedi pag 33

**KIT 50\_Accensione con app "BlueSmart" o telecomando 4 zone**  
Vedi pag 33

**KIT 51\_Accensione con app "BlueSmart" o telecomando 4 zone**  
Vedi pag 33

**KIT 52\_Accensione con app "BlueSmart" o telecomando 4 zone**  
Vedi pag 33

**KIT 53\_Accensione con app "BlueSmart" o telecomando 4 zone**  
Vedi pag 33

**KIT 54\_Accensione con app "BlueSmart" o telecomando 4 zone**  
Vedi pag 33

**KIT 55\_Accensione con app "BlueSmart" o telecomando 4 zone**  
Vedi pag 33

**KIT 56\_Accensione con app "BlueSmart" o telecomando 4 zone**  
Vedi pag 33

**KIT 57\_Accensione con app "BlueSmart" o telecomando 4 zone**  
Vedi pag 33

**KIT 58\_Accensione con app "BlueSmart" o telecomando 4 zone**  
Vedi pag 33

**KIT 59\_Accensione con app "BlueSmart" o telecomando 4 zone**  
Vedi pag 33

**KIT 60\_Accensione con app "BlueSmart" o telecomando 4 zone**  
Vedi pag 33

**KIT 61\_Accensione con app "BlueSmart" o telecomando 4 zone**  
Vedi pag 33

**KIT 62\_Accensione con app "BlueSmart" o telecomando 4 zone**  
Vedi pag 33

**KIT 63\_Accensione con app "BlueSmart" o telecomando 4 zone**  
Vedi pag 33

**KIT 64\_Accensione con app "BlueSmart" o telecomando 4 zone**  
Vedi pag 33

**KIT 65\_Accensione con app "BlueSmart" o telecomando 4 zone**  
Vedi pag 33

### Alimentazione



24 VDC  
tensione costante



220-240V~  
tensione in ingresso

### Classe di isolamento



Classe III

### Sorgente



Emotion Dual Color  
(3000÷4000K) EDC  
Bianco Naturale  
Caldo

### Pittogrammi



~2,5m Lunghezza del cavo



Dimmerabile



Interruttore a infrarossi



Connessione wireless



Bluetooth



IP20 Indice di protezione IP



Articolo stagionale



Connessione in fila  
continua

### Certificazioni



European  
Conformity



European Norms  
Electrical Cert.



cULus



EurAsian Conformity



China Compulsory  
Certificate



RCM Certification



Korea Certification

Kit di gestione consigliati o obbligatori

### Finiture



Nero



Alluminio anodizzato



Acciaio spazzolato



Metallic grey



Oro



## MINI NOOR

### Interno pensile/colonna/elementi in folding sp. 18 o sotto mensola

Mini Noor è un profilo luminoso inclinato ad incasso particolarmente sottile (8 mm), trova applicazione in verticale integrato nei fianchi dei mobili o come sotto mensola. La sorgente LED Emotion Dual Color permette la variazione da 3000K a 4000K garantendo un comfort visivo ottimale.

### Inside wall unit/column/folding unit th. 18 or under shelf

Mini Noor is a particularly thin recessed inclined light profile (8 mm), it can be applied vertically integrated into the sides of the furniture or under shelf. The Emotion Dual Color LED source allows the variation from 3000K to 4000K, guaranteeing optimal visual comfort.

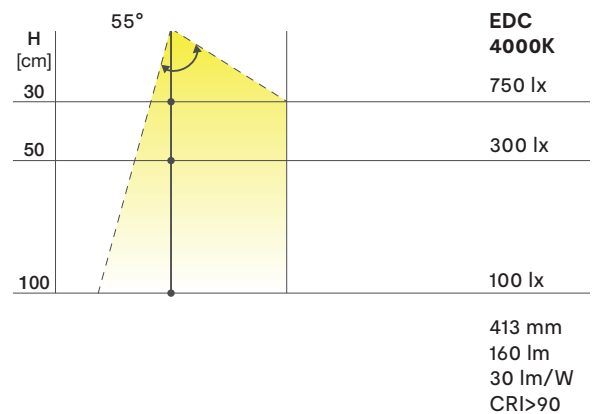



# MINI NOOR

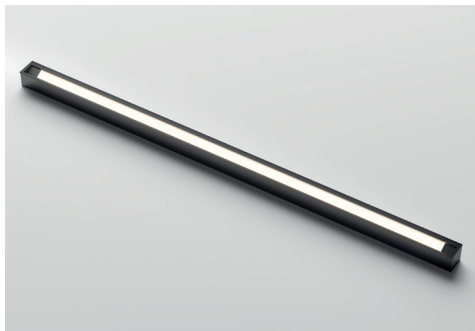

**N.B.: per il montaggio della luce gli elementi in folding hanno un foro sul cielo e sul fondo**  
**Note: folding unit have a hole on the top and the bottom for assembly**

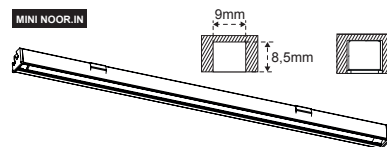
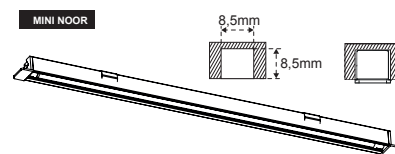
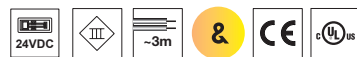

MINI NOOR PER MENSOLE						codice code
	90600560300BED	3 W	260 mm	3000-4000K	(L 300 mm)	08618280
	90600570300BED	5 W	410 mm	3000-4000K	(L 450 mm)	08618281
	90600580300BED	7,2 W	560 mm	3000-4000K	(L 600 mm)	08618282
	90600590300BED	11,1 W	860 mm	3000-4000K	(L 900 mm)	08618283
	90600600300BED	15,2 W	1160 mm	3000-4000K	(L 1200 mm)	08618284
	90600610300BED	19,2 W	1460 mm	3000-4000K	(L 1500 mm)	08618285
	90600620300BED	23,3 W	1760 mm	3000-4000K	(L 1800 mm)	08618286
	90600630300BED	27,3 W	2060 mm	3000-4000K	(L 2100 mm)	08618287
	90600640300BED	31,4 W	2360 mm	3000-4000K	(L 2400 mm)	08618288
	90600650300BED	35,4 W	2660 mm	3000-4000K	(L 2700 mm)	08618289
	90600660300BED	39,5 W	2960 mm	3000-4000K	(L 3000 mm)	08618290

MINI NOOR.IN PER FIANCHI PENSILI/COLONNE/FOLDING 1 VANO						codice code
	90700670300BED	4,1 W	323 mm	3000-4000K	(H 360 mm)	08618300
	90700680300BED	5,7 W	443 mm	3000-4000K	(H 480 mm)	08618301
	90700690300BED	7,4 W	563 mm	3000-4000K	(H 600 mm)	08618302
	90700700300BED	8,8 W	683 mm	3000-4000K	(H 720 mm)	08618303
	90700710300BED	12,2 W	923 mm	3000-4000K	(H 960 mm)	08618304
	90700720300BED	13,8 W	1043 mm	3000-4000K	(H 1080 mm)	08618305
	90700730300BED	15,5 W	1163 mm	3000-4000K	(H 1200 mm)	08618306
	90700740300BED	16,9 W	1283 mm	3000-4000K	(H 1320 mm)	08618307
	90700750300BED	18,6 W	1403 mm	3000-4000K	(H 1440 mm)	08618308
	90700760300BED	26,7 W	2003 mm	3000-4000K	(H 2040 mm)	08618309
	90700770300BED	28,3 W	2123 mm	3000-4000K	(H 2160 mm)	08618310
	90700780300BED	30 W	2243 mm	3000-4000K	(H 2280 mm)	08618311

MINI NOOR.IN PER FIANCHI COLONNE 2 VANI						codice code
	90700790300BED	9,1 W	693 mm	3000-4000K	(H 720 mm)	08618315
	90700800300BED	10,8 W	813 mm	3000-4000K	(H 840 mm)	08618316
	90700900300BED	12,2 W	933 mm	3000-4000K	(H 960 mm)	08618314
	90700810300BED	17,2 W	1293 mm	3000-4000K	(H 1320 mm)	08618317
	90700830300BED	18,6 W	1413 mm	3000-4000K	(H 1450 mm)	08618318
	90700820300BED	20,3 W	1533 mm	3000-4000K	(H 1560 mm)	08618319

## TIPDI ACCENSIONE POWER SWITCH ON TYPES

**Accensione con sensore all'apertura dell'anta**  
 (Vedi pag.31)  
 Switch on with sensor on the door opening  
 (See page 31)

**Accensione con telecomando (1 zona)**  
 (Vedi pag.32)  
 Switch on with remote control (1 area)  
 (See page 32)

**Accensione con app "BlueSmart" o telecomando (4 zone)**  
 (Vedi pag.33)  
 Switch on with "BlueSmart" app or remote control (4 areas)  
 (See page 33)



## EMOTION DUAL COLOR

La temperatura colore varia da bianco "caldo" a "naturale" (3000-4000K) variabile tramite telecomando o cambio spinotto cavo

The colour temperature varies from "warm" to "natural" white (3000-4000K) variable via remote control or cable plug change

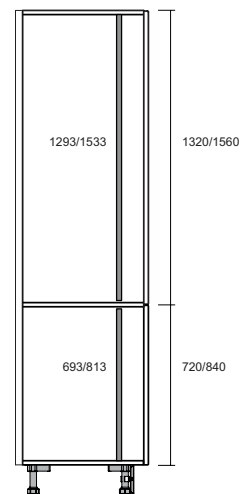

Schema fianchi colonne 2 vani  
2 compartment column sides diagram



# LUGANO IP44

## Sottopensile

Lugano IP44 è un profilo lineare sottopensile con ottica inclinata che consente l'emissione di luce diffusa ed omogenea sul piano di lavoro. L'installazione, tramite clip incluse nella confezione, è semplice e possibile anche in punti soggetti a schizzi d'acqua, grazie all'indice di protezione IP44. La sorgente LED Emotion Dual Color permette la variazione da 3000K a 4000K, garantendo un comfort visivo ottimale. Il sensore IR Switch di prossimità integrato consente l'accensione e la variazione di temperatura nella versione EDC.

## Under wall unit

Lugano IP44 is a linear profile under the wall unit with inclined optics that allows the emission of diffused and homogeneous light on the work surface. Installation, using clips included in the package, is simple and possible even in areas subject to water splashes, thanks to the protection index IP44. The LED source Emotion Dual Color colour temperature which allows the variation from 3000K to 4000K for optimal visual comfort. The integrated IR proximity switch enables the ignition and temperature change in the EDC version.

H [cm]	Natural 4000K	EDC 4000K
30	615 lx	675 lx
50	320 lx	355 lx
100	115 lx	125 lx

900 mm  
428 lm  
40 lm/W  
CRI>80

# LUGANO IP44

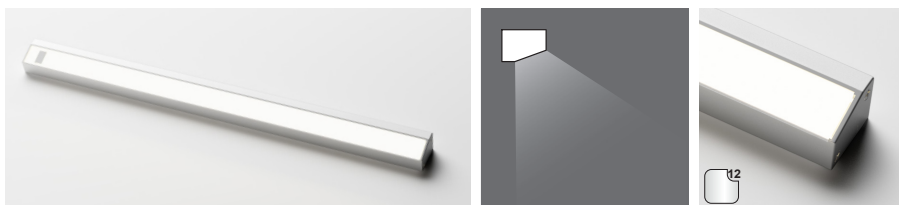

Alluminio anodizzato

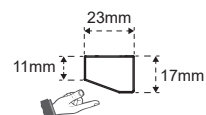
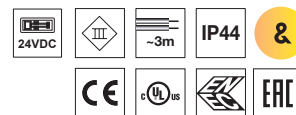

Simulazione di applicazione Lugano IP44 con Dual Blue sottopensile (attiva per 2 ore)  
Lugano IP44 simulation under wall unit with Dual Blue (operative for 2 hours)

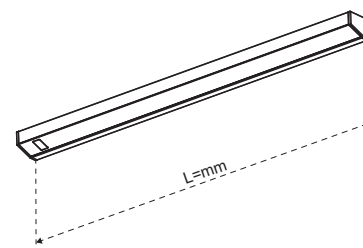

**N.B.: la luce può essere inserita anche sotto lo scolapiatti**  
Note: the light can be insert under plate-rack unit

LUGANO IP44 IRS EDC 24 V					codice code
	20600951200AHD	2,6 W	300 mm	3000-4000K	08618100
	20600961200AHD	4,5 W	450 mm	3000-4000K	08618101
	20600971200AHD	6,5 W	600 mm	3000-4000K	08618102
	20600981200AHD	7,2 W	650 mm	3000-4000K	08618103
	20600991200AHD	9,1 W	800 mm	3000-4000K	08618104
	20601001200AHD	10,4 W	900 mm	3000-4000K	08618105
	20601011200AHD	14,3 W	1200 mm	3000-4000K	08618106
	20601051200AHD	18,2 W	1500 mm	3000-4000K	08618107
	20601061200AHD	22,1 W	1800 mm	3000-4000K	08618108
	20601071200AHD	26 W	2100 mm	3000-4000K	08618109
	20601081200AHD	29,9 W	2400 mm	3000-4000K	08618110
	20601091200AHD	33,8 W	2700 mm	3000-4000K	08618111
	20101101200AHD	37,7 W	3000 mm	3000-4000K	08618112
LUGANO IP44 IRS DUAL BLUE 24 V					codice code
	20600951200CFB	2,6 W	300 mm	465 nm-4000K	08618120
	20600961200CFB	4,5 W	450 mm	465 nm-4000K	08618121
	20600971200CFB	6,5 W	600 mm	465 nm-4000K	08618122
	20600981200CFB	7,2 W	650 mm	465 nm-4000K	08618123
	20600991200CFB	9,1 W	800 mm	465 nm-4000K	08618124
	20601001200CFB	10,4 W	900 mm	465 nm-4000K	08618125
	20601011200CFB	14,3 W	1200 mm	465 nm-4000K	08618126
	20601051200CFB	18,2 W	1500 mm	465 nm-4000K	08618127
	20601051200CFB	22,1 W	1800 mm	465 nm-4000K	08618128
	20601071200CFB	26 W	2100 mm	465 nm-4000K	08618129
	20601081200CFB	29,9 W	2400 mm	465 nm-4000K	08618130
	20601091200CFB	33,8 W	2700 mm	465 nm-4000K	08618131
	20101101200CFB	37,7 W	3000 mm	465 nm-4000K	08618132

## TIPI DI ACCENSIONE POWER SWITCH ON TYPES

**Alimentazione basolare/Connessione diretta**  
(Vedi pag.30)  
Simple power supply/Direct connection  
(See page 30)

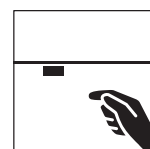

**INTERRUTTORE**  
Accensione, spegnimento e regolazione colore

Switch On/Off and colour dimming



**EMOTION DUAL COLOR**  
La temperatura colore varia da bianco "caldo" a "naturale" (3000-4000K).  
The colour temperature varies from "warm" to "natural" white (3000-4000K).

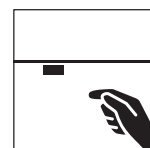

**INTERRUTTORE**  
Accensione, spegnimento e regolazione colore

Switch On/Off and colour dimming



**DUAL BLUE**  
Sorgente a doppia emissione bianco naturale 4000K e antibatterico Blue Light 465 nm (attiva per 2 ore).  
Vedi pag.40  
Light source with switchable emission Natural White 4000K and antimicrobial Blue Light 465 nm (operative for 2 hours). See page 40



# KITON

## Interno base, cestone e pensile anta battente

Kiton è un profilo lineare in alluminio con emissione luminosa direzionata sia verso l'interno che verso l'esterno. Installabile a superficie tramite clip (incluse), trova applicazione per l'illuminazione dell'interno dei mobili: la versione con sensore IR integrato ne consente l'accensione e lo spegnimento all'apertura e chiusura dell'anta. La sorgente LED Emotion Dual Color permette la variazione da 3000K a 4000K.

## Inside base unit, deep drawer and wall unit with door

Kiton is a linear aluminium profile with light emission directed both inwards and outwards. Surface mountable with clips (included), it is used to light the inside of the units: the version with integrated IR sensor allows it to be switched on and off when the door is opened and closed. The LED source Emotion Dual Color colour temperature which allows the variation from 3000K to 4000K.

H [cm]	Natural 4000K	EDC 4000K
30	900 lx	980 lx
50	400 lx	430 lx
100	125 lx	135 lx

900 mm  
468 lm  
45 lm/W  
CRI>80

# KITON - PER INTERNO BASE, CESTONE E PENSILE ANTA BATTENTE

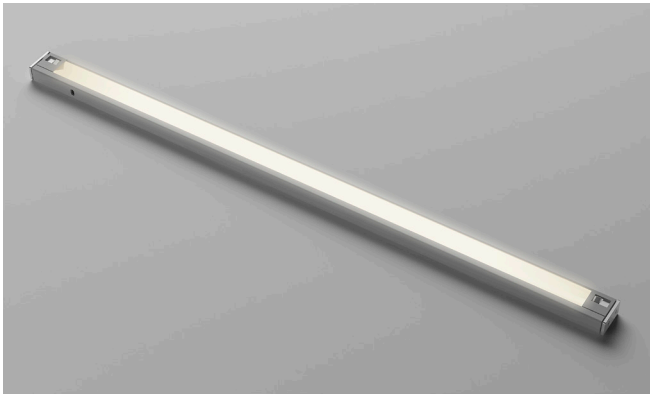
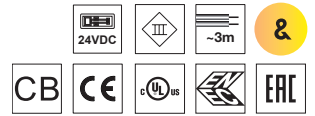

Alluminio anodizzato



Simulazione di applicazione Kiton con Dual Blue su interno cestone (attiva per 2 ore)  
Kiton simulation on internal deep drawer with Dual Blue (operative for 2 hours)

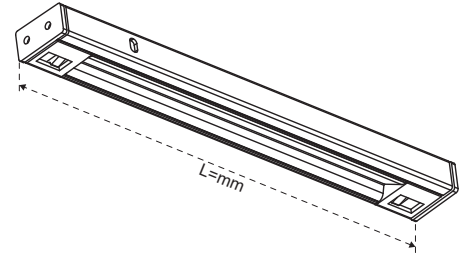
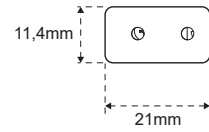

## TIPI DI ACCENSIONE POWER SWITCH ON TYPES

**Alimentazione basilare/Connessione diretta**  
(Vedi pag.30)  
Simple power supply/Direct connection  
(See page 30)

KITON IRD EDC 24 V							codice code
	26801411200AED	2,6 W	263 mm	3000-4000K	(L 300 mm)		08618140
	26801421200AED	5,2 W	413 mm	3000-4000K	(L 450 mm)		08618142
	26801431200AED	6,5 W	563 mm	3000-4000K	(L 600 mm)		08618144
	26801441200AED	7,2 W	613 mm	3000-4000K	(L 650 mm)		08618146
	26801451200AED	9,1 W	763 mm	3000-4000K	(L 800 mm)		08618148
	26801461200AED	10,4 W	863 mm	3000-4000K	(L 900 mm)		08618150
	26801471200AED	14,3 W	1163 mm	3000-4000K	(L 1200 mm)		08618152

KITON IRD DUAL BLUE 24 V							codice code
	26801411200CGB	2,6 W	263 mm	465 nm-4000K	(L 300 mm)		08618160
	26801421200CGB	4,6 W	413 mm	465 nm-4000K	(L 450 mm)		08618162
	26801431200CGB	6,5 W	563 mm	465 nm-4000K	(L 600 mm)		08618164
	26801441200CGB	7,2 W	613 mm	465 nm-4000K	(L 650 mm)		08618166
	26801451200CGB	9,1 W	763 mm	465 nm-4000K	(L 800 mm)		08618168
	26801461200CGB	10,4 W	863 mm	465 nm-4000K	(L 900 mm)		08618170
	26801471200CGB	14,3 W	1163 mm	465 nm-4000K	(L 1200 mm)		08618172

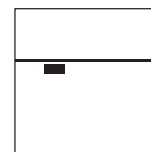

**IRS SENSOR**  
Accensione all'apertura  
Switch On opening



**EMOTION DUAL COLOR**  
La temperatura colore varia da bianco "caldo" a "naturale" (3000-4000K).  
The colour temperature varies from "warm" to "natural" white (3000-4000K).

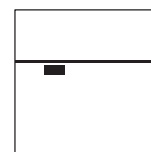

**IRS SENSOR**  
Accensione all'apertura  
Switch On opening



**DUAL BLUE**  
Sorgente a doppia emissione bianco naturale 4000K e antibatterico Blue Light 465 nm (attiva per 2 ore).  
Vedi pag.40  
Light source with switchable emission Natural White 4000K and antimicrobial Blue Light 465 nm (operative for 2 hours). See page 40



# KENDO

## Sottopensile, interno pensile/colonna o sotto mensola

Kendo è un profilo lineare da incasso in policarbonato opalino, disponibile in versione con sottile flangia sporgente o ad incasso totale (versione Kendo.IN). La sorgente LED Emotion Dual Color permette la variazione da 3000K a 4000K garantendo un comfort visivo ottimale. La versione con sensore IR Switch di prossimità integrato consente l'accensione e la variazione di temperatura. Le clip per installazione su fresata sono incluse nella confezione.

## Under wall unit, inside wall unit/column or under shelf

Kendo is a linear recessed profile in opaline polycarbonate, available in a version with a thin flange or fully recessed (Kendo.IN version). The LED source Emotion Dual Color colour temperature which allows the variation from 3000K to 4000K for optimal visual comfort. The version with integrated IR proximity switch allows ignition and temperature variation. Clips for recessed installation are included in the package.

H [cm]		
30	825 lx	900 lx
50	390 lx	425 lx
100	125 lx	135 lx

760 mm  
364 lm  
40 lm/W  
CRI>80

# KENDO EDC 24 V - PER MENSOLE

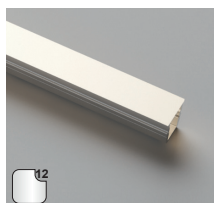
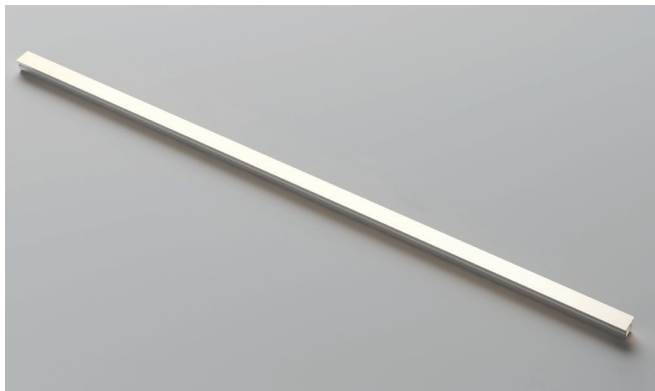

Alluminio anodizzato

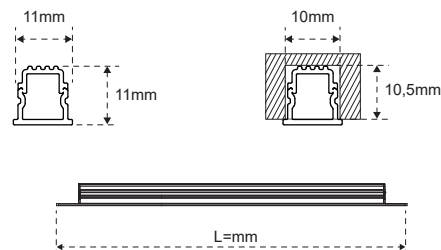
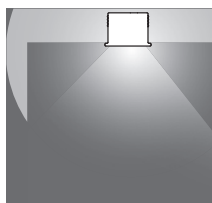

## TIPI DI ACCENSIONE POWER SWITCH ON TYPES

**Alimentazione basilare/Connessione diretta**  
(Vedi pag.30)  
Simple power supply/Direct connection  
(See page 30)

**Accensione con telecomando (1 zona)**  
(Vedi pag.32)  
Switch on with remote control (1 area)  
(See page 32)

**Accensione con app "BlueSmart" o telecomando (4 zone)**  
(Vedi pag.33)  
Switch on with "BlueSmart" app or remote control (4 areas)  
(See page 33)

KENDO PER MENSOLE						codice code
	24902460100AED	2,6 W	260 mm	3000-4000K	(L 300 mm)	08618230
	24902470100AED	4,6 W	410 mm	3000-4000K	(L 450 mm)	08618231
	24902480100AED	6,5 W	560 mm	3000-4000K	(L 600 mm)	08618232
	24902490100AED	10,4 W	860 mm	3000-4000K	(L 900 mm)	08618233
	24902500100AED	14,3 W	1160 mm	3000-4000K	(L 1200 mm)	08618234
	24902510100AED	18,2 W	1460 mm	3000-4000K	(L 1500 mm)	08618235
	24902520100AED	22,1 W	1760 mm	3000-4000K	(L 1800 mm)	08618236
	24902530100AED	26,0 W	2060 mm	3000-4000K	(L 2100 mm)	08618237
	24902540100AED	29,9 W	2360 mm	3000-4000K	(L 2400 mm)	08618238
	24902550100AED	33,8 W	2660 mm	3000-4000K	(L 2700 mm)	08618239
	24902560100AED	37,7 W	2960 mm	3000-4000K	(L 3000 mm)	08618240



**EMOTION DUAL COLOR**  
La temperatura colore varia da bianco "caldo" a "naturale" (3000-4000K) variabile tramite telecomando o cambio spinotto cavo

The colour temperature varies from "warm" to "natural" white (3000-4000K) variable via remote control or cable plug change

# KENDO IN EDC 24 V

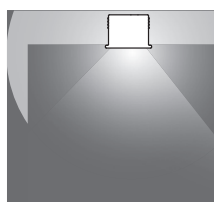
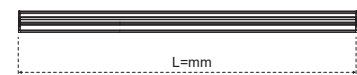
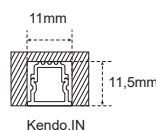
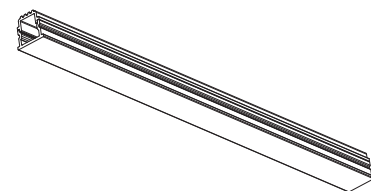

Alluminio anodizzato

## KENDO IN PER CIELO E FONDO PENSILI

						codice code
	26100630100AED	2,6 W	263 mm	3000-4000K	(L 300 mm)	08618201
	26100640100AED	4,6 W	413 mm	3000-4000K	(L 450 mm)	08618202
	26100650100AED	6,5 W	563 mm	3000-4000K	(L 600 mm)	08618203
	26100660100AED	7,2 W	613 mm	3000-4000K	(L 650 mm)	08618204
	26100670100AED	9,8 W	763 mm	3000-4000K	(L 800 mm)	08618205
	26100680100AED	10,4 W	863 mm	3000-4000K	(L 900 mm)	08618206
	26100690100AED	14,3 W	1163 mm	3000-4000K	(L 1200 mm)	08618207

## KENDO IN PER FIANCHI PENSILI/COLONNE 1 VANO

						codice code
	26100770100AED	3,9 W	323 mm	3000-4000K	(H 360 mm)	08618250
	26100780100AED	5,2 W	443 mm	3000-4000K	(H 480 mm)	08618251
	26100790100AED	7,2 W	563 mm	3000-4000K	(H 600 mm)	08618252
	26100800100AED	8,5 W	683 mm	3000-4000K	(H 720 mm)	08618253
	26100810100AED	11,7 W	923 mm	3000-4000K	(H 960 mm)	08618254
	26100820100AED	13 W	1043 mm	3000-4000K	(H 1080 mm)	08618255
	26100830100AED	15 W	1163 mm	3000-4000K	(H 1200 mm)	08618256
	26100840100AED	16,3 W	1283 mm	3000-4000K	(H 1320 mm)	08618257
	26100850100AED	18,2 W	1403 mm	3000-4000K	(H 1440 mm)	08618258
	26100860100AED	26 W	2003 mm	3000-4000K	(H 2040 mm)	08618259
	26100870100AED	27,3 W	2123 mm	3000-4000K	(H 2160 mm)	08618260
	26100880100AED	28,6 W	2243 mm	3000-4000K	(H 2280 mm)	08618261

## KENDO IN PER FIANCHI COLONNE 2 VANI

						codice code
	24902570100AED	8,5 W	693 mm	3000-4000K	(H 720 mm)	08618263
	24902580100AED	9,8 W	813 mm	3000-4000K	(H 840 mm)	08618265
	24902980100AED	11,7 W	933 mm	3000-4000K	(H 960 mm)	08618266
	24902590100AED	16,3 W	1293 mm	3000-4000K	(H 1320 mm)	08618267
	26100930100AED	18,2 W	1413 mm	3000-4000K	(H 1450 mm)	08618268
	24902600100AED	19,5 W	1533 mm	3000-4000K	(H 1560 mm)	08618269

### TIPI DI ACCENSIONE POWER SWITCH ON TYPES

**Accensione con sensore all'apertura dell'anta**  
(Vedi pag.31)  
Switch on with sensor on the door opening  
(See page 31)

**Accensione con telecomando (1 zona)**  
(Vedi pag.32)  
Switch on with remote control (1 area)  
(See page 32)

**Accensione con app "BlueSmart" o telecomando (4 zone)**  
(Vedi pag.33)  
Switch on with "BlueSmart" app or remote control (4 areas)  
(See page 33)



### EMOTION DUAL COLOR

La temperatura colore varia da bianco "caldo" a "naturale" (3000-4000K) variabile tramite telecomando o cambio spinotto cavo  
The colour temperature varies from "warm" to "natural" white (3000-4000K) variable via remote control or cable plug change

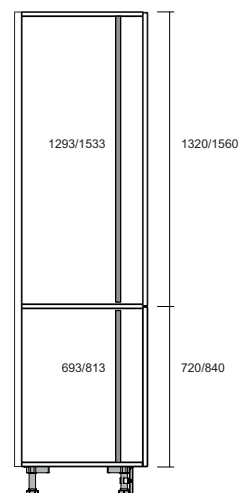

Schema fianchi colonne 2 vani  
2 compartment column sides diagram



# KENDO IN IRS EDC 24 V

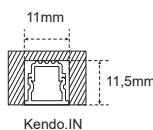
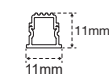

Kendo.IN

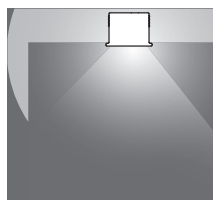
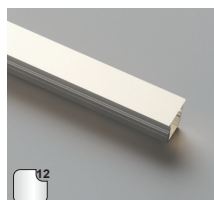
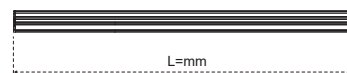
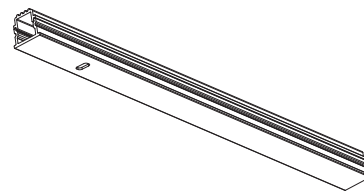

Alluminio anodizzato

## TIPI DI ACCENSIONE POWER SWITCH ON TYPES

**Alimentazione basolare/Connessione diretta**  
(Vedi pag.30)  
Simple power supply/Direct connection  
(See page 30)

KENDO IN IRS SOTTOPENSILI						codice code
	26100700100AED	2,6 W	263 mm	3000-4000K	(L 300 mm)	08618211
	26100710100AED	5,2 W	413 mm	3000-4000K	(L 450 mm)	08618212
	26100720100AED	6,5 W	563 mm	3000-4000K	(L 600 mm)	08618213
	26100730100AED	7,2 W	613 mm	3000-4000K	(L 650 mm)	08618214
	26100740100AED	9,8 W	763 mm	3000-4000K	(L 800 mm)	08618215
	26100750100AED	10,4 W	863 mm	3000-4000K	(L 900 mm)	08618216
	26100760100AED	14,3 W	1163 mm	3000-4000K	(L 1200 mm)	08618217

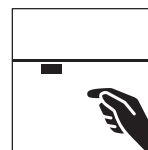

**INTERRUTTORE**  
Accensione, spegnimento e  
regolazione colore

Switch On/Off and colour  
dimming



**EMOTION DUAL COLOR**  
La temperatura colore varia  
da bianco "caldo" a "naturale"  
(3000-4000K).  
The colour temperature varies  
from "warm" to "natural" white  
(3000-4000K).



## VIVARA 8

### Ripiani vetro

Profilo in alluminio estruso che garantisce la dissipazione del calore.  
 Serie collegamento disponibile a 24 Vdc.  
 Distribuzione della luce a 180° su/giù allo stesso tempo. Adatto per il fissaggio a vetro sp.8 mm. Modulo LED dell'unità con possibilità di personalizzazione 3000K/4000K per la scelta.

**N.B.:** la luce viene diffusa solo sullo schienale ma non sullo spessore del ripiano in vetro

### Glass shelves

Extruded aluminium profile providing heat dissipation.  
 Series connection available at 12 Vdc.  
 180° degrees light distribution front and up/down at the same time.  
 Suitable for glass fixing with thickness 8 mm.  
 Unit LED module giving possibility of customization 3000K/4000K for choice.

**Note:** the light is diffused only on the back panel but not on the thickness of the glass shelf

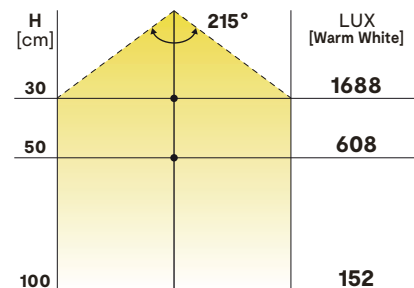

860 mm  
 569 lm  
 76 lm/W  
 CRI>80

# VIVARA 8 - PER RIPIANI VETRO

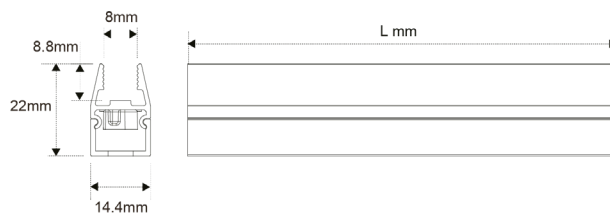
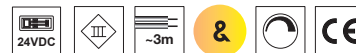

Alluminio anodizzato

## TIPI DI ACCENSIONE POWER SWITCH ON TYPES

**Alimentazione basilare/Connessione diretta**  
(Vedi pag.30)  
Simple power supply/Direct connection  
(See page 30)

**Accensione con sensore all'apertura dell'anta**  
(Vedi pag.31)  
Switch on with sensor on the door opening  
(See page 31)

**Accensione con telecomando (1 zona)**  
(Vedi pag.32)  
Switch on with remote control (1 area)  
(See page 32)

**Accensione con app "BlueSmart" o telecomando (4 zone)**  
(Vedi pag.33)  
Switch on with "BlueSmart" app or remote control (4 areas)  
(See page 33)

## VIVARA 8

						codice code
	91500011200AED	1,3 W	107 mm	3000-4000K	(L 150 mm)	08618350
	91500021200AED	3,3 W	257 mm	3000-4000K	(L 300 mm)	08618351
	91500031200AED	4,6 W	357 mm	3000-4000K	(L 400 mm)	08618352
	91500041200AED	5,2 W	407 mm	3000-4000K	(L 450 mm)	08618353
	91500051200AED	7,2 W	557 mm	3000-4000K	(L 600 mm)	08618354
	91500061200AED	7,8 W	607 mm	3000-4000K	(L 650 mm)	08618355
	91500071200AED	9,8 W	757 mm	3000-4000K	(L 800 mm)	08618356
	91500081200AED	11,1 W	857 mm	3000-4000K	(L 900 mm)	08618357
	91500111200AED	14,3 W	1157 mm	3000-4000K	(L 1200 mm)	08618358
	91500211200AED	4,6 W	277 mm	3000-4000K	(L 300 mm)	08618361
	91500221200AED	10,4 W	427 mm	3000-4000K	(L 450 mm)	08618363



## EMOTION DUAL COLOR

La temperatura colore varia da bianco "caldo" a "naturale" (3000-4000K) variabile tramite telecomando o cambio spinotto cavo. The colour temperature varies from "warm" to "natural" white (3000-4000K) variable via remote control or cable plug change.

(per elemento a giorno "CLASS" L 30)  
(for open unit "CLASS" W 30)  
(per elemento a giorno "CLASS" L 45)  
(for open unit "CLASS" W 45)



# SUNRISE 58

## Incasso

Sunrise 58 è un faretto ad incasso in alluminio con diffusore in policarbonato opalino. Proposto in tre finiture, trova applicazione come sottopensile, dove può essere installato ad incasso. La sorgente LED Emotion Dual Color permette la variazione da 3000K a 4000K.

## Recessed

Sunrise 58 is a recessed aluminium spotlight with opal polycarbonate diffuser. Available in three finishes, it can be used as an under wall unit, where it can be installed recessed. The LED source Emotion Dual Color colour temperature which allows the variation from 3000K to 4000K.

H [cm]	60°	Natural 4000K	EDC 4000K
30		1400 lx	1400 lx
50		470 lx	470 lx
100		130 lx	130 lx

332 lm  
84 lm/W  
CRI>80

# SUNRISE 58

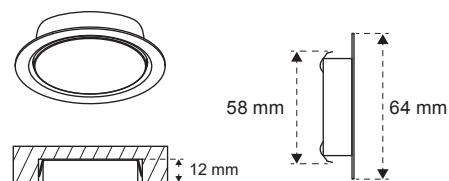
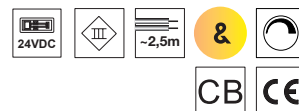

65  
Metallic grey



91  
Acciaio spazzolato

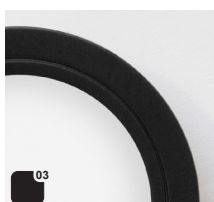

03  
Nero

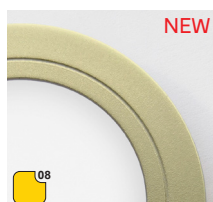

08  
Oro

## TIPI DI ACCENSIONE POWER SWITCH ON TYPES

**Alimentazione basolare/Connessione diretta**  
(Vedi pag.30)  
Simple power supply/Direct connection  
(See page 30)

**Accensione con sensore all'apertura dell'anta**  
(Vedi pag.31)  
Switch on with sensor on the door opening  
(See page 31)

**Accensione con telecomando (1 zona)**  
(Vedi pag.32)  
Switch on with remote control (1 area)  
(See page 32)

**Accensione con app "BlueSmart" o telecomando (4 zone)**  
(Vedi pag.33)  
Switch on with "BlueSmart" app or remote control (4 areas)  
(See page 33)

### SUNRISE 58 EDC 24 V

	28100046500ZD	4 W	Ø 58 mm	3000-4000K
	28100049100ZD	4 W	Ø 58 mm	3000-4000K
	28100040300ZD	4 W	Ø 58 mm	3000-4000K
	28100010800ZD	4 W	Ø 58 mm	3000-4000K

### codice code

08618082
08618081
08618080
08618083



### EMOTION DUAL COLOR

La temperatura colore varia da bianco "caldo" a "naturale" (3000-4000K) variabile tramite telecomando o cambio spinotto cavo. The colour temperature varies from "warm" to "natural" white (3000-4000K) variable via remote control or cable plug change.



**N.B.: nella versione sottotop utilizzare esclusivamente per i modelli con gola e nel fondo base.**

**Nel caso di presenza di lavastoviglie, attenersi alla tabella pag. 25 per verificare la continuità o eventuale interruzione del profilo.**

**Note: use the under-worktop version only for the models with finger rail and in the bottom base.**

**If there is a dishwasher, refer to the chart on page 25 to check the continuity or eventual interruption of the profile.**

## STRIP REEL

### Superficie

Strip Reel è una linea di circuiti stampati flessibili adatti per l'illuminazione decorativa. Fornite in rotelle sezionabili, sono disponibili a 24 V e con temperatura di colore Emotion Dual Color che permette la variazione da 3000K a 4000K.

### Surface

Strip Reel is a line of flexible printed circuit boards suitable for decorative lighting. Supplied sectionable coils, they are available in 24 V and with Dual Color Emotion colour temperature that allows the variation from 3000K to 4000K.

# LED STRIP 24 V

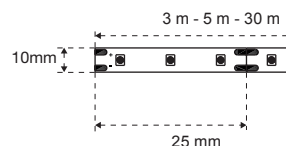
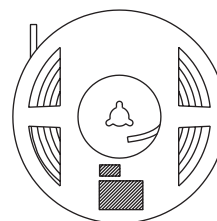
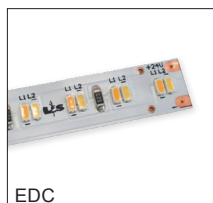
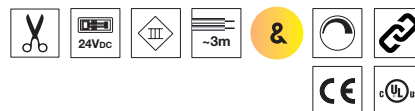

LED STRIP 24 V EDC 120 + 120 LED/M			
12810220000AHD	13 W/m	3 m	3000-4000K
12808860001AHD	13 W/m	5 m	3000-4000K
12809900000AHD	13 W/m	30 m	3000-4000K

codice code
08618053
08618055
08618059

## TIPI DI ACCENSIONE POWER SWITCH ON TYPES

**Alimentazione basilare/Connessione diretta**  
(Vedi pag.30)  
Simple power supply/Direct connection  
(See page 30)

**Accensione con sensore all'apertura dell'anta**  
(Vedi pag.31)  
Switch on with sensor on the door opening  
(See page 31)

**Accensione con telecomando (1 zona)**  
(Vedi pag.32)  
Switch on with remote control (1 area)  
(See page 32)

**Accensione con app "BlueSmart" o telecomando (4 zone)**  
(Vedi pag.33)  
Switch on with "BlueSmart" app or remote control (4 areas)  
(See page 33)

CABLES 24 V			codice code
	<p>Obbligatorio per ogni segmento montato singolarmente Required for each segment installed individually</p> <p>12603920000</p>	<p>Cavo di alimentazione da lampada ad alimentatore Connection cord from lamp to driver</p> <p>3 m</p>	08618022
	<p>12603930000</p>	<p>Prolunga da lampada a lampada N.B.: da inserire per composizione angolare Extension cord from lamp to lamp Note: to be entered for angular composition</p> <p>10 cm</p>	08618023
	<p>Necessario per composizioni superiori a 5 metri lineari Necessary for compositions over 5 meters linear</p> <p>19700450100</p>	<p>Connettore ponte per spezzoni di strip Bridge link strip connector</p>	08618024



**EMOTION DUAL COLOR**  
La temperatura colore varia da bianco "caldo" a "naturale" (3000-4000K) variabile tramite telecomando o cambio spinotto cavo  
The colour temperature varies from "warm" to "natural" white (3000-4000K) variable via remote control or cable plug change



molla inclusa (2pz)  
spring included (2pc)



molla inclusa (2pz)  
spring included (2pc)



LUCE NATURALE - NATURAL LIGHT



LUCE CALDA - WARM LIGHT



# PIASTRA LAVASTOVIGLIE PER PASSAGGIO STRISCIA LED

## DISHWASHER METAL PLATE FOR LED STRIP PASSAGE

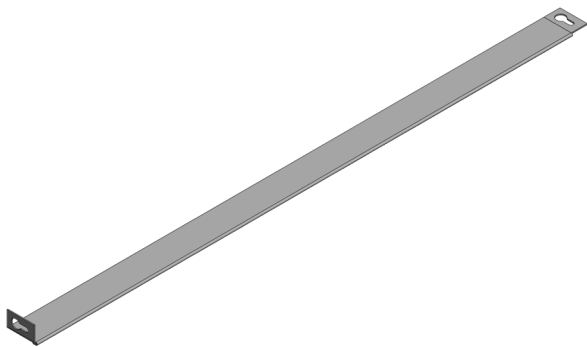

PIASTRINA PER LAVASTOVIGLIE CON PIEGA  
DISHWASHER METAL PLATE WITH FOLD

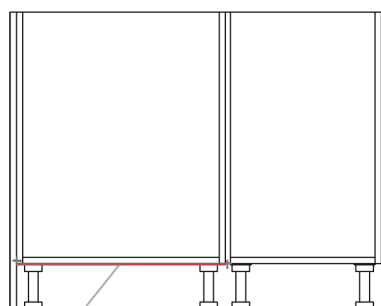

PIASTRA DA ANCORARE AL FONDO DELLA LAVASTOVIGLIE PER FISSAGGIO BARRA LED IN PROSSIMITA' DI FIANCHI DI FINITURA

Metal plate to be anchored to the bottom of the dishwasher to fix the LED strip near the finishing side panels

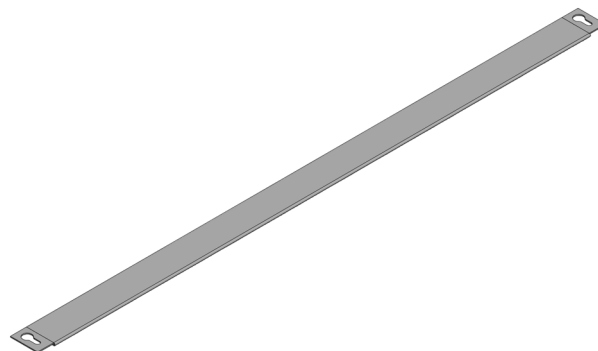

PIASTRINA PER LAVASTOVIGLIE  
DISHWASHER METAL PLATE

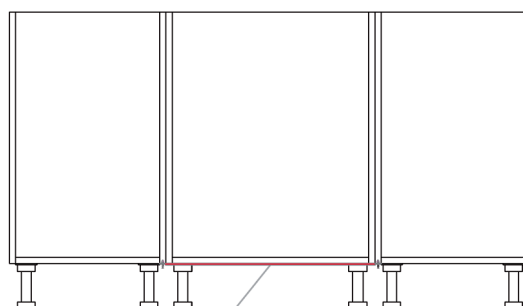

PIASTRA DA ANCORARE AL FONDO DELLA LAVASTOVIGLIE PER FISSAGGIO BARRA LED IN PROSSIMITA' DI BASI

Metal plate to be anchored to the bottom of the dishwasher to fix the LED strip near the base units

SCHEMA DI MONTAGGIO  
INSTALLATION DIAGRAM

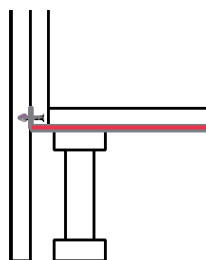

PARTICOLARE PIASTRA CON PIEGA TERMINALE  
DETAIL OF THE METAL PLATE WITH FOLD

SCHEMA DI MONTAGGIO  
INSTALLATION DIAGRAM

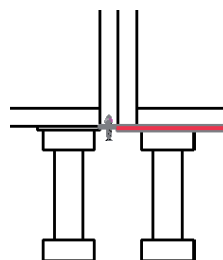

PARTICOLARE PIASTRA  
DETAIL OF THE METAL PLATE

MODULISTICA	INSERIBILE	NON INSERIBILE
SISTEMA BRIDGE PIEDI H 13/15	TIPOLOGIA SLIDING E FULCRO VARIABILE	N'EI MARCHI BOSCH SIEMENS E SAMSUNG
SISTEMA BRIDGE PIEDI H 6	<b>INSERIBILE</b>	<b>NON INSERIBILE</b>
	TUTTE LE TIPOLOGIE CON ANTA + FASCIA FISSA	TIPOLOGIA SLIDING
SISTEMA GOLA PIEDI H 13	<b>INSERIBILE</b>	<b>NON INSERIBILE</b>
	TIPOLOGIA SLIDING E FULCRO VARIABILE	NEI MARCHI BOSCH SIEMENS SAMSUNG E NELLA TIPOLOGIA ESTETICA DUE CESTI
SISTEMA GOLA PIEDI H 6	<b>INSERIBILE</b>	<b>NON INSERIBILE</b>
	TUTTE LE TIPOLOGIE CON ANTA + FASCIA FISSA	TIPOLOGIA SLIDING

MODULES	WORKING	NOT WORKING
BRIDGE SYSTEM H 13/15 FEET	SLIDING AND VARIABLE FULCRUM MODELS	BOSCH, SIEMENS AND SAMSUNG MODELS
BRIDGE SYSTEM H 6 FEET	<b>WORKING</b>	<b>NOT WORKING</b>
	ALL THE MODELS WITH DOOR + FIXED BAND	SLIDING MODELS
FINGER RAIL SYSTEM H 13 FEET	<b>WORKING</b>	<b>NOT WORKING</b>
	SLIDING AND VARIABLE FULCRUM MODELS	IN THE BOSCH, SIEMENS AND SAMSUNG MODELS - IN THE MODELS WITH TWO BASKETS
FINGER RAIL SYSTEM H 6 FEET	<b>WORKING</b>	<b>NOT WORKING</b>
	ALL THE MODELS WITH DOOR + FIXED BAND	SLIDING MODELS

Codice	Descrizione	
08617204	piastra in metallo per lavastoviglie L 45 metal plate for dishwasher W 45	

Codice	Descrizione	
08617206	piastra in metallo per lavastoviglie L 60 metal plate for dishwasher W 60	



**N.B.: LED AD USO ESCLUSIVO PER RIPIANI LIBRERIE A SPALLA SP. 25 MM E RIPIANI LEGNO MOBILI**  
**NOTE: LEDS TO BE USED EXCLUSIVELY FOR TH. 25 MM SHELVES OF BOOKCASES WITH FINISHING SIDES AND WOODEN SHELVES**

## SIRENUSE EDC

### Ripiani librerie a spalla e ripiani legno mobili

Profilo lineare in alluminio e policarbonato adatto per il montaggio sul retro della mensola in legno.

La sua forma particolare consente una distribuzione della luce a 180°, con un comfort visivo ottimale

### Shelves of bookcases with finishing sides and wooden shelves

Linear profile in aluminum and polycarbonate suitable for assembly on the back of the wooden shelf.

Its particular shape allows a 180° light distribution, with optimal visual comfort

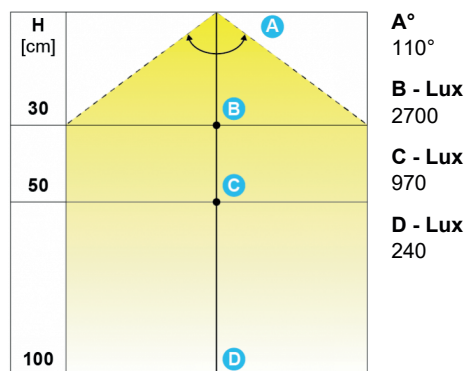

700 mm  
 650 lm  
 90 lm/W  
 CRI>80

# SIRENUSE EDC

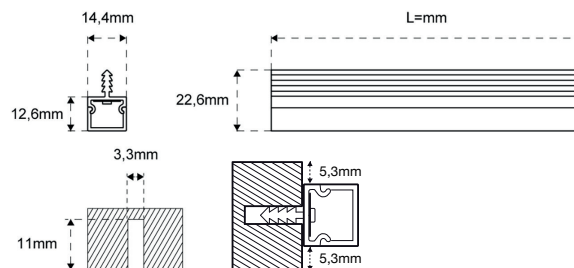
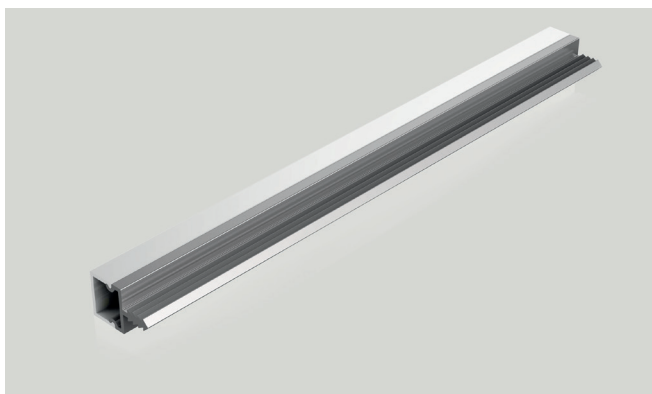
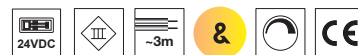

Alluminio anodizzato

## TIPI DI ACCENSIONE POWER SWITCH ON TYPES

**Alimentazione basilare/Connessione diretta**  
(Vedi pag.30)  
Simple power supply/Direct connection  
(See page 30)

**Accensione con telecomando (1 zona)**  
(Vedi pag.32)  
Switch on with remote control (1 area)  
(See page 32)

**Accensione con app "BlueSmart" o telecomando (4 zone)**  
(Vedi pag.33)  
Switch on with "BlueSmart" app or remote control (4 areas)  
(See page 33)

## SIRENUSE PER RIPIANI LIBRERIA A SPALLA

							codice code
	90500131200BED	3,4 W	275 mm	3000-4000K	(L 300 mm)		08618371
	90500141200BED	5,4 W	425 mm	3000-4000K	(L 450 mm)		08618373
	90500151200BED	7,4 W	575 mm	3000-4000K	(L 600 mm)		08618374
	90500161200BED	11,5 W	875 mm	3000-4000K	(L 900 mm)		08618377
	90500171200BED	15,5 W	1175 mm	3000-4000K	(L 1200 mm)		08618378



## EMOTION DUAL COLOR

La temperatura colore varia da bianco "caldo" a "naturale" (3000-4000K) variabile tramite telecomando o cambio spinotto cavo

The colour temperature varies from "warm" to "natural" white (3000-4000K) variable via remote control or cable plug change

## SIRENUSE PER RIPIANI IN LEGNO DEI MOBILI

							codice code
	90500391200BED	3,4 W	262 mm	3000-4000K	(L 300 mm)		08618381
	90500401200BED	4,7 W	362 mm	3000-4000K	(L 400 mm)		08618382
	90500411200BED	5,4 W	412 mm	3000-4000K	(L 450 mm)		08618383
	90500421200BED	7,4 W	562 mm	3000-4000K	(L 600 mm)		08618384
	90500431200BED	8,1 W	612 mm	3000-4000K	(L 650 mm)		08618385
	90500441200BED	9,5 W	712 mm	3000-4000K	(L 750 mm)		08618386
	90500451200BED	10,1 W	762 mm	3000-4000K	(L 800 mm)		08618387
	90500461200BED	11,5 W	862 mm	3000-4000K	(L 900 mm)		08618388
	90500471200BED	15,5 W	1162 mm	3000-4000K	(L 1200 mm)		08618389



Finitura: Alluminio



Orientamento luce: 45°



# LINEA\_8 MM

## Molteplici installazioni

Linea\_8 mm è un profilo lineare con ottica inclinata che consente l'emissione di luce diffusa ed omogenea sul piano di lavoro. L'installazione è semplice ed è tramite biadesivo, incluso nella confezione. La sorgente LED Dual Color permette la variazione da 3000K a 4000K, garantendo un comfort visivo ottimale.

Grazie alle sue dimensioni ridotte può essere installata ovunque: sottopensile, sotto la cappa e lo scolapiatti, sopra il pensile, sotto il living, ecc.

## Multiple installations

Linea\_8 mm is a linear profile with inclined optics that allows the emission of diffused and homogeneous light on the work surface. Installation is simple and using double-sided tape included in the package. The LED source Dual Color colour temperature which allows the variation from 3000K to 4000K for optimal visual comfort.

Thanks to its small size, it can be installed anywhere: under the wall unit, under the hood and plate rack, above the wall unit, under the living, etc.

LINEA_8 MM IP20 24 V				codice code
3,45 W	300 mm	3000-4000K		08617250
5,2 W	450 mm	3000-4000K		08617251
6,9 W	600 mm	3000-4000K		08617252
7,5 W	650 mm	3000-4000K		08617253
8,25 W	750 mm	3000-4000K		08617253A
9,2 W	800 mm	3000-4000K		08617254
10,4 W	900 mm	3000-4000K		08617255
13,8 W	1200 mm	3000-4000K		08617256
17,3 W	1500 mm	3000-4000K		08617257
20,7 W	1800 mm	3000-4000K		08617258
24,2 W	2100 mm	3000-4000K		08617259
27,6 W	2400 mm	3000-4000K		08617260
31,1 W	2700 mm	3000-4000K		08617261
34,5 W	3000 mm	3000-4000K		08617262

### TIPI DI ACCENSIONE POWER SWITCH ON TYPES

**Alimentazione basolare/Connessione diretta**  
(Vedi pag.30)  
Simple power supply/Direct connection  
(See page 30)

**Accensione con telecomando (1 zona)**  
(Vedi pag.32)  
Switch on with remote control (1 area)  
(See page 32)

**Accensione con app "BlueSmart" o telecomando (4 zone)**  
(Vedi pag.33)  
Switch on with "BlueSmart" app or remote control (4 areas)  
(See page 33)

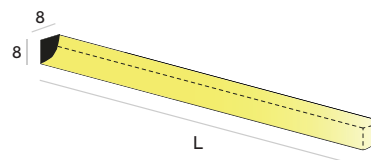

LINEA_8 MM TOUCH IP20 24 V				codice code
3,45 W	300 mm	3000-4000K		08617270
5,2 W	450 mm	3000-4000K		08617271
6,9 W	600 mm	3000-4000K		08617272
7,5 W	650 mm	3000-4000K		08617273
8,25 W	750 mm	3000-4000K		08617273A
9,2 W	800 mm	3000-4000K		08617274
10,4 W	900 mm	3000-4000K		08617275
13,8 W	1200 mm	3000-4000K		08617276
17,3 W	1500 mm	3000-4000K		08617277
20,7 W	1800 mm	3000-4000K		08617278
24,2 W	2100 mm	3000-4000K		08617279
27,6 W	2400 mm	3000-4000K		08617280
31,1 W	2700 mm	3000-4000K		08617281
34,5 W	3000 mm	3000-4000K		08617282

### TIPI DI ACCENSIONE POWER SWITCH ON TYPES

**Alimentazione basolare/Connessione diretta**  
(Vedi pag.30)  
Simple power supply/Direct connection  
(See page 30)

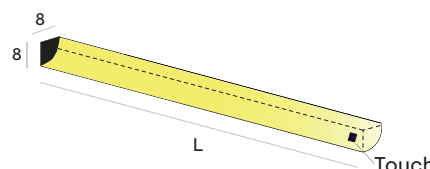

L'interruttore touch si trova sulla destra.  
Per averlo sulla sinistra basta capovolgere la barra in fase di montaggio.  
The touch switch is located on the right.  
To have it on the left, simply turn the bar upside down during assembly.

# MEC DRIVER

## 4 ALIMENTATORI IN 1, CON SISTEMI DI COMANDO INTEGRATI

Più flessibilità per connettere il futuro

## 4 POWER SOURCES IN 1, WITH INTEGRATED CONTROL SYSTEMS

Increased flexibility to connect the future

### IL "DO IT YOURSELF" DI NUOVA GENERAZIONE

#### MEC DRIVER RIVOLUZIONA IL MONDO DELL'ILLUMINAZIONE LED

Da oggi è possibile costruire in completa autonomia e con la massima semplicità un sistema di alimentazione modulare che gestisca illuminazione e domotica, già pronto e certificato per quasi tutti i mercati mondiali. Il cuore del sistema è il nuovo alimentatore multitemperatura disponibile in 6 diverse potenze (18, 36, 48, 72, 90, 120W) e componibile con tutte le principali prese. Ad esso si possono connettere i moduli per comandare a distanza ogni funzione di regolazione dell'illuminazione, del suono e della domotica. In tal modo si ottiene una soluzione di controllo completa, dall'ingombro minimo.

### NEXT GENERATION DIY

#### PROMISES TO TRANSFORM THE WORLD OF LED LIGHTING

Now you can build your own lighting and home modular automation power supply system – which has been approved for almost any global market – with incredible speed and ease of assembly. The heart of the system is the new multi-voltage power source, available in six different levels of wattage (18, 36, 48, 72, 90 and 120W) and suitable for all common socket-types. It is possible to connect the modules for remote regulation of every aspect of home lighting, sound and automation. In this way you can reach a compact and modular solution, for a complete control of all system.



#### MULTITEMPERATURA

Input: 100\240VAC Output: 24 VDC

#### MULTI-VOLTAGE

Input: 100\240VAC Output: 24 VDC



#### CERTIFICAZIONI INTERNAZIONALI

ALL LEADING INTERNATIONAL ACCREDITATIONS



#### CONTROLLO REMOTO

Via Wi-fi, Radio Frequenza (R.F.), Bluetooth, sensori via cavo

#### REMOTE CONTROL

Connection via Wi-fi, Radio Frequency (R.F.), Bluetooth, wired sensors

## ONE DRIVER ENDLESS OPTIONS

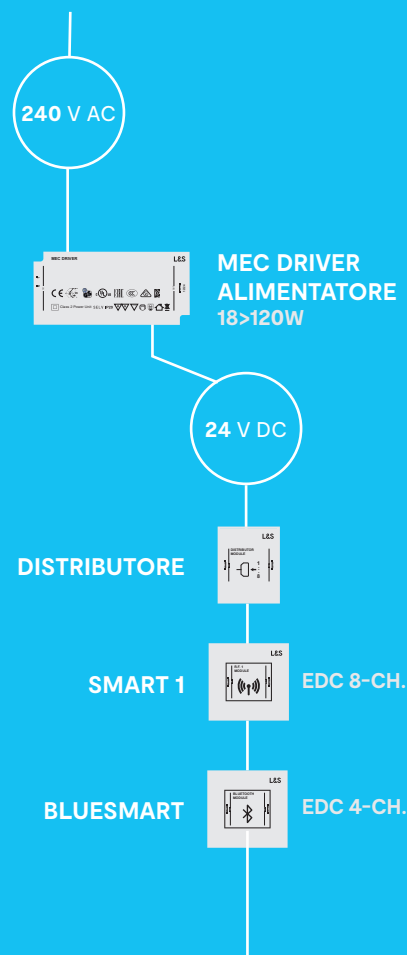

## KIT BASE

## Alimentazione basilare/Connessione diretta Basic power supply/Direct connection



### Composto da:

- 1) CAVO ALIMENTAZIONE (EU/USA/Canada)
- 2) ALIMENTATORE **in base alla potenza necessaria**
- 3) DISTRIBUTORE

### Composed of:

- 1) POWER CABLE (EU/USA/Canada)
- 2) POWER SUPPLY **according to the power request**
- 3) DISTRIBUTOR

### KIT ALIMENTAZIONE EUROPA EUROPE POWER SUPPLY KIT

KIT EUROPA	POWER	OUTPUT	codice code
12422150000	18 W	24 V DC	08618000EU
12422160000	36 W	24 V DC	08618001EU
12422170000	48 W	24 V DC	08618002EU
12422180000	72 W	24 V DC	08618003EU
12422190000	90 W	24 V DC	08618004EU
12425890000	120 W	24 V DC	08618005EU

### KIT ALIMENTAZIONE USA/CANADA USA/CANADA POWER SUPPLY KIT

KIT USA/CANADA	POWER	OUTPUT	codice code
12422070000	18 W	24 V DC	08618000UL
12422080000	36 W	24 V DC	08618001UL
12422080000	48 W	24 V DC	08618002UL
12422100000	60 W	24 V DC	08618003UL
12422580000	90 W	24 V DC	08618004UL

# Accensione con sensore all'apertura dell'anta Switch on with sensor on the door opening

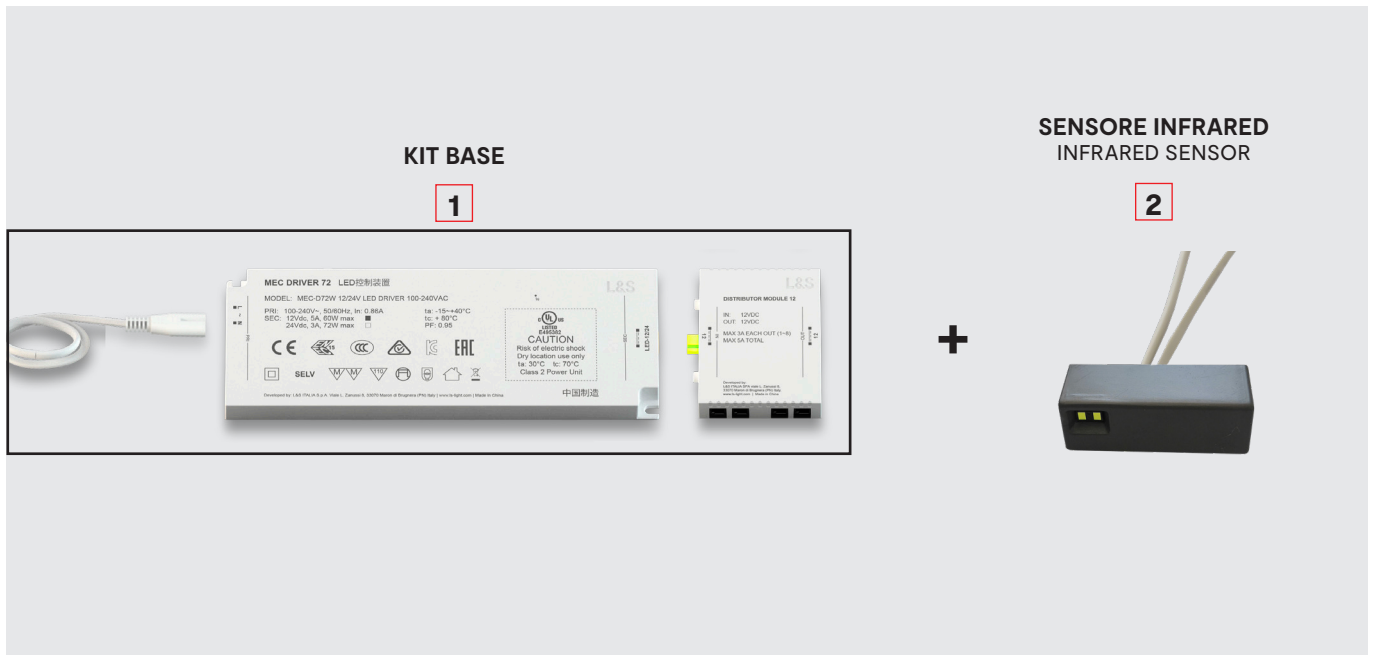

## Composto da:

- 1) KIT BASE (EUROPA o USA/Canada)
- 2) INFRARED sensore apertura anta (1 per ogni mobile)

## Composed of:

- 1) BASIC KIT (EUROPE or USA/Canada)
- 2) INFRARED sensor for open door (1 for each furniture)

## 2 SENSORE INFRARED INFRARED SENSOR



**OUTPUT:** Max carico 60 W, max 2.5 A/output

SENSORE	INPUT	DIMENSIONI	codice code
	24 V DC	12 x 34 x 12 mm	08618037

Sensore ad infrarossi per accensione e spegnimento della luce presente nel mobile.  
Installazione a superficie, disponibile in versione 24 V.

Infrared sensor for switch On/Off of the light in the unit.  
Installation available in 24 V version.

# Accensione con telecomando (1 zona) Switch on with remote control (1 area)

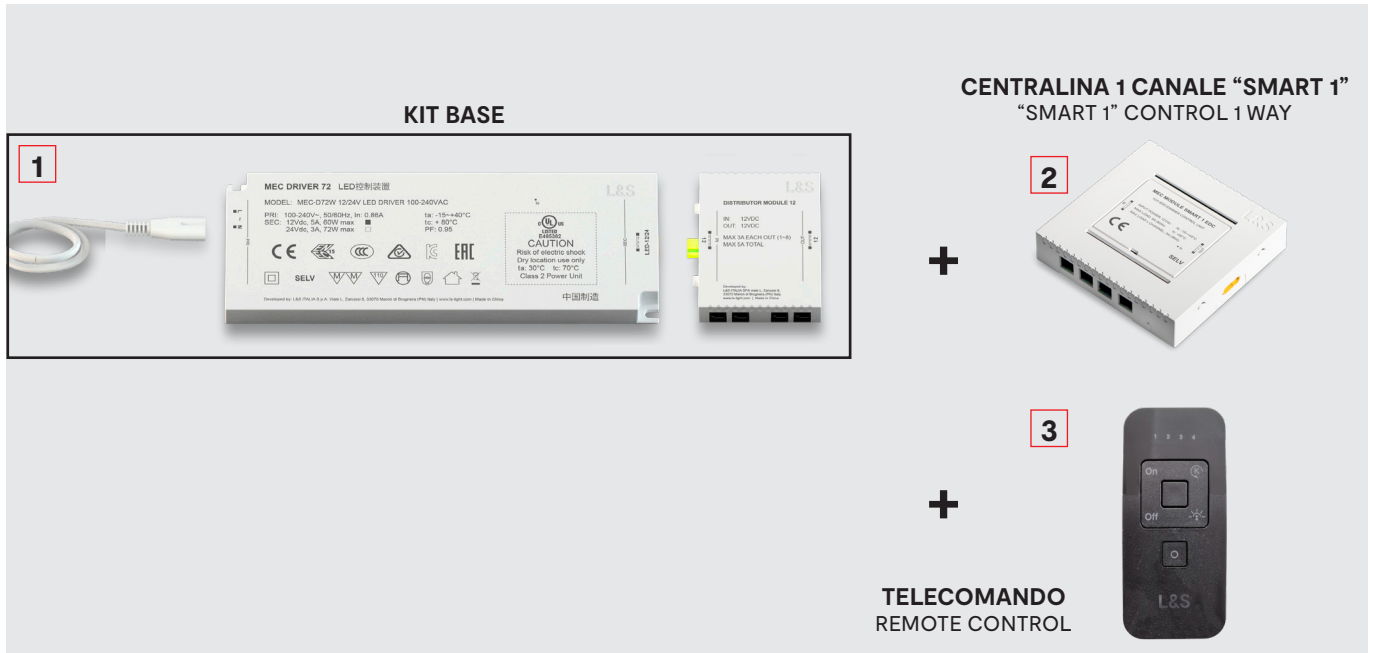

## Composto da:

- 1) KIT BASE (EUROPA o USA/Canada)
- 2) CENTRALINA 1 CANALE "SMART 1"
- 3) TELECOMANDO (da scegliere)

## Composed of:

- 1) BASIC KIT (EUROPE or USA/Canada)
- 2) "SMART 1" CONTROL 1 WAY
- 3) REMOTE CONTROL (to be selected)

## 2 CENTRALINA 1 CANALE "SMART 1" "SMART 1" CONTROL 1 WAY



OUTPUT: Max 5 A total, max 3 A/output

SMART 1	TIPO	INPUT	WAYS	codice code
24201880100	EDC	24 V DC	8	08618031

La centralina *Smart 1* consente di controllare simultaneamente fino a 8 lampade in uscita con i telecomandi della linea *Smart Up 1* e *Smart Up 4*. I moduli possono essere connessi ad altri moduli di distribuzione o di controllo purché si mantenga la stessa tensione in uscita.

The *Smart 1* control unit allows you to simultaneously control up to 8 output lamps with the *Smart Up 1* and *Smart Up 4* remote controls. The modules can be connected to other distribution or control modules as long as the same output voltage is maintained.

## 3 TELECOMANDO 4 CANALI REMOTE CONTROL 4 WAYS



### SMART UP 4

- On/Off - Dimmerazione - Gestione del colore
- 15 m portata all'interno di edifici
- Batteria CR2032 (3 anni di durata)
- On/Off - Dimming - Colour management
- 15 m range indoor
- Battery CR2032 (3 years lasting)

SMART UP 4 (4 CANALI)	TIPO	DIMENSIONI	codice code
24203250300	EDC	82x37x10	08618035



# Accensione con app "BlueSmart" o telecomando (4 zone) Switch on with "BlueSmart" app or remote control (4 areas)

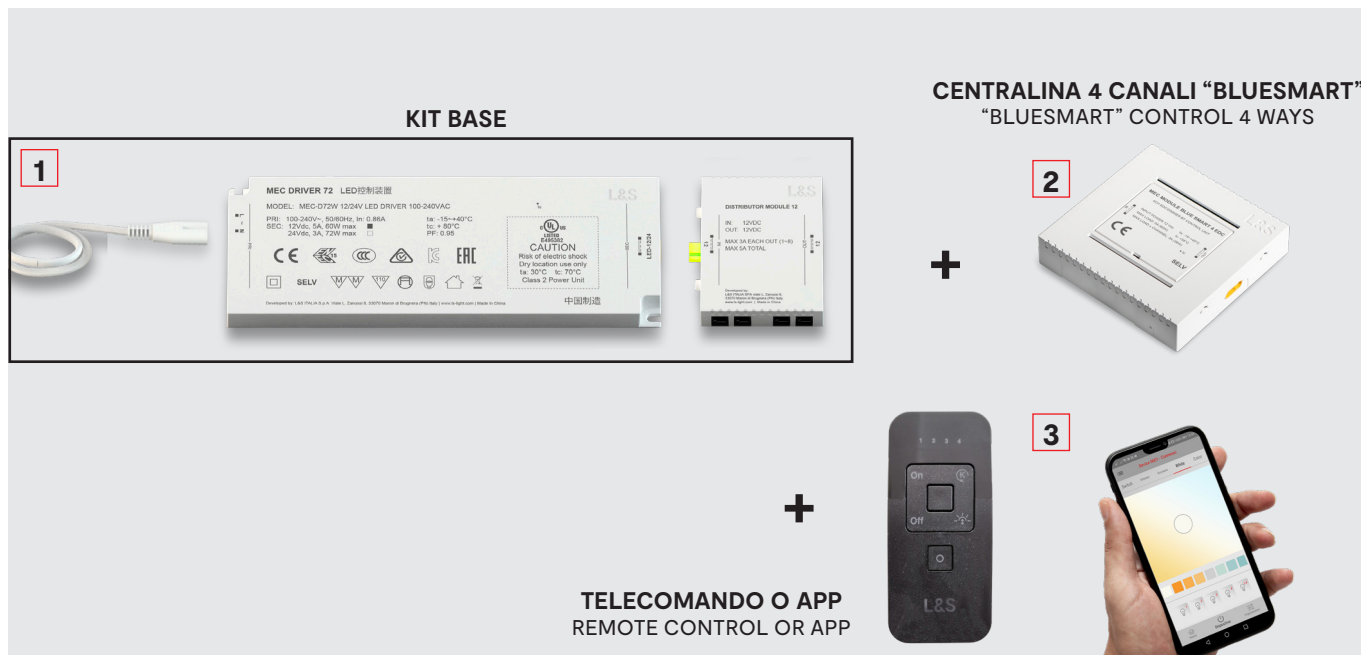

## Composto da:

- 1) KIT BASE (EUROPA o USA/Canada)
- 2) CENTRALINA 4 CANALI "BLUESMART 4" (Bluetooth)
- 3) TELECOMANDO 4 CANALI "SMART UP 4" o App "BlueSmart"

## Composed of:

- 1) BASIC KIT (EUROPE or USA/Canada)
- 2) "BLUESMART" CONTROL 4 WAYS (Bluetooth)
- 3) REMOTE CONTROL 4 WAYS "SMART UP 4" or "BlueSmart" App

## 2 CENTRALINA 4 CANALI "BLUESMART" "BLUESMART" CONTROL 4 WAYS



OUTPUT: Max 5 A total, max 3 A/output

BLUESMART	TIPO	INPUT	WAYS	codice code
24201770100	EDC	24 V DC	4	08618030

La centralina *BlueSmart* consente di controllare individualmente fino a 4 lampade in uscita tramite l'apposita app, scaricabile gratuitamente da *App Store* e *Google Play*. È inoltre compatibile con i telecomandi della linea *Smart Up 1* e *Smart Up 4*. I moduli possono essere connessi ad altri moduli di distribuzione o di controllo purché si mantenga la stessa tensione in uscita.

The *BlueSmart* control unit allows you to individually control up to 4 output lamps using the *Bluesmart* app, which can be downloaded for free from the *App Store* and *Google Play*. It is also compatible with the *Smart Up 1* and *Smart Up 4* remote controls. The modules can be connected to other distribution or control modules as long as the same output voltage is maintained.

## 3 TELECOMANDO 4 CANALI REMOTE CONTROL 4 WAYS



### SMART UP 4

- On/Off - Dimmerazione - Gestione del colore
- 15 m portata all'interno di edifici
- Batteria CR2032 (3 anni di durata)
- On/Off - Dimming - Colour management
- 15 m range indoor
- Battery CR2032 (3 years lasting)

SMART UP 4 (4 CANALI)	TIPO	DIMENSIONI	codice code
03 24203250300	EDC	82x37x10	08618035

## APP "BLUESMART" "BLUESMART" APP



Vedi spiegazioni a pagina 38.  
See explanations on page 38.



ANDROID APP ON  
Google Play



Download on the  
App Store

## MOLTIPLICATORE INGRESSI INPUT MULTIPLIER



Modalità di utilizzo  
Use modality

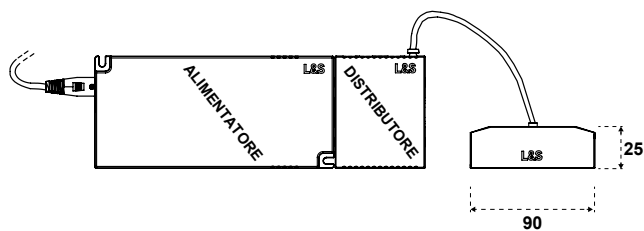

INPUT: 24 V DC

MOLTIPLICATORE	WAYS	CAVO
12606760000	10	200 mm

codice code
08618026

Il moltiplicatore di ingressi consente di collegare fino a 10 lampade per ogni ingresso del modulo. Può essere inserito su tutti i KIT.

The input multiplier allows up to 10 lamps to be connected to each input of the module. It can be inserted on all KIT.

## PROLUNGA EXTENSION



INPUT: 24 V DC

PROLUNGA	CAVO
	2000 mm

codice code
08618029

Prolunga universale per tutti i prodotti. Da utilizzare in aggiunta ai cavi standard per distanze maggiori tra alimentatore e elemento luminoso.

Universal extension cable for all products. To be used in addition to standard cables for longer distances between ballast and lighting element.

## CENTRALINA 1 CANALE “SMART 1” “SMART 1” CONTROL 1 WAY

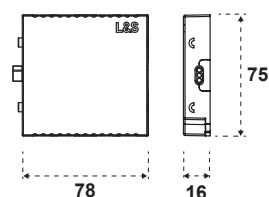

**OUTPUT:** Max 5 A total, max 3 A/output

SMART 1	TIPO	INPUT	WAYS	codice code
24201880100	EDC	24 V DC	8	08618031

La centralina *Smart 1* consente di controllare simultaneamente fino a 8 lampade in uscita con i telecomandi della linea *Smart Up 1* e *Smart Up 4*. I moduli possono essere connessi ad altri moduli di distribuzione o di controllo purché si mantenga la stessa tensione in uscita.

The Smart 1 control unit allows you to simultaneously control up to 8 output lamps with the Smart Up 1 and Smart Up 4 remote controls. The modules can be connected to other distribution or control modules as long as the same output voltage is maintained.

## CENTRALINA 4 CANALI “BLUESMART” “BLUESMART” CONTROL 4 WAYS

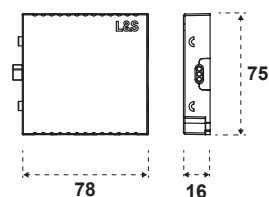

**OUTPUT:** Max 5 A total, max 3 A/output

BLUESMART	TIPO	INPUT	WAYS	codice code
24201770100	EDC	24 V DC	4	08618030

La centralina *BlueSmart* consente di controllare individualmente fino a 4 lampade in uscita tramite l'apposita app, scaricabile gratuitamente da *App Store* e *Google Play*. È inoltre compatibile con i telecomandi della linea *Smart Up 1* e *Smart Up 4*. I moduli possono essere connessi ad altri moduli di distribuzione o di controllo purché si mantenga la stessa tensione in uscita.

The BlueSmart control unit allows you to individually control up to 4 output lamps using the Bluesmart app, which can be downloaded for free from the App Store and Google Play. It is also compatible with the Smart Up 1 and Smart Up 4 remote controls. The modules can be connected to other distribution or control modules as long as the same output voltage is maintained.

## TELECOMANDO 4 CANALI "SMART UP 4"

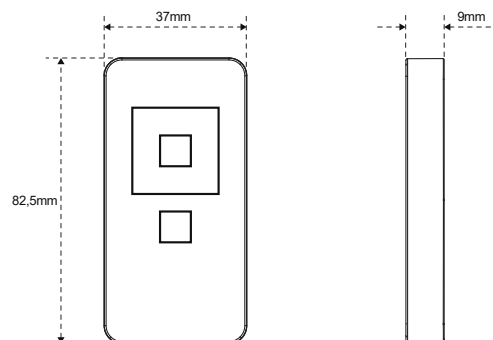

TELECOMANDO SMART UP 4 TIPO	WAYS	codice code
 24203250300	EDC	08618035
	4 ch.	

- \ On/Off - Dimmerazione - Gestione del colore
- \ 15 m portata all'interno di edifici
- \ Batteria CR2032 (3 anni di durata)

- \ On/Off - Dimming - Colour management
- \ 15 m range indoor
- \ Battery CR2032 (3 years lasting)

Telecomando wireless con possibilità di controllare e memorizzare fino a 4 canali indipendenti.

Associato alla centralina Smart 4, controlla le luci sia per funzioni di dimmerazione dell'intensità luminosa, che di cambio della temperatura colore nella versione EDC.

Wireless controller with central button, crown and touch controls, with the possibility to control and store up to 4 independent channels. Combined with the Smart 4 control, it controls the lights both for dimming the light intensity and changing the colour temperature in the EDC version.

# INTERRUTTORE PUCKY

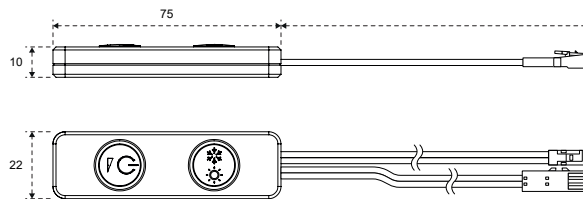

TELECOMANDO SMART UP 1	TIPO	INPUT	codice code
 12409430000	EDC	24 V DC	08618038

\ On/Of Dimmerazione - Gestione del colore  
 \ Adesivo per installazione

\ On/Of Dimming - Colour management  
 \ Installation adhesive

Interruttore con 2 pulsanti dotato di adesivo per installazione sotto pensile o su schienale. Può essere associato al Kit base (Alimentazione basilare/Connessione diretta) così da controllare le luci sia per funzioni di dimmerizzazione dell'intensità luminosa, che di cambio della temperatura colore.  
*Compatibile con i prodotti:*  
 Mini Noor, Kendo 14, Kendo IN 16, Vivara 8, Sunrise, Strip Reel, Linea\_8 mm

2 button switch with sticker for under wall unit or back panel installation. Associated with Kit base (Basic power supply/Direct connection), it controls de lights both for dimming the light intensity and for changing the colour temperature.  
*Compatible with products:*  
 Mini Noor, Kendo 14, Kendo IN 16, Vivara 8, Sunrise, Strip Reel, Linea\_8 mm



### DEVICE SETTING

Consente di visualizzare i dispositivi connessi suddivisi in zone.

Displays the connected devices divided into zones.

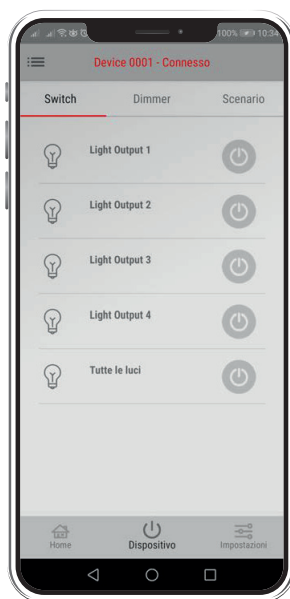

### SWITCH MODE

Consente di selezionare, accendere o spegnere le singole zone.

Allows you to select, switch on or off individual zones.

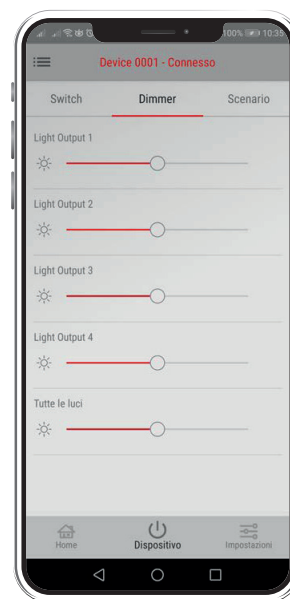

### DIMMER MODE

Consente di regolare l'intensità luminosa di ogni singola lampada.

Allows you to adjust the light intensity of each individual lamp.



### SCENARIO MODE

Consente di gestire fino a 4 diversi scenari da configurare con le impostazioni preferite.

It allows you to manage up to 4 different scenarios to configure with your preferred settings.

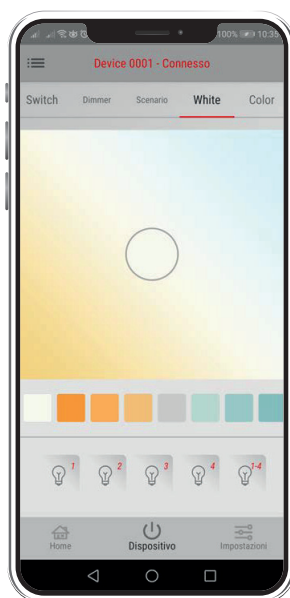

### WHITE MODE

Nelle versioni EDC, consente di selezionare la temperatura di colore di ogni singola lampada.

In the EDC versions, it allows you to select the color temperature of each individual lamp.



ANDROID APP ON  
Google Play



Download on the  
App Store

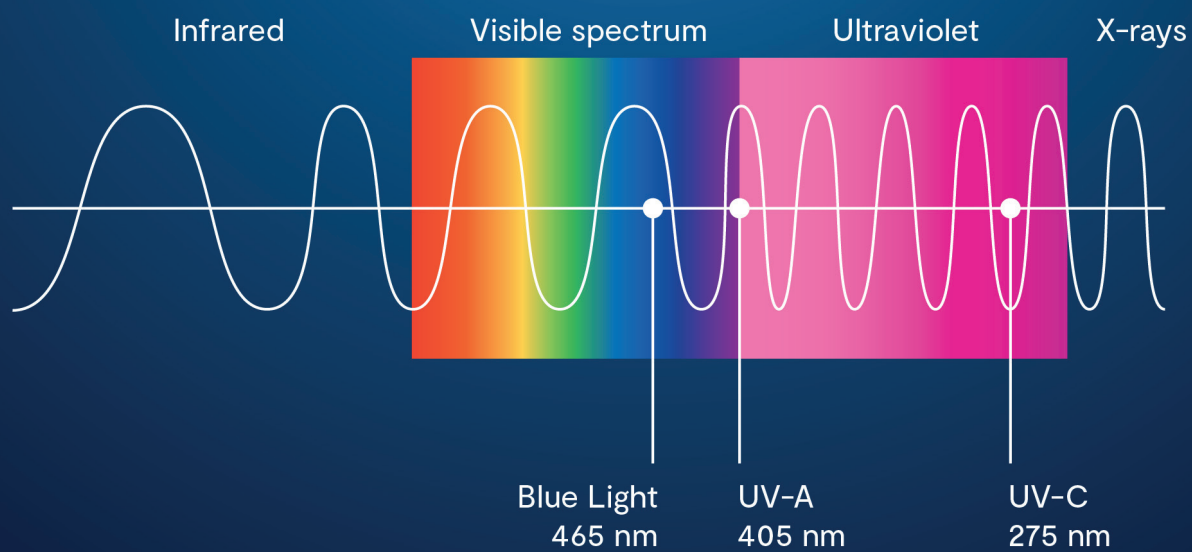

# APPLICAZIONI TIPICHE

## TYPICAL MARKET APPLICATIONS



### Dual Blue

Sorgente a doppia emissione Bianco Naturale 4000K e Blue Light 465 nm.

Light source with switchable emission Natural White 4000K and Blue Light 465 nm.

## Blue Light

465 nm

### CONTRIBUISCE ALLA RIDUZIONE DELLA CARICA MICROBICA

ATTIVA PER 2 ORE

Sicuro per le persone e per i materiali

### CONTRIBUTION TO THE MICROBIAL CHARGE REDUCTION

OPERATIVE FOR 2 HOURS

Safe for the people and for the materials

### BLUE LIGHT

Uccide i batteri  
Kill bacteria



Uccide i virus  
Kill virus



Consente la presenza di persone  
Allow people in the room



Non è dannoso per pelle e occhi  
Harmless for skin and eyes



Non danneggia le superfici  
Doesn't damage surfaces



Rimuove gli odori dai vestiti  
Remove odors from clothes



Tempo medio di efficacia  
Average time to be effective

2 ore  
2 hours



Positivo  
Positive



Non positivo  
Not positive



# SOLUZIONI DI ILLUMINAZIONE ITAL PEK

## ITAL PEK LIGHTING SOLUTIONS

■ <b>WING</b> WING	42	■ <b>GLASS_8</b> GLASS_8	56
■ <b>SLIDE</b> SLIDE	46	■ <b>SPOT_3328</b> SPOT_3328	58
■ <b>MICRO</b> MICRO	50	■ <b>ACCESSORI</b> ACCESSORIES	64
■ <b>FLUX_9</b> FLUX_9	52		

# ITAL PEK

ATELIER LED LIGHTING

#### DUAL COLOR

La temperatura colore varia da bianco "caldo" a "naturale" (3000K-4000K).

**N.B.: tutte le luci riportate a listino sono in versione Dual Color**

The colour temperature varies from "warm" to "natural" white (3000K-4000K).

**Note: all the lights included in this price list are in Dual Color version**



I nostri prodotti sono certificati UL per Stati Uniti e Canada.

# WING sottopensile / under wall unit



WING è semplice da installare grazie al fissaggio con clips a scomparsa.

Lo schermo frontale integrato nel profilo rende la luce indiretta gradevole e non invasiva nell'ambiente cucina-living. La luce è direzionata efficacemente sul piano di lavoro.

Il touch button integrato all'estremità destra accende, spegne, regola l'intensità e permette di cambiare la tonalità della luce da calda 3000K a naturale 4000K e viceversa.

*WING is easy to install thanks to its invisible fastening clips.*

*The integrated front shield makes the indirect light pleasant and non-invasive in the kitchen-living room, but at the same time efficient and well directed on the work surface.*

*The integrated touch button on the right allows you to switch the light on and off, adjusts its intensity, and change its tone from warm white 3000K to natural white 4000K.*

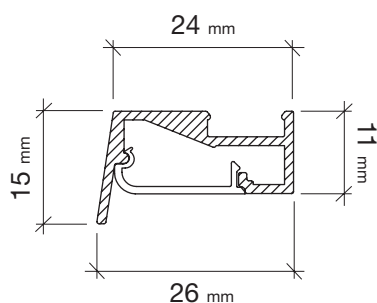

360 LED DUAL COLOR (180 +180 LED/m)

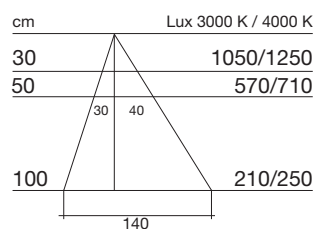

Il valore in LUX indicato è riferito ad una barra L=1200 mm  
Values in LUX refer to 1200 mm long lighting units

## Caratteristiche tecniche

profilo	grigio orione
diffusore	policarbonato opalino
fissaggio	mediante clips a scomparsa
lunghezza profilo	da 300 mm a 3000 mm
LED	180 +180 LED/m 14,4 W/m
colore luce temperatura	DUAL COLOR_3000K - 4000K
alimentazione	24V - DC
lunghezza cavo	cavetto 300 mm + cavo da 2800 mm con connettori
caratteristica	luce continua, senza interruzioni
certificazione fotobiologica	classe 0
resa cromatica	CRI>80
certificazioni	CE + UL

## Technical features

profile	orion grey
diffuser	opal polycarbonate
fastening	by means of hidden clips
profile length	from 300 mm up to 3000 mm
LED	180 +180 LED/m 14,4 W/m
colour temperature	DUAL COLOR_3000K - 4000K
power supply	24V - DC
cable length	300 mm cable + 2800 mm extension cable
light features	uniform and seamless light, with no interruptions
photobiological safety	RG (risk group) 0
chromaticity Index	CRI>80
compliance	CE + UL



### TOUCH BUTTON

Il touch button posizionato a destra funziona al rilascio del dito. A lampada spenta un piccolo LED bianco dietro il diffusore ne segnala la posizione, a lampada accesa il LED bianco si spegne.

### FUNZIONAMENTO

- 1 - toccando il touch button la lampada si accende al 100%;
- 2 - toccando di nuovo il touch button la luminosità si riduce al 50%;
- 3 - tenendo il dito sul touch button si regola l'intensità (dimmer);
- 4 - toccando il touch button la lampada si spegne.

### CAMBIO COLORE

A lampada spenta, tenendo il dito fermo sul touch LED per almeno 20 secondi, il colore della luce cambia da bianco caldo 3000K a naturale 4000K o viceversa.

Il touch button memorizza l'ultima posizione impostata. Dopo un blackout la lampada ritorna nella stessa posizione in cui si trovava prima dello spegnimento.

**Tutte le nostre lampade con touch button possono essere comandate da un interruttore esterno.**

### TOUCH BUTTON

The touch button on the right side works as a touch-and-release button. When the lighting unit is off, a white LED behind the diffuser indicates the position of the touch button. This goes off when the unit is turned on.

### FUNCTIONING

- 1 - touching the touch button light turns on at 100%;
- 2 - touching it again the brightness is reduced at 50%;
- 3 - holding the finger on the touch button light is dimmed;
- 4 - touching the touch button light turns off.

### LED COLOUR CHANGE

With the light off, hold a finger on the touch button for at least 20 seconds. LED colour temperature changes from 3000K (warm) to 4000K (natural) and viceversa.

The touch button saves the last position set. After a power cut, the light returns to the same position as it had been set before the power outage.

**All our lighting units with touch button can be turned on and off via an external switch.**

# WING sottopensile / under wall unit



Foro per passaggio cavo diam. 10,5 mm  
Ø 10,5 mm drillhole for connecting cable routing

Clip a scomparsa  
Hidden clip

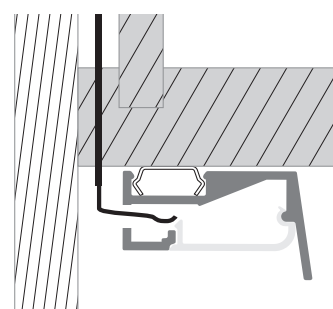
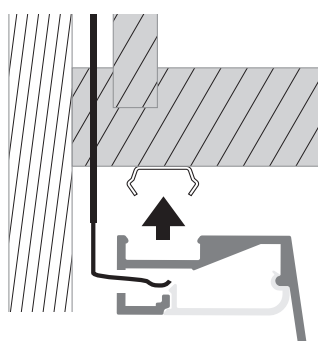
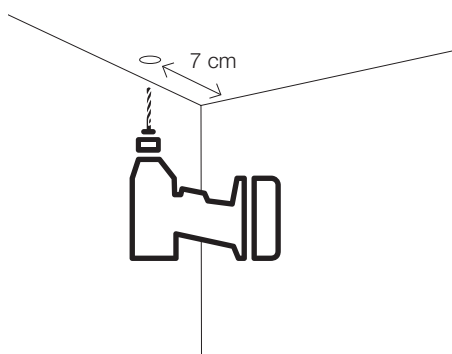

## CODICI - ITEM CODES

CODICE ITEM CODE	DESCRIZIONE DESCRIPTION	CE	UL	III	III	IP20	LUNGH mm LENGTH mm	WATT/h	VOLT
08616057A	WING 300mm GRIGIO ORIONE	DUAL COLOR 3000K - 4000K	TOUCH BUTTON	DESTRO	300	4.5	24 V		
08616057B	WING 450mm GRIGIO ORIONE	DUAL COLOR 3000K - 4000K	TOUCH BUTTON	DESTRO	450	7	24 V		
08616057C	WING 600mm GRIGIO ORIONE	DUAL COLOR 3000K - 4000K	TOUCH BUTTON	DESTRO	600	9	24 V		
08616057D	WING 900mm GRIGIO ORIONE	DUAL COLOR 3000K - 4000K	TOUCH BUTTON	DESTRO	900	13,5	24 V		
08616057E	WING 1200mm GRIGIO ORIONE	DUAL COLOR 3000K - 4000K	TOUCH BUTTON	DESTRO	1200	18	24 V		
08616057F	WING 1500mm GRIGIO ORIONE	DUAL COLOR 3000K - 4000K	TOUCH BUTTON	DESTRO	1500	23	24 V		
08616057G	WING 1800mm GRIGIO ORIONE	DUAL COLOR 3000K - 4000K	TOUCH BUTTON	DESTRO	1800	27	24 V		
08616057H	WING 2100mm GRIGIO ORIONE	DUAL COLOR 3000K - 4000K	TOUCH BUTTON	DESTRO	2100	32	24 V		
08616057J	WING 2400mm GRIGIO ORIONE	DUAL COLOR 3000K - 4000K	TOUCH BUTTON	DESTRO	2400	36	24 V		
08616057K	WING 2700mm GRIGIO ORIONE	DUAL COLOR 3000K - 4000K	TOUCH BUTTON	DESTRO	2700	41	24 V		
08616057L	WING 3000mm GRIGIO ORIONE	DUAL COLOR 3000K - 4000K	TOUCH BUTTON	DESTRO	3000	45	24 V		
08616058A	WING 300mm ARGENTO	DUAL COLOR 3000K - 4000K	TOUCH BUTTON	DESTRO	300	4.5	24 V		
08616058B	WING 450mm ARGENTO	DUAL COLOR 3000K - 4000K	TOUCH BUTTON	DESTRO	450	7	24 V		
08616058C	WING 600mm ARGENTO	DUAL COLOR 3000K - 4000K	TOUCH BUTTON	DESTRO	600	9	24 V		
08616058D	WING 900mm ARGENTO	DUAL COLOR 3000K - 4000K	TOUCH BUTTON	DESTRO	900	13,5	24 V		
08616058E	WING 1200mm ARGENTO	DUAL COLOR 3000K - 4000K	TOUCH BUTTON	DESTRO	1200	18	24 V		
08616058F	WING 1500mm ARGENTO	DUAL COLOR 3000K - 4000K	TOUCH BUTTON	DESTRO	1500	23	24 V		
08616058G	WING 1800mm ARGENTO	DUAL COLOR 3000K - 4000K	TOUCH BUTTON	DESTRO	1800	27	24 V		
08616058H	WING 2100mm ARGENTO	DUAL COLOR 3000K - 4000K	TOUCH BUTTON	DESTRO	2100	32	24 V		
08616058J	WING 2400mm ARGENTO	DUAL COLOR 3000K - 4000K	TOUCH BUTTON	DESTRO	2400	36	24 V		
08616058K	WING 2700mm ARGENTO	DUAL COLOR 3000K - 4000K	TOUCH BUTTON	DESTRO	2700	41	24 V		
08616058L	WING 3000mm ARGENTO	DUAL COLOR 3000K - 4000K	TOUCH BUTTON	DESTRO	3000	45	24 V		

comprendono un cavo di collegamento L.280 cm al trasformatore.  
include a 280cm connecting cable to the power supply.

N.B.: la luce può essere inserita anche sotto lo scolapiatti  
Note: the light can be insert under palte-rack unit

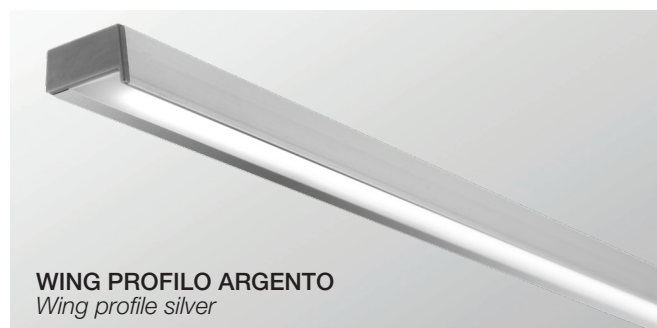
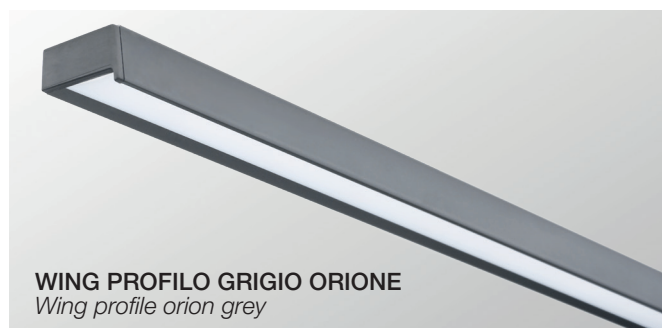

**KIT MONTAGGIO**  
Mounting kit



### ALIMENTATORI NON INCLUSI, DA ORDINARE SEPARATAMENTE

Scegliere l'alimentatore in relazione al consumo totale in Watt delle lampade LED.  
Si consiglia di tenere un margine di sicurezza di circa 10% rispetto alla potenza massima del trasformatore.

### POWER SUPPLIES NOT INCLUDED TO BE ORDERED SEPARATELY

Please choose the adequate power supply considering the total power consumption in Watt.  
It is recommended to keep a 10% safety margin below the maximum power output of the power supply.

PER ALIMENTATORI VERSIONE EU VEDI PAG. 60

PER ALIMENTATORI VERSIONE UL VEDI PAG. 61

FOR POWER SUPPLIES EU VERSION SEE PAGE 60

FOR POWER SUPPLIES UL VERSION SEE PAGE 61

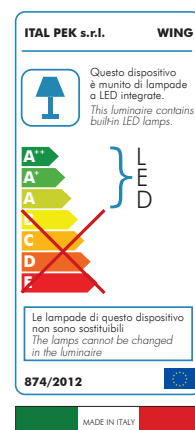

# SLIDE

basi con ante e/o cestoni  
base units with doors and/or deep drawers



SLIDE, sottilissima ed essenziale, è ideale per illuminare basi con ante, cassetti e cestoni. Lo spessore di soli 11 mm permette il montaggio anche tra gola e cassetto portaposate, senza perdere la luce che raggiunge l'interno del cestone inferiore aperto. Il fissaggio laterale diventa semplicissimo, grazie ai supporti da avvitare sui fianchi, per poi agganciare facilmente il corpo lampada. Il sensore di accensione alloggiato nel profilo permette di cambiare con facilità il colore del LED da caldo 3000K a naturale 4000K e viceversa.

*SLIDE, very thin and simple, is the perfect solution to light base units with doors pull-outs and drawers. The 11-mm thickness allows installation even between the groove and the cutlery drawer, with the light reaching the inside of the pull-out below. The lateral fixing is very simple thanks to the supports which only need to be screwed on the sides. You can then easily hook the lamp body on them. The sensor, is housed in the aluminium profile and allows you to easily change the LED colour temperature from warm white 3000K to natural white 4000K and viceversa.*

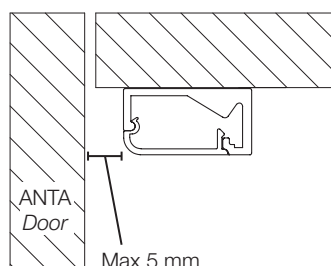
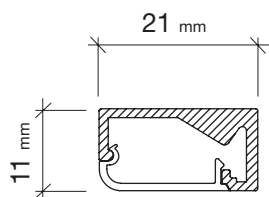

240 LED DUAL COLOR (120 +120 LED/m)

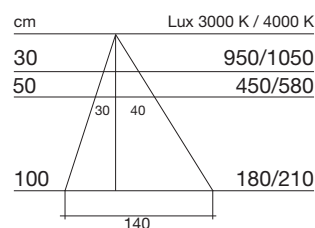

Il valore in LUX indicato è riferito ad una barra L=1200 mm  
Values in LUX refer to 1200 mm long lighting units

## Caratteristiche tecniche

profilo	grigio orione
diffusore	policarbonato opalino
fissaggio	mediante slitte laterali
lunghezza profilo	da 413 mm a 1163 mm
LED	120 + 120 LED/metro - 12 W/m
colore luce temperatura	DUAL COLOR_3000K - 4000K
alimentazione	24V - DC
lunghezza cavo	cavetto 300 mm + cavo da 2800 mm con connettori
caratteristica	luce continua, senza punti LED, senza interruzioni
certificazione fotobiologica	classe 0
resa cromatica	CRI>80
certificazioni	CE + UL

## Technical features

profile	orion grey
diffuser	opal polycarbonate
fastening	by means of side sliding brackets
profile length	from 413 mm up to 1163 mm
LED	120 + 120 LED/metro - 12 W/m
colour temperature	DUAL COLOR_3000K - 4000K
power supply	24V - DC
cable length	300 mm cable + 2800 mm extension cable
light features	uniform and seamless light, without interruptions
photobiological safety	RG (risk group) 0
chromaticity Index	CRI>80
compliance	CE + UL

## CODICI - ITEM CODES

CODICE ITEM CODE	DESCRIZIONE DESCRIPTION				BASE mm WATT/h VOLT		
					BASE UNIT mm		
08616312	SLIDE 413mm GRIGIO ORIONE	DUAL COLOR 3000K - 4000K	SENSORE DESTRO	450	5	24 V	
08616313	SLIDE 563mm GRIGIO ORIONE	DUAL COLOR 3000K - 4000K	SENSORE DESTRO	600	6,5	24 V	
08616315	SLIDE 863mm GRIGIO ORIONE	DUAL COLOR 3000K - 4000K	SENSORE DESTRO	900	10	24 V	
08616317	SLIDE 1163mm GRIGIO ORIONE	DUAL COLOR 3000K - 4000K	SENSORE DESTRO	1200	14	24 V	
<b>PER BASE A 2 ANTE / 2-DOOR BASE UNIT</b>							
08616316	SLIDE 863mm GRIGIO ORIONE	DUAL COLOR 3000K - 4000K	2 SENSORI	900	11	24 V	
08616318	SLIDE 1163mm GRIGIO ORIONE	DUAL COLOR 3000K - 4000K	2 SENSORI	1200	14	24 V	

comprendono un cavo di collegamento L.280cm al trasformatore.  
include a 280cm connecting cable to the power supply.

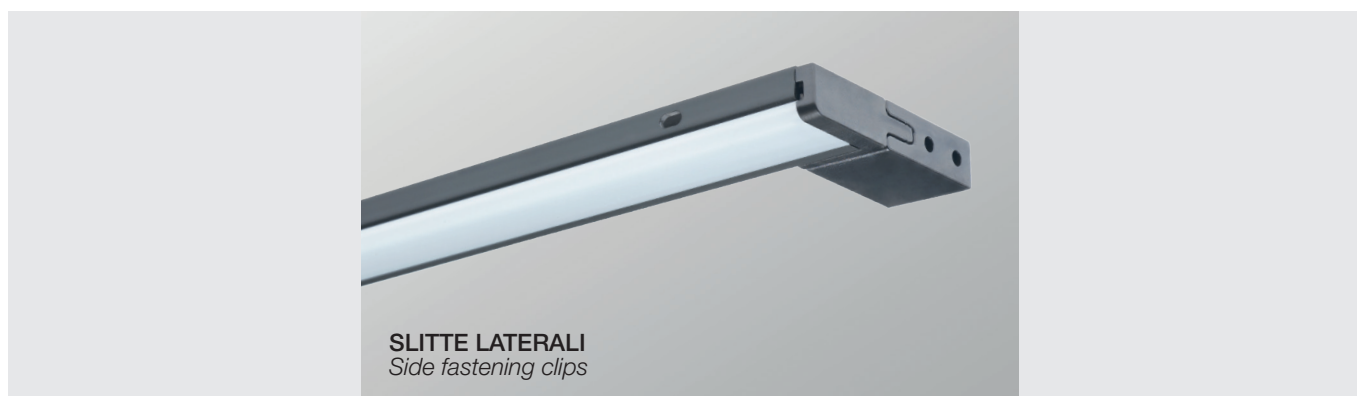

### SENSORE DI PROSSIMITÀ INTEGRATO

Si consiglia di installare la lampada non più distante di 5 mm dall'anta o frontalino. Qualora l'anta restasse involontariamente aperta il sensore spegne la lampada dopo 12 ore. In presenza di due ante battenti, è necessario ordinare il modello con 2 sensori ad entrambi i lati.

### INTEGRATED PROXIMITY SENSOR

We recommend installing the lighting unit not farther than 5 mm from the door or front. If the door is left open, accidentally or intentionally, the sensor switches off after 12 hours. In case of base units with two hinged doors, it is necessary to install a lighting unit with two sensors at both sides.

### ALIMENTATORI NON INCLUSI, DA ORDINARE SEPARATAMENTE

Scegliere l'alimentatore in relazione al consumo totale in Watt delle lampade LED.  
Si consiglia di tenere un margine di sicurezza di circa 10% rispetto alla potenza massima del trasformatore.

### POWER SUPPLIES NOT INCLUDED TO BE ORDERED SEPARATELY

Please choose the adequate power supply considering the total power consumption in Watt.  
It is recommended to keep a 10% safety margin below the maximum power output of the power supply.

PER ALIMENTATORI VERSIONE EU VEDI PAG. 60

PER ALIMENTATORI VERSIONE UL VEDI PAG. 61

FOR POWER SUPPLIES EU VERSION SEE PAGE 60

FOR POWER SUPPLIES UL VERSION SEE PAGE 61

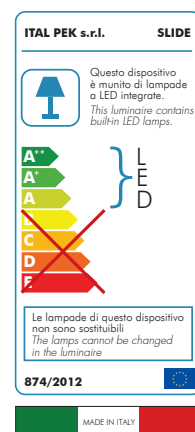

# SLIDE

interno pensile con ante battenti  
inside wall unit with hinged doors

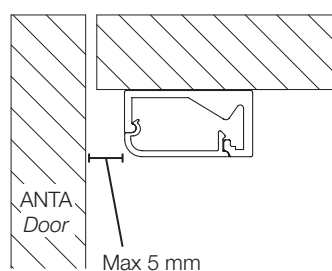
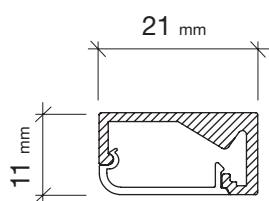

240 LED DUAL COLOR (120 +120 LED/m)

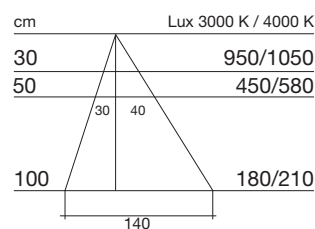

Il valore in LUX indicato è riferito ad una barra L=1200 mm  
Values in LUX refer to 1200 mm long lighting units

## Caratteristiche tecniche

profilo	grigio orione
diffusore	polycarbonato opalino
fissaggio	mediante viti
lunghezza profilo	da 413 mm a 1163 mm
LED	120 + 120 LED/metro - 12W/m
colore luce temperatura	DUAL COLOR_3000K - 4000K
alimentazione	24V - DC
lunghezza cavo	cavetto 300 mm + cavo da 2800 mm con connettori
caratteristica	luce continua, senza punti LED, senza interruzioni
certificazione fotobiologica	classe 0
resa cromatica	CRI>80
certificazioni	CE + UL

## Technical features

profile	orion grey
diffuser	opal polycarbonate
fastening	by means of hidden screws
profile length	from 413 mm up to 1163 mm
LED	120 + 120 LED/metro - 12W/m
colour temperature	DUAL COLOR_3000K - 4000K
power supply	24V - DC
cable length	300 mm cable + 2800 mm extension cable
light features	uniform and seamless light, without interruptions
photobiological safety	RG (risk group) 0
chromaticity Index	CRI>80
compliance	CE + UL



## CODICI - ITEM CODES

CODICE ITEM CODE	DESCRIZIONE DESCRIPTION				PENSILE mm WATT/h VOLT		
					CABINET mm		
08616302	SLIDE 413mm GRIGIO ORIONE	DUAL COLOR 3000K - 4000K	SENSORE DESTRO	450	5	24 V	
08616303	SLIDE 563mm GRIGIO ORIONE	DUAL COLOR 3000K - 4000K	SENSORE DESTRO	600	6,5	24 V	

### PER PENSILE A 2 ANTE / 2 DOORS WALL UNIT

08616306	SLIDE 863mm GRIGIO ORIONE	DUAL COLOR 3000K - 4000K	2 SENSORI	900	11	24 V
----------	---------------------------	--------------------------	-----------	-----	----	------

comprendono un cavo di collegamento L.280cm al trasformatore.  
include a 280cm connecting cable to the power supply.



### SENSORE DI PROSSIMITÀ INTEGRATO

Si consiglia di installare la lampada non più distante di 5 mm dall'anta o frontalino. Qualora l'anta restasse involontariamente aperta il sensore spegne la lampada dopo 12 ore. In presenza di due ante battenti, è necessario ordinare il modello con 2 sensori ad entrambi i lati.

### INTEGRATED PROXIMITY SENSOR

We recommend installing the lighting unit not farther than 5 mm from the door or front. If the door is left open, accidentally or intentionally, the sensor switches off after 12 hours. In case of base units with two hinged doors, it is necessary to install a lighting unit with two sensors at both sides.

### ALIMENTATORI NON INCLUSI, DA ORDINARE SEPARATAMENTE

Scegliere l'alimentatore in relazione al consumo totale in Watt delle lampade LED.  
Si consiglia di tenere un margine di sicurezza di circa 10% rispetto alla potenza massima del trasformatore.

### POWER SUPPLIES NOT INCLUDED TO BE ORDERED SEPARATELY

Please choose the adequate power supply considering the total power consumption in Watt.  
It is recommended to keep a 10% safety margin below the maximum power output of the power supply.

PER ALIMENTATORI VERSIONE EU VEDI PAG. 60

PER ALIMENTATORI VERSIONE UL VEDI PAG. 61

FOR POWER SUPPLIES EU VERSION SEE PAGE 60

FOR POWER SUPPLIES UL VERSION SEE PAGE 61

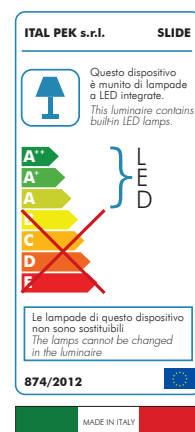

# MICRO sottopensile / under wall unit

MICRO, come dice il nome, è un profilo da incasso in policarbonato di piccolissime dimensioni 9,2 mm - H 10,8 mm. Nasce dall'esigenza di incassare in spessori minimi una luce continua, senza punti LED visibili, che si possa guardare direttamente senza esserne disturbati. Indicato per illuminare l'area sottopensile, ripiani e mensole. Il touch button integrato accende, spegne, regola l'intensità e permette di cambiare la tonalità della luce da calda 3000K a naturale 4000K e viceversa.

*MICRO, as its name suggests, is an extremely small recessed polycarbonate profile, dimensions 9,2 mm - H 10,8 mm. It was created as a way to provide a seamless light in thin panels without visible LED points, which could be looked at directly without issues. Perfect for installation under wall units or shelves. The integrated touch button allows you to switch the light on and off, adjusts its intensity, and change its tone from warm white 3000K to natural white 4000K and viceversa.*

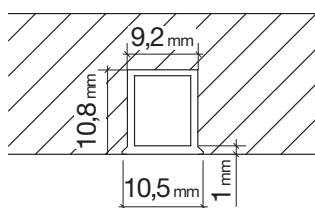

360 LED DUAL COLOR (180 +180 LED/m)

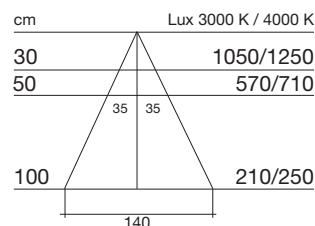

Il valore in LUX indicato è riferito ad una barra L=1200 mm  
Values in LUX refer to 1200 mm long lighting units

## Caratteristiche tecniche

diffusore	policarbonato opalino
fissaggio	a pressione e/o con gocce di adesivo
lunghezza profilo	da 413 mm a 1163 mm
LED	180 + 180 LED/m 14,4 W/m
colore luce temperatura	DUAL COLOR 3000K - 4000K
alimentazione	24V - DC
lunghezza cavo	cavetto 300 mm + cavo da 2800 mm con connettori
caratteristica	luce continua, senza interruzioni
certificazione fotobiologica	classe 0
resa cromatica	CRI>80
certificazioni	CE + UL

## Technical features

diffuser	opal polycarbonate
fastening	press fitting and/or with some glue drops
profile length	from 413 mm up to 1163 mm
LED	180 + 180 LED/m 14,4 W/m
colour temperature	DUAL COLOR 3000K - 4000K
power supply	24V - DC
cable length	300 mm cable + 2800 mm extension cable
light features	uniform and seamless light
photobiological safety	RG (risk group) 0
chromaticity Index	CRI>80
compliance	CE + UL

## CODICI - ITEM CODES

CODICE ITEM CODE	DESCRIZIONE DESCRIPTION	CE UL III F IP20	PENSILE mm CABINET mm	WATT/h	VOLT
08616400	MICRO 413mm	DUAL COLOR 3000K - 4000K TOUCH BUTTON	450	6	24 V
08616401	MICRO 563mm	DUAL COLOR 3000K - 4000K TOUCH BUTTON	600	8	24 V
08616402	MICRO 613mm	DUAL COLOR 3000K - 4000K TOUCH BUTTON	650	9	24 V
08616403	MICRO 763mm	DUAL COLOR 3000K - 4000K TOUCH BUTTON	800	11	24 V
08616404	MICRO 863mm	DUAL COLOR 3000K - 4000K TOUCH BUTTON	900	12,5	24 V
08616405	MICRO 1163mm	DUAL COLOR 3000K - 4000K TOUCH BUTTON	1200	16,5	24 V

comprendono un cavo di collegamento L.280cm al trasformatore.  
include a 280cm connecting cable to the power supply.



### TOUCH BUTTON

Il touch button posizionato a destra funziona al rilascio del dito.  
A lampada spenta un piccolo LED bianco dietro il diffusore ne segnala la posizione, a lampada accesa il LED bianco si spegne.

### FUNZIONAMENTO

- 1 - toccando il touch button la lampada si accende al 100%;
- 2 - toccando di nuovo il touch button la luminosità si riduce al 50%;
- 3 - tenendo il dito sul touch button si regola l'intensità (dimmer);
- 4 - toccando il touch button la lampada si spegne.

### CAMBIO COLORE

A lampada spenta, tenendo il dito fermo sul touch LED per almeno 20 secondi, il colore della luce cambia da bianco caldo 3000K a naturale 4000K o viceversa.

Il touch button memorizza l'ultima posizione impostata.  
Dopo un blackout la lampada ritorna nella stessa posizione in cui si trovava prima dello spegnimento.

**Tutte le nostre lampade con touch button possono essere comandate da un interruttore esterno.**

### TOUCH BUTTON

The touch button on the right side works as a touch-and-release button.  
When the lighting unit is off, a white LED behind the diffuser indicates the position of the touch button. This goes off when the unit is turned on.

### FUNCTIONING

- 1 - touching the touch button light turns on at 100%;
- 2 - touching it again the brightness is reduced at 50%;
- 3 - holding the finger on the touch button light is dimmed;
- 4 - touching the touch button light turns off.

### LED COLOUR CHANGE

With the light off, hold a finger on the touch button for at least 20 seconds.  
LED colour temperature changes from 3000K (warm) to 4000K (natural) and viceversa.

The touch button saves the last position set.  
After a power cut, the light returns to the same position as it had been set before the power outage.

**All our lighting units with touch button can be turned on and off via an external switch.**

### ALIMENTATORI NON INCLUSI, DA ORDINARE SEPARATAMENTE

Scegliere l'alimentatore in relazione al consumo totale in Watt delle lampade LED.  
Si consiglia di tenere un margine di sicurezza di circa 10% rispetto alla potenza massima del trasformatore.

### POWER SUPPLIES NOT INCLUDED TO BE ORDERED SEPARATELY

Please choose the adequate power supply considering the total power consumption in Watt.  
It is recommended to keep a 10% safety margin below the maximum power output of the power supply.

PER ALIMENTATORI VERSIONE EU VEDI PAG. 60

PER ALIMENTATORI VERSIONE UL VEDI PAG. 61

FOR POWER SUPPLIES EU VERSION SEE PAGE 60

FOR POWER SUPPLIES UL VERSION SEE PAGE 61

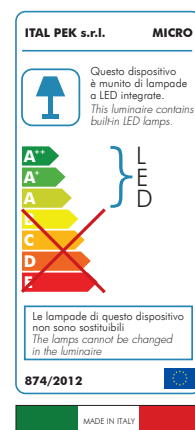

# FLUX\_9 orizzontale per mensole / horizontal for shelves



FLUX\_9 è incassata a filo sotto mensole/ripiani e grazie all'angolazione direziona la luce nella zona sottostante, senza che se ne percepisca la sorgente luminosa. Realizzata in due colori, nero e opale, è integrata perfettamente nel pannello con un'estetica sobria e minimale.

*Recessed under shelves, thanks to the angled, FLUX\_9 is invisible yet directs the light in the area below the worktop below. The opal and black polycarbonate profile, with its elegant and simple design, perfectly integrates into the panel.*

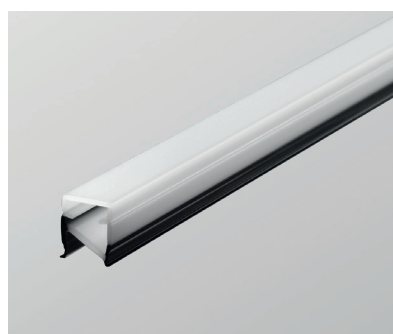
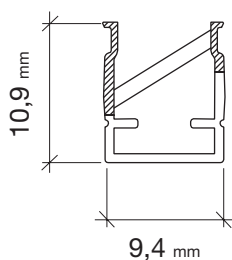

360 LED DUAL COLOR (180 +180 LED/m)

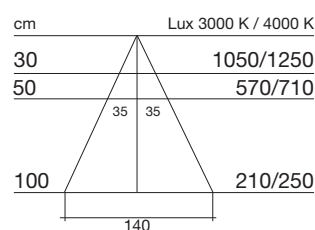

Il valore in LUX indicato è riferito ad una barra L=1200 mm  
Values in LUX refer to 1200 mm long lighting units

## Caratteristiche tecniche

diffusore	policarbonato coestruso opalino + nero
fissaggio	a pressione
lunghezza profilo	da 413 mm a 1163 mm
LED	180 + 180 LED/m 14,4 W/m
colore luce temperatura	DUAL COLOR 3000K - 4000K
alimentazione	24V - DC
lunghezza cavo	cavetto 300 mm + cavo da 2800 mm con connettori
caratteristica	luce continua, senza interruzioni
certificazione fotobiologica	classe 0
resa cromatica	CRI>80
certificazioni	CE + UL

## Technical features

diffuser	coextruded opal polycarbonate + black
fastening	press fitting
profile length	from 413 mm up to 1163 mm
LED	180 + 180 LED/m 14,4 W/m
colour temperature	DUAL COLOR 3000K - 4000K
power supply	24V - DC
cable length	300 mm cable + 2800 mm extension cable
light features	uniform and seamless light
photobiological safety	RG (risk group) 0
chromaticity Index	CRI>80
compliance	CE + UL

## CODICI - ITEM CODES

CODICE ITEM CODE	DESCRIZIONE DESCRIPTION	CE	UL	III	F	IP20	MENSOLA mm WATT/h VOLT		
							SHELF mm		
08616420	FLUX_9 260mm	ORIZZONTALE	DUAL COLOR 3000K - 4000K	300	4	24 V			
08616421	FLUX_9 410mm	ORIZZONTALE	DUAL COLOR 3000K - 4000K	450	6	24 V			
08616422	FLUX_9 560mm	ORIZZONTALE	DUAL COLOR 3000K - 4000K	600	8	24 V			
08616423	FLUX_9 860mm	ORIZZONTALE	DUAL COLOR 3000K - 4000K	900	12	24 V			
08616424	FLUX_9 1160mm	ORIZZONTALE	DUAL COLOR 3000K - 4000K	1200	17	24 V			
08616425	FLUX_9 1460mm	ORIZZONTALE	DUAL COLOR 3000K - 4000K	1500	21	24 V			
08616426	FLUX_9 1760mm	ORIZZONTALE	DUAL COLOR 3000K - 4000K	1800	25	24 V			
08616427	FLUX_9 2060mm	ORIZZONTALE	DUAL COLOR 3000K - 4000K	2100	30	24 V			
08616428	FLUX_9 2360mm	ORIZZONTALE	DUAL COLOR 3000K - 4000K	2400	34	24 V			
08616429	FLUX_9 2660mm	ORIZZONTALE	DUAL COLOR 3000K - 4000K	2700	38	24 V			
08616430	FLUX_9 2960mm	ORIZZONTALE	DUAL COLOR 3000K - 4000K	3000	43	24 V			

comprendono un cavo di collegamento L.280cm al trasformatore e un cavetto per cambio del colore LED.  
include a 280cm connecting cable to the power supply and adapter for LED change.



CAVETTO CAMBIO COLORE LED  
Adapter for LED colour change

## COMANDI DI ACCENSIONE / CONTROLS

**RICEVITORE DIMMER**  
*Dimmer receiver*

RICEVITORE DIMMER / Dimmer receiver			
<b>CODICE</b> ITEM CODE	08616077		

**RADIOCOMANDO 4-ZONE**  
*Wireless 4-zone control*

RADIOCOMANDO 4-ZONE / Wireless 4-zone control			
<b>CODICE</b> ITEM CODE	08616183		

COMANDI DI ACCENSIONE dettagli vedi pag **62**  
CONTROLS details page **62**

### ALIMENTATORI NON INCLUSI, DA ORDINARE SEPARATAMENTE

Scegliere l'alimentatore in relazione al consumo totale in Watt delle lampade LED.  
Si consiglia di tenere un margine di sicurezza di circa 10% rispetto alla potenza massima del trasformatore.

### POWER SUPPLIES NOT INCLUDED TO BE ORDERED SEPARATELY

Please choose the adequate power supply considering the total power consumption in Watt.  
It is recommended to keep a 10% safety margin below the maximum power output of the power supply.

PER ALIMENTATORI VERSIONE EU VEDI PAG. **60**

PER ALIMENTATORI VERSIONE UL VEDI PAG. **61**

FOR POWER SUPPLIES EU VERSION SEE PAGE 60

FOR POWER SUPPLIES UL VERSION SEE PAGE 61



ITAL PEK s.r.l. **FLUX\_9**

Questo dispositivo è munito di lampade a LED integrate.  
This luminaire contains built-in LED lamps.

Le lampade di questo dispositivo non sono sostituibili.  
The lamps cannot be changed in the luminaire.

874/2012

MADE IN ITALY

# FLUX\_9

verticale interno pensili e colonne  
vertical inside wall units and columns

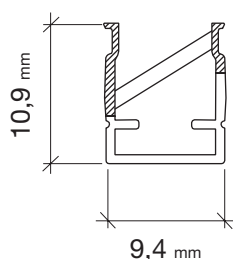

360 LED DUAL COLOR (180 +180 LED/m)

cm	Lux 3000 K / 4000 K
30	1050/1250
50	570/710
100	210/250

140

Il valore in LUX indicato è riferito ad una barra L=1200 mm  
Values in LUX refer to 1200 mm long lighting units

## Caratteristiche tecniche

diffusore	polycarbonato coestruso opalino + nero
fissaggio	a pressione
lunghezza profilo	da 413 mm a 1163 mm
LED	180 + 180 LED/m 14,4 W/m
colore luce temperatura	DUAL COLOR 3000K - 4000K
alimentazione	24V - DC
lunghezza cavo	cavetto 300 mm + cavo da 2800 mm con connettori
caratteristica	luce continua, senza interruzioni
certificazione fotobiologica	classe 0
resa cromatica	CRI>80
certificazioni	CE + UL

## Technical features

diffuser	coextruded opal polycarbonate + black
fastening	press fitting
profile length	from 413 mm up to 1163 mm
LED	180 + 180 LED/m 14,4 W/m
colour temperature	DUAL COLOR 3000K - 4000K
power supply	24V - DC
cable length	300 mm cable + 2800 mm extension cable
light features	uniform and seamless light
photobiological safety	RG (risk group) 0
chromaticity index	CRI>80
compliance	CE + UL

# CODICI - ITEM CODES

## H PENSILE

H WALL UNIT

H COLONNA mm

H TALL UNIT mm

WATT/h VOLT

CODICE ITEM CODE	DESCRIZIONE DESCRIPTION	CE	UL	III	IP20	SINISTRO/ DESTRO	360	4,5	24 V
08616435	FLUX_9 323mm	VERTICALE	DUAL COLOR 3000K - 4000K	SINISTRO/ DESTRO	360	4,5	24 V		
08616436	FLUX_9 443mm	VERTICALE	DUAL COLOR 3000K - 4000K	SINISTRO/ DESTRO	480	6	24 V		
08616437	FLUX_9 563mm	VERTICALE	DUAL COLOR 3000K - 4000K	SINISTRO/ DESTRO	600	8	24 V		
08616438	FLUX_9 683mm	VERTICALE	DUAL COLOR 3000K - 4000K	SINISTRO/ DESTRO	720	10	24 V		
08616439	FLUX_9 923mm	VERTICALE	DUAL COLOR 3000K - 4000K	SINISTRO/ DESTRO	960	13	24 V		
08616440	FLUX_9 1043mm	VERTICALE	DUAL COLOR 3000K - 4000K	SINISTRO/ DESTRO	1080	15	24 V		
08616441	FLUX_9 1163mm	VERTICALE	DUAL COLOR 3000K - 4000K	SINISTRO/ DESTRO	1200	16,5	24 V		
08616442	FLUX_9 1283mm	VERTICALE	DUAL COLOR 3000K - 4000K	SINISTRO/ DESTRO	1320	18	24 V		
08616443	FLUX_9 1403mm	VERTICALE	DUAL COLOR 3000K - 4000K	SINISTRO/ DESTRO	1440	20	24 V		
08616444	FLUX_9 2003mm	VERTICALE	DUAL COLOR 3000K - 4000K	SINISTRO/ DESTRO	2040	29	24 V		
08616445	FLUX_9 2123mm	VERTICALE	DUAL COLOR 3000K - 4000K	SINISTRO/ DESTRO	2160	31	24 V		
08616446	FLUX_9 2243mm	VERTICALE	DUAL COLOR 3000K - 4000K	SINISTRO/ DESTRO	2280	32	24 V		
* 08616453	FLUX_9 693mm	VERTICALE	DUAL COLOR 3000K - 4000K	SINISTRO/ DESTRO		10	24 V		
* 08616455	FLUX_9 813mm	VERTICALE	DUAL COLOR 3000K - 4000K	SINISTRO/ DESTRO		11,5	24 V		
* 08616456	FLUX_9 933mm	VERTICALE	DUAL COLOR 3000K - 4000K	SINISTRO/ DESTRO		13,5	24 V		
* 08616457	FLUX_9 1293mm	VERTICALE	DUAL COLOR 3000K - 4000K	SINISTRO/ DESTRO		18,5	24 V		
* 08616458	FLUX_9 1413mm	VERTICALE	DUAL COLOR 3000K - 4000K	SINISTRO/ DESTRO		20,5	24 V		
* 08616459	FLUX_9 1533mm	VERTICALE	DUAL COLOR 3000K - 4000K	SINISTRO/ DESTRO		22	24 V		

comprendono un cavo di collegamento L.280cm al trasformatore e un cavetto per cambio del colore LED. *The above include a 280cm connecting cable to the power supply and adapter for LED change.*

\* Per colonne 2 vani  
For 2 compartments columns



CAVETTO CAMBIO COLORE LED  
Adapter for LED colour change

## COMANDI DI ACCENSIONE / CONTROLS

### LASER BACK PER SCHIENALE

Viene avvitato nella parte superiore dello schienale ad una distanza massima di 70 cm dall'anta. All'apertura e chiusura dell'anta accende e spegne le lampade.

### BACKPANEL LASER SENSOR

It is easily screwed to the upper side of the back panel at a maximum distance of 70 cm from the door. Every time the doors are opened and closed, the light turns on and off.

CODICE ITEM CODE	08616182	LASER SINGOLO 1 ANTA
CODICE ITEM CODE	08616186	LASER DOPPIO 2 ANTE



CE UL

### RICEVITORE DIMMER Dimmer receiver



RICEVITORE DIMMER / Dimmer receiver	
CODICE ITEM CODE	08616077

### RADIOCOMANDO 4-ZONE Wireless 4-zone control



RADIOCOMANDO 4-ZONE / Wireless 4-zone control	
CODICE ITEM CODE	08616183

CE UL

COMANDI DI ACCENSIONE dettagli vedi pag 62 / CONTROLS details page 62

## ALIMENTATORI NON INCLUSI, DA ORDINARE SEPARATAMENTE

Scegliere l'alimentatore in relazione al consumo totale in Watt delle lampade LED. Si consiglia di tenere un margine di sicurezza di circa 10% rispetto alla potenza massima del trasformatore.

## POWER SUPPLIES NOT INCLUDED TO BE ORDERED SEPARATELY

Please choose the adequate power supply considering the total power consumption in Watt. It is recommended to keep a 10% safety margin below the maximum power output of the power supply.

PER ALIMENTATORI VERSIONE EU VEDI PAG. 60  
PER ALIMENTATORI VERSIONE UL VEDI PAG. 61  
FOR POWER SUPPLIES EU VERSION SEE PAGE 60  
FOR POWER SUPPLIES UL VERSION SEE PAGE 61

CE UL

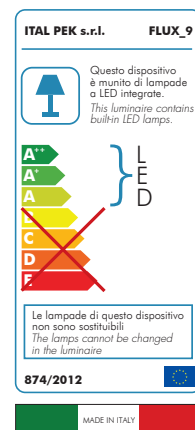

# GLASS\_8 ripiani vetro / glass shelves



GLASS\_8 è una lampada versatile e completa.

Il profilo estruso in policarbonato con aree colorate e diffusore opalino/nero può dirigere la luce in due o tre direzioni:

- 1) illumina in alto e in basso lo schienale del vano con un effetto soffuso (**il bordo del ripiano non è illuminato**)
- 2) illumina in alto e in basso lo schienale del vano con un effetto soffuso e retroillumina in profondità anche il ripiano in vetro senza avere punti LED visibili

*GLASS\_8 is a versatile and complete lamp.*

*The opal and black coextruded profile spreads the light in two or three directions:*

- 1) it is possible to illuminate both upwards and downwards the back of the compartment with a soft suffused effect (**there is not light through the glass edge**)
- 2) it is possible to illuminate both upwards and downwards the back of the compartment with a soft suffused effect and to light the glass shelf of cupboards, display cases, and bookcases without visible LED points

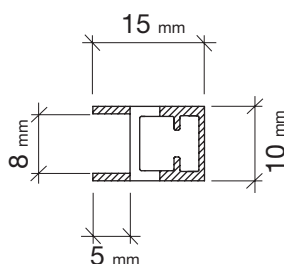
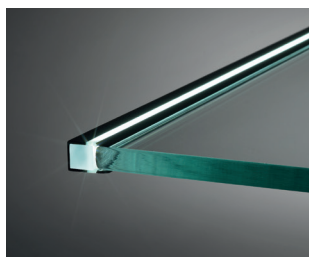

360 LED DUAL COLOR (180 +180 LED/m)

cm	Lux 3000 K / 4000 K
30	1050/1250
50	570/710
100	210/250

Il valore in LUX indicato è riferito ad una barra L=1200 mm  
Values in LUX refer to 1200 mm long lighting units

## Caratteristiche tecniche

diffusore	policarbonato opalino/nero
fissaggio	ad inserimento nello spessore del ripiano
lunghezza profilo	vedi tabella
LED	180 + 180 LED/m 14,4 W/m
colore luce temperatura	DUAL COLOR_3000K - 4000K
alimentazione	24V - DC
lunghezza cavo	cavetto 300 mm + cavo da 2800 mm con connettori
caratteristica	luce in due o tre direzioni
certificazione fotobiologica	classe 0
resa cromatica	CRI>80
certificazioni	CE + UL

## Technical features

diffuser	coextruded opal/black polycarbonate
fastening	press fitting
profile length	see table
LED	180 + 180 LED/m 14,4 W/m
colour temperature	DUAL COLOR_3000K - 4000K
power supply	24V - DC
cable length	300 mm cable + 2800 mm extension cable
light features	light in two or three directions
photobiological safety	RG (risk group) 0
chromaticity Index	CRI>80
compliance	CE + UL



# CODICI - ITEM CODES

CODICE ITEM CODE	DESCRIZIONE DESCRIPTION	CE	UL	III	IP20	WATT/h VOLT
08616260	GLASS_8 OPALE/NERO 107mm	DUAL COLOR 3000K - 4000 K	2	24 V		
08616261	GLASS_8 OPALE/NERO 257mm	DUAL COLOR 3000K - 4000 K	4	24 V		
08616262	GLASS_8 OPALE/NERO 357mm	DUAL COLOR 3000K - 4000 K	5	24 V		
08616263	GLASS_8 OPALE/NERO 407mm	DUAL COLOR 3000K - 4000 K	6	24 V		
08616264	GLASS_8 OPALE/NERO 557mm	DUAL COLOR 3000K - 4000 K	8	24 V		
08616265	GLASS_8 OPALE/NERO 607mm	DUAL COLOR 3000K - 4000 K	9	24 V		
08616266	GLASS_8 OPALE/NERO 757mm	DUAL COLOR 3000K - 4000 K	11	24 V		
08616267	GLASS_8 OPALE/NERO 857mm	DUAL COLOR 3000K - 4000 K	12	24 V		
08616268	GLASS_8 OPALE/NERO 1157mm	DUAL COLOR 3000K - 4000 K	17	24 V		
08616257	GLASS_8 OPALE/NERO 277mm	DUAL COLOR 3000K - 4000 K per elemento a giorno "CLASS" L 30	4	24 V		
08616258	GLASS_8 OPALE/NERO 427mm	DUAL COLOR 3000K - 4000 K per elemento a giorno "CLASS" L 45	6	24 V		

comprendono un cavo di collegamento L.280cm al trasformatore e cavetto per cambio del colore LED. *The above include a 280cm connecting cable to the power supply and an adapter for LED color change.*



**CAVETTO CAMBIO COLORE LED**  
Adapter for LED colour change

## TIPO DI UTILIZZO - TYPE OF USE

**SOLUZIONE 1\_Luce in due direzioni**  
**SOLUTION 1\_Light in two directions**

il bordo del ripiano NON viene illuminato  
there is NOT light through the glass edge

profilo nero di copertura  
black cover profile

**SOLUZIONE 2\_Luce in tre direzioni**  
**SOLUTION 2\_Light in three directions**

anche il bordo del ripiano viene illuminato  
the light is diffused also through the glass edge

bordo illuminato  
light through glass edge

### RICEVITORE DIMMER Dimmer receiver



RICEVITORE DIMMER / Dimmer receiver

<b>CODICE</b> ITEM CODE	08616077
----------------------------	----------

### RADIOCOMANDO 4-ZONE Wireless 4-zone control



RADIOCOMANDO 4-ZONE / Wireless 4-zone control

<b>CODICE</b> ITEM CODE	08616183
----------------------------	----------



COMANDI DI ACCENSIONE dettagli vedi pag **62**  
CONTROLS details page **62**

### ALIMENTATORI NON INCLUSI, DA ORDINARE SEPARATAMENTE

Scegliere l'alimentatore in relazione al consumo totale in Watt delle lampade LED.  
Si consiglia di tenere un margine di sicurezza di circa 10% rispetto alla potenza massima del trasformatore.

### POWER SUPPLIES NOT INCLUDED TO BE ORDERED SEPARATELY

Please choose the adequate power supply considering the total power consumption in Watt.  
It is recommended to keep a 10% safety margin below the maximum power output of the power supply.

**PER ALIMENTATORI VERSIONE EU VEDI PAG. 60**  
**PER ALIMENTATORI VERSIONE UL VEDI PAG. 61**  
FOR POWER SUPPLIES EU VERSION SEE PAGE 60  
FOR POWER SUPPLIES UL VERSION SEE PAGE 61



ITAL PEK s.r.l. GLASS\_8

Questo dispositivo è munito di lampade a LED integrate.  
This luminaire contains built-in LED lamps.

Le lampade di questo dispositivo non sono sostituibili.  
The lamps cannot be changed in the luminaire.

874/2012

MADE IN ITALY

# SPOT\_3328



SPOT\_3328 è un faretto a LED da incasso piccolo e sottile, disponibile nelle finiture grigio orione o bianco. Ideale per illuminare l'interno di pensili, colonne, ripiani o mensole. Il LED dual color 3000K - 4000K consente di scegliere la tonalità di luce preferita nel contesto da illuminare.

*SPOT\_3328 is a compact and very thin recessed LED spot available in orion grey or white. It is perfect inside wall units, columns and shelves. The 3000-4000K dual colour LED makes it possible to choose the preferred accent lighting that best suits the furniture finishing.*

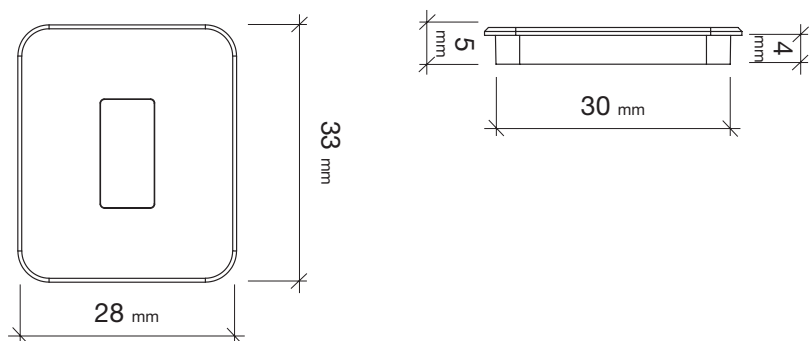

## Caratteristiche tecniche

corpo faretto	ABS
colori	bianco - grigio orione
assorbimento	1 Watt
colore luce temperatura	DUAL COLOR 3000K - 4000K
alimentazione	24V - DC
lunghezza cavo	cavetto 300 mm + cavo da 2800 mm con connettori
certificazione fotobiologica	classe 0
resa cromatica	CRI>80
grado di protezione	IP20
certificazioni	CE + UL

## Technical features

spot body	ABS
finishing	white / orion grey
power consumption	1 Watt
colour temperature	DUAL COLOR 3000K - 4000K
power supply	24V - DC
cable length	300 mm cable + 2800 mm extension cable
photobiological safety	RG (risk group) 0
chromaticity Index	CRI>80
protection degree	IP20
compliance	CE + UL

## CODICI - ITEM CODES

CODICE ITEM CODE	DESCRIZIONE DESCRIPTION	CE UL III F IP20	WATT/h	VOLT
08616175	SPOT_3328 FARETTO INCASSO BIANCO		1	24 V
08616176	SPOT_3328 FARETTO INCASSO GRIGIO ORIONE		1	24 V

comprendono un cavo di collegamento L.280cm al trasformatore e cavetto per cambio del colore LED. *The above include a 280cm connecting cable to the power supply and an adapter for LED color change.*



**CAVETTO CAMBIO COLORE LED**  
Adapter for LED colour change

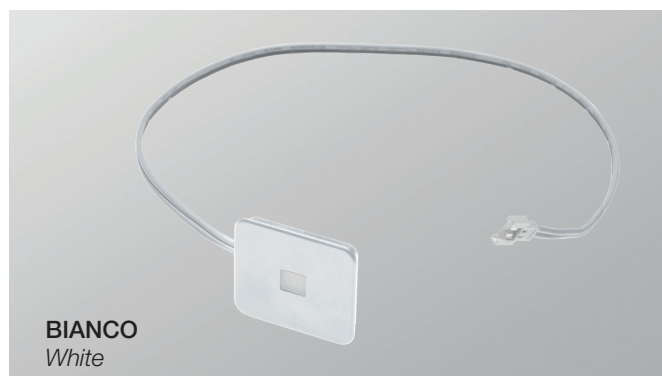

**BIANCO**  
White



**GRIGIO ORIONE**  
Orion grey

## COMANDI DI ACCENSIONE / CONTROLS

### LASER BACK PER SCHIENALE

Viene avvitato nella parte superiore dello schienale ad una distanza massima di 70 cm dall'anta. All'apertura e chiusura dell'anta accende e spegne le lampade.

### BACKPANEL LASER SENSOR

*It is easily screwed to the upper side of the back panel at a maximum distance of 70 cm from the door. Every time the doors are opened and closed, the light turns on and off.*

<b>CODICE</b> ITEM CODE	08616182	LASER SINGOLO 1 ANTA
<b>CODICE</b> ITEM CODE	08616186	LASER DOPPIO 2 ANTE



### RICEVITORE DIMMER Dimmer receiver



RICEVITORE DIMMER / Dimmer receiver		
<b>CODICE</b> ITEM CODE	08616077	

### RADIOCOMANDO 4-ZONE Wireless 4-zone control



RADIOCOMANDO 4-ZONE / Wireless 4-zone control		
<b>CODICE</b> ITEM CODE	08616183	

COMANDI DI ACCENSIONE dettagli vedi pag **62** / CONTROLS details page **62**

## ALIMENTATORI NON INCLUSI, DA ORDINARE SEPARATAMENTE

Scegliere l'alimentatore in relazione al consumo totale in Watt delle lampade LED. Si consiglia di tenere un margine di sicurezza di circa 10% rispetto alla potenza massima del trasformatore.

## POWER SUPPLIES NOT INCLUDED TO BE ORDERED SEPARATELY

*Please choose the adequate power supply considering the total power consumption in Watt. It is recommended to keep a 10% safety margin below the maximum power output of the power supply.*

PER ALIMENTATORI VERSIONE EU VEDI PAG. **60**

PER ALIMENTATORI VERSIONE UL VEDI PAG. **61**

FOR POWER SUPPLIES EU VERSION SEE PAGE **60**

FOR POWER SUPPLIES UL VERSION SEE PAGE **61**



**ITAL PEK s.r.l. SPOT\_3328**

Questo dispositivo è munito di lampade a LED integrate.  
*This luminaire contains built-in LED lamps.*

**A++**  
**A+**  
**A**  
**B**  
**C**  
**D**  
**E**

**LED**

Le lampade di questo dispositivo non sono sostituibili.  
*The lamps cannot be changed in the luminaire.*

874/2012

MADE IN ITALY



Codice / *Item no.* 08616190A  
 Input / *Output* 220 - 240 Vac / 24 V  
 Potenza / *Max Power* **20 W (0,84 A)**  
 Cavo input / *Input cable* L. 1,5 m spina CE / *CE plug*  
 Cavo output / *Output cable* 22 cm + distributore AMP 3 uscite / *3-out distributor box*  
 Dimensioni / *Dimensions* spessore max 20 mm / *thickness max 20 mm*  
 IP IP 20



Codice / *Item no.* 08616192A  
 Input / *Output* 220 - 240 Vac / 24 V  
 Potenza / *Max Power* **50 W (2,8 A)**  
 Cavo input / *Input cable* L. 1,5 m spina CE / *CE plug*  
 Cavo output / *Output cable* 22 cm + distributore AMP 6-uscite / *6-out distributor box*  
 Dimensioni / *Dimensions* spessore max 25 mm / *thickness max 25 mm*  
 IP IP 20



Codice / *Item no.* 08616195  
 Input / *Output* 220 - 240 Vac / 24 V  
 Potenza / *Max Power* **75 W (3,1 A)**  
 Cavo input / *Input cable* L. 1,5 m spina CE / *CE plug*  
 Cavo output / *Output cable* 22 cm + distributore AMP 6-uscite / *6-out distributor box*  
 Dimensioni / *Dimensions* spessore max 33 mm / *thickness max 33 mm*  
 IP IP 20



Codice / *Item no.* 08616201  
 Input / *Output* 220 - 240 Vac / 24 V  
 Potenza / *Max Power* **100 W (4,17 A)**  
 Cavo input / *Input cable* L. 1,5 m spina CE / *CE plug*  
 Cavo output / *Output cable* 22 cm + distributore AMP 6-uscite / *6-out distributor box*  
 Dimensioni / *Dimensions* spessore max 26 mm / *thickness max 26 mm*  
 IP IP 20



Codice / *Item no.* 08616202  
 Input / *Output* 220 - 240 Vac / 24 V  
 Potenza / *Max Power* **150 W (6,25 A)**  
 Cavo input / *Input cable* L. 1,5 m spina CE / *CE plug*  
 Cavo output / *Output cable* 22 cm + distributore AMP 6-uscite / *6-out distributor box*  
 Dimensioni / *Dimensions* spessore max 31 mm / *thickness max 31 mm*  
 IP IP 20

## IMPORTANTE: ALIMENTATORI NON INCLUSI, DA ORDINARE SEPARATAMENTE

Scegliere l'alimentatore in relazione al consumo totale in Watt delle lampade LED.  
 Si consiglia di tenere un margine di sicurezza di circa 10% rispetto alla potenza massima del trasformatore.

## IMPORTANT NOTICE: POWER SUPPLIES NOT INCLUDED TO BE ORDERED SEPARATELY

Please choose the adequate power supply considering the total power consumption in Watt.  
 It is recommended to keep a 10% safety margin below the maximum power output of the power supply.

# ALIMENTATORI *POWER SUPPLIES*



UL8750, UL1310, FCC 15A

**U.S. and CANADA**



Codice / *Item no.* 08616198  
Input / *Output* 100 - 120 Vac / 24 V  
Potenza / *Max Power* **30 W ( 1,25 A )**  
Cavo input / *Input cable* 1,5 m + spina USA "A" / 'A' USA plug  
Cavo output / *Output cable* 15 cm + DISTRIBUTORE AMP 6 vie / 6-out AMP distributor box  
Dimensioni / *Dimensions* spessore max 23 mm / *thickness max 23 mm*  
IP



Codice / *Item no.* 08616200  
Input / *Output* 100 - 120 Vac / 24 V  
Potenza / *Max Power* **75 W ( 3 A )**  
Cavo input / *Input cable* 1,5 m + spina USA "A" / 'A' USA plug  
Cavo output / *Output cable* 15 cm + DISTRIBUTORE AMP 6 vie / 6-out AMP distributor box  
Dimensioni / *Dimensions* spessore max 33 mm / *thickness max 33 mm*  
IP

## CAVI CABLES



Prolunga L= 280 cm universale per tutte le barre LED del catalogo da utilizzare in aggiunta al cavo di collegamento in caso di distanze maggiori tra barra e alimentatore.  
*280 cm extension cable*



**CODICE**  
*ITEM CODE*

08616180



**CODICE**  
*ITEM CODE*

08616181



Moltiplicatore di ingressi con cavo L= 20 cm  
Consente di collegare fino a 6 lampade per ogni ingresso dell'alimentatore.  
*Input multiplier with cable W= 20 cm*  
*Allows up to 6 lamps to be connected to each input of the power supply*

**CODICE**  
*ITEM CODE*

08616187

# LASER BACK

## SENSORE PER SCHIENALE

### BACKPANEL LASER SENSOR

BREVETTO/ Patent  
**ITAL PEK**  
ATELIER LED LIGHTING

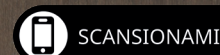
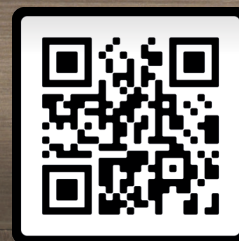

Può leggere ante in qualsiasi colore, finitura, materiale, compreso vetro. Le sue piccole dimensioni lo rendono idoneo per l'applicazione in appoggio contro lo schienale. Richiede un semplice foro per il passaggio dei cavi. Questo consente ai progettisti di scegliere qualsiasi modello di lampade a LED senza preoccuparsi della modalità di accensione e dello spegnimento della luce. In fase di installazione il montatore decide dove posizionarlo.

*It can detect any surface finishing, material and color, including glass. Its small dimensions make it suitable for the installation against the backpanel. It requires just a simple drillhole for the cable connection. This allows the furniture designer or dealer to choose whatever LED lighting profile, without any concern about the switch control of the light. The kitchen fitter can freely decide where to place it.*

#### DATI TECNICI

Dimensioni L 34 x 11,8 x 11,8 mm - Max 60 Watt - 24 Vdc.  
Viene fissato nella parte superiore dello schienale ad una distanza massima di 70 cm dall'anta. Comanda più lampade fino ad un massimo di 60 Watt totali. Alla prima installazione richiede una procedura di taratura. Nel raggio d'azione del Laser, per un suo corretto funzionamento, occorre lasciare uno spazio libero di 50mm in verticale e 80mm in orizzontale.  
**Per mobili a 2 ante, ordinare modello doppio LASER con cavo di collegamento.**

#### TECHNICAL DATA

Dimensions L 34 x 11,8 x 11,8 mm - Max 60 Watt - 24 Vdc.  
It is easily screwed to the upper side of the back panel at a maximum distance of 70 cm from the door. It can turn on and off more lighting units up to max 60 Watt. A simple setting procedure has to be carried out at its first connection. For its correct functioning, an area of 50mm vertically and 80mm horizontally must be kept free from objects.  
**For 2-door cabinets, a double sensor with connecting cable is required.**

LASER SINGOLO  
1 ANTA

**CODICE**  
ITEM CODE

08616182

LASER DOPPIO  
2 ANTE

**CODICE**  
ITEM CODE

08616186



#### RICEVITORE DIMMER

##### Dimmer receiver



#### RICEVITORE DIMMER

Dimensioni 145 x 46,5 x 16 mm  
Questo ricevitore 24Vdc deve essere collegato al trasformatore e comanda fino a 6 barre LED fino a max 180 Watt di assorbimento. Fare riferimento ai Watt dei LED indicati in tabella.

#### DIMMER RECEIVER

Dimensions 145 x 46,5 x 16 mm  
This 24Vdc device has to be connected to the power supply and can control up to 6 LED lights for a max power consumption of 180 Watt. Please refer to the Watt of each LED light in the table.

**CE** **CODICE**  
ITEM CODE

08616077

**UL** **CODICE**  
ITEM CODE

08616077UL

#### RADIOCOMANDO 4-ZONE

##### Wireless 4-zone control



#### RADIOCOMANDO WIRELESS 4-ZONE

##### (da abbinare a ricevitore dimmer)

Dimensioni 137 x 39 x 11 mm  
Con questo radiocomando si possono comandare fino a 4 ricevitori insieme o in modo separato per creare 4 zone di illuminazione. Consente di accendere, spegnere e regolare la luminosità di ogni zona singolarmente o in una unica soluzione.

#### WIRELESS 4-ZONE CONTROL

##### (to be paired to dimmer receiver)

Dimensions 137 x 39 x 11 mm  
This wireless radiocomando can be paired to max 4 dimmer receivers, thus creating 4 lighting areas. It allows to turn on, off and adjust the light intensity of each area distinctly or all together.

**CODICE**  
ITEM CODE

08616183

